

## Junior Engineer Civil Mechanical and Electrical Examination 2024 Paper I

Exam Date	07/06/2024
Exam Time	9:00 AM - 11:00 AM
Subject	Junior Engineer 2024 Civil Paper I

### Section : General Intelligence and Reasoning

Q.1 How many triangles are there in the given figure?

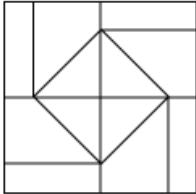

- Ans
- 1. 4
  - 2. 6
  - 3. 8
  - 4. 10

Q.2 In a certain code language, 'BEAR' is coded as '9715' and 'RUST' is coded as '8962'. What is the code for 'R' in that language?

- Ans
- 1. 9
  - 2. 6
  - 3. 5
  - 4. 8

Q.3 Select the set in which the numbers are related in the same way as are the numbers of the following sets.

(NOTE : Operations should be performed on the whole numbers, without breaking down the numbers into its constituent digits. E.g. 13 – Operations on 13 such as adding/deleting/multiplying etc. to 13 can be performed. Breaking down 13 into 1 and 3 and then performing mathematical operations on 1 and 3 is not allowed.)

(6, 24, 12)

(7, 36, 13)

- Ans
- 1. (11, 106, 5)
  - 2. (9, 66, 15)
  - 3. (5, 12, 18)
  - 4. (8, 49, 12)

Q4 Select the correct mirror image of the given figure when the mirror is placed at OG as shown below.

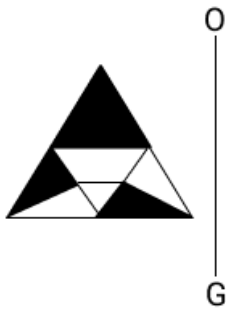

Ans

- 1.
- 2.
- 3.
- 4.

Q5 In a certain code language,  
 'A + B' means 'A is the brother of B',  
 'A - B' means 'A is the mother of B',  
 'A × B' means 'A is the wife of B' and  
 'A ÷ B' means 'A is the father of B'.  
 How is S related to M if 'N × S ÷ A + R - M'?

- Ans
- 1. Mother's father
  - 2. Father
  - 3. Brother's daughter
  - 4. Father's mother

Q6 Select the set in which the numbers are related in the same way as are the numbers of the following sets.  
 (NOTE: Operations should be performed on the whole numbers, without breaking down the numbers into its constituent digits. E.g. 13 - Operations on 13 such as adding/subtracting/multiplying etc. to 13 can be performed. Breaking down 13 into 1 and 3 and then performing mathematical operations on 1 and 3 is not allowed.)  
 (4, 32, 8)  
 (9, 54, 6)

- Ans
- 1. (9, 106, 12)
  - 2. (8, 89, 17)
  - 3. (13, 62, 4)
  - 4. (7, 77, 11)

Q.7 What should come in place of the question mark (?) in the given series based on the English alphabetical order?  
LQO, MRP, NSQ, OTR, ?

- Ans
- 1. USP
  - 2. PSU
  - 3. PUS
  - 4. UPS

Q.8 What will come in the place of the question mark '?' in the following equation, if '+' and '-' are interchanged and 'x' and '÷' are interchanged?  
 $4 - 8 \div 12 + 16 \times 2 = ?$

- Ans
- 1. 92
  - 2. 94
  - 3. 90
  - 4. 86

Q.9 What should come in place of the question mark (?) in the given series based on the English alphabetical order?  
FXI, CUF, ZRC, WOZ, ?

- Ans
- 1. SOU
  - 2. SNV
  - 3. RMU
  - 4. TLW

Q.10 In the following number-pairs, the second number is obtained by applying certain mathematical operations to the first number. Select the set in which the numbers are related in the same way as are the numbers of the following sets.

(NOTE: Operations should be performed on the whole numbers, without breaking down the numbers into its constituent digits. E.g., 13 – Operations on 13 such as adding/subtracting/multiplying etc. to 13 can be performed. Breaking down 13 into 1 and 3 and then performing mathematical operations on 1 and 3 is not allowed.)

(36, 75)  
(42, 87)

- Ans
- 1. (36, 77)
  - 2. (48, 100)
  - 3. (45, 93)
  - 4. (47, 99)

Q.11 What will come in place of the question mark (?) in the following equation if '+' and '-' are interchanged and 'x' and '÷' are interchanged?

$$31 + 14 - 28 \times 7 \div 13 = ?$$

- Ans
- 1. 75
  - 2. 72
  - 3. 69
  - 4. 67

Q.12 Select the option figure that will replace the question mark (?) in the figure given below to complete the pattern.

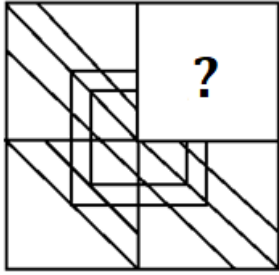

Ans

1.
2.
3.
4.



Q.13 In a certain code language, 'BORN' is coded as '6248' and 'NEST' is coded as '9873'.

What is the code for 'N' in the given code language?

- Ans
1.  7
  2.  8
  3.  2
  4.  9

Q.14 Select the word-pair that best represents a similar relationship to the one expressed in the pair of words given below.  
(The words must be considered as meaningful English words and must not be related to each other based on the number of letters/number of consonants/vowels in the word.)

Large : Big

- Ans
- 1. Same : Alike
  - 2. Far : Near
  - 3. First : Last
  - 4. Demolish : Repair

Q.15 AF 19 is related to CH 16 in a certain way. In the same way, GL 23 is related to IN 20. To which of the following is MR 36 related, following the same logic?

- Ans
- 1. NR 34
  - 2. OR 34
  - 3. NT 33
  - 4. OT 33

Q.16 What should come in place of the question mark (?) in the given series?  
96, 104, 112, ?, 128, 136

- Ans
- 1. 125
  - 2. 110
  - 3. 120
  - 4. 115



Q.17 Select the option in which the given figure is embedded (rotation is NOT allowed).

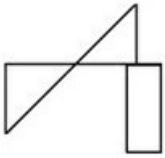

Ans

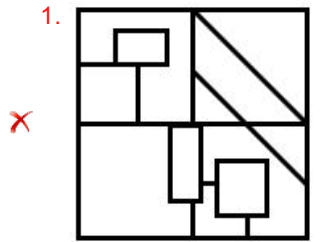

✗

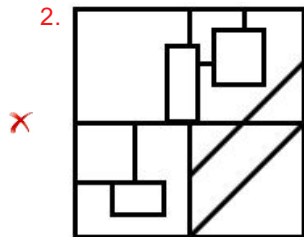

✗

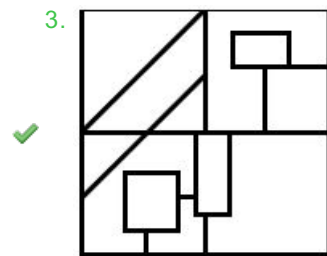

✓

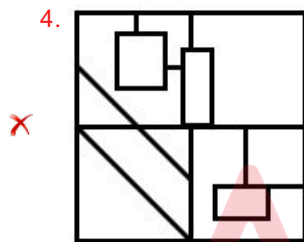

✗



Q.18 The position(s) of how many letters will remain unchanged if each of the letters in the word FORCING is arranged in the English alphabetical order?

Ans

- ✗ 1. Two
- ✓ 2. Zero
- ✗ 3. One
- ✗ 4. Three

Q.19 What should come in place of the question mark (?) in the given series based on the English alphabetical order?  
BFH, CGI, DHJ, EIK, ?

Ans

- ✓ 1. FJL
- ✗ 2. FIL
- ✗ 3. EJL
- ✗ 4. GKM

Q.20 Select the correct option that indicates the arrangement of the following words in a logical and meaningful order.

1. Rectangle
2. Hexagon
3. Nonagon
4. Triangle
5. Pentagon

Ans  1. 4, 1, 5, 2, 3  
 2. 5, 2, 3, 1, 4  
 3. 4, 2, 5, 1, 3  
 4. 3, 2, 1, 4, 5

Q.21 What should come in place of the question mark (?) in the given series based on the English alphabetical order?

BLF DJH FHJ HFL ?

Ans  1. GHU  
 2. TFY  
 3. JDY  
 4. JDN

Q.22 What should come in place of the question mark (?) in the given series based on the English alphabetical order?  
VWZ, BCF, HIL, NOR, TUX, ?

Ans  1. ZAC  
 2. ZAD  
 3. YBE  
 4. YBD

Q.23 What should come in place of '?' in the given series?  
743, 648, 553, 458, 363, ?

Ans  1. 275  
 2. 246  
 3. 253  
 4. 268

Q.24 5 is related to 67 following a certain logic. Following the same logic, 7 is related to 93. To which of the following is 11 related following the same logic?

(NOTE: Operations should be performed on the whole numbers, without breaking down the numbers into their constituent digits. E.g. 13 – Operations on 13 such as adding / subtracting / multiplying to 13 can be performed. Breaking down 13 into 1 and 3 and then performing mathematical operations on 1 and 3 is not allowed.)

Ans  1. 145  
 2. 144  
 3. 146  
 4. 148

Q.25 What should come in place of the question mark (?) in the given series based on the English alphabetical order?

ACKP, GIQV, MOWB, SUCH, ?

- Ans
- 1. YAIN
  - 2. YBIN
  - 3. YHJK
  - 4. YASD

Q.26 Santhosh starts from his home and drives 5 km towards the east. He then takes a right turn, drives 8 km, turns left, and drives 3 km. He then takes a right turn and drives 5 km and turns left, then drives 3 km to reach his office.

In which direction is the office with respect to his home?  
(All turns are 90° turns only, unless specified.)

- Ans
- 1. South-east
  - 2. North-east
  - 3. West
  - 4. North

Q.27 NRMJ is related to PTOL in a certain way based on the English alphabetical order. In the same way, QUPM is related to SWRO. To which of the following is TXSP related, following the same logic?

- Ans
- 1. VZUR
  - 2. VZRU
  - 3. ZVRU
  - 4. ZVUR

Q.28 In a group of five friends, each has a different age. Sony is younger than Ramesh. Mohan is younger than Chand. Only two people are older than Chand. Sita is younger than Mohan. Who is the second youngest in the group?

- Ans
- 1. Chand
  - 2. Sony
  - 3. Sita
  - 4. Mohan

Q.29 Which of the following numbers will replace the question mark (?) in the given series?  
225, 200, 183, 174, ?, 168

- Ans
- 1. 168
  - 2. 170
  - 3. 167
  - 4. 169



Q.30 Select the option figure in which the given figure is embedded as its part (rotation is NOT allowed).



Ans

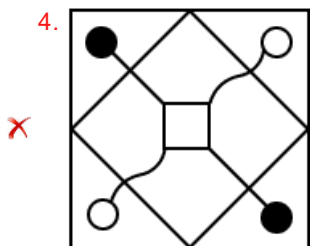
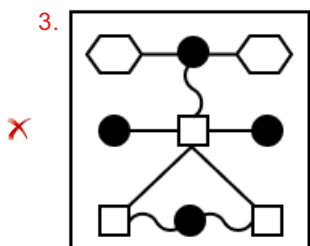
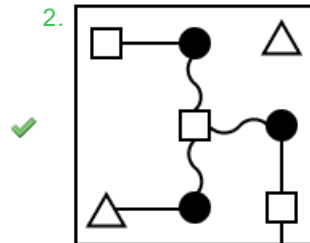
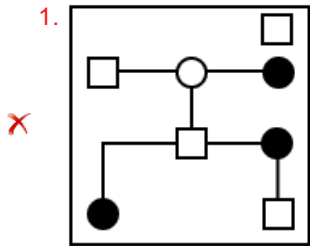

Q.31 In a certain code language, 'we are friends' is written as 'aj er kl' and 'friends are forever' is written as 'er aj pu'. How is 'forever' written in the given language?

Ans  1. pu

2. er

3. kl

4. aj

Q.32 Select the option in which the given figure is embedded (rotation is NOT allowed).

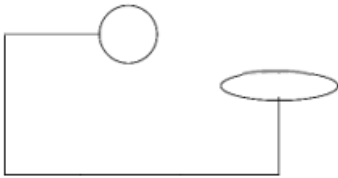

Ans

1.

✗

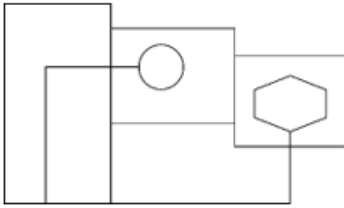

2.

✓

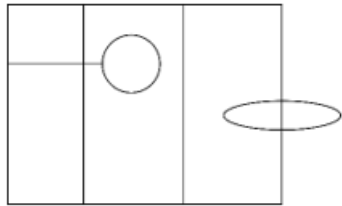

3.

✗

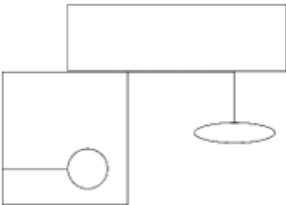

4.

✗

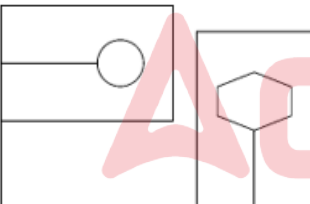

Q.33 If 'A' stands for '+', 'B' stands for '-', 'C' stands for 'x' and 'D' stands for '÷', what will be come in place of question mark (?) in the following equation?  
35 C 4 D 7 B 10 A 2 = ?

Ans

✗ 1. 8

✗ 2. 10

✗ 3. 13

✓ 4. 12

Q.34 Read the given statements and conclusions carefully. Assuming that the information given in the statements is true, even if it appears to be at variance with commonly known facts, decide which of the given conclusion(s) logically follow(s) from the statements.

Statement: Some ceilings are skies. Some skies are blue.

Conclusion 1: Some ceilings are blue.

Conclusion 2: Some skies are not blue.

- Ans
- 1. Only conclusion 2 follows
  - 2. Neither conclusion 1 nor 2 follows
  - 3. Both conclusion 1 and 2 follow
  - 4. Only conclusion 1 follows

Q.35 LMNB is related to PQRF in a certain way based on the English alphabetical order. In the same way, CDFH is related to GHJL. To which of the following is KTSO related, following the same logic?

- Ans
- 1. LKFR
  - 2. OXWS
  - 3. RTJH
  - 4. BMGH

Q.36 Select the word-pair that best represents a similar relationship to the one expressed in the pair of words given below. (The words must be considered as meaningful English words and must not be related to each other based on the number of letters/number of consonants/vowels in the word.)

Horse : Mare

- Ans
- 1. Drone : Duck
  - 2. Peacock : Vixen
  - 3. Buck : Doe
  - 4. Fox : Goose

Q.37 IK 3 is related to EO 7 in a certain way. In the same way, YO 5 is related to US 9. To which of the following is ZU 5 related, following the same logic?

- Ans
- 1. WV 7
  - 2. VW 7
  - 3. VY 9
  - 4. VX 9

Q.38 L, M, N, D, E, F and G are sitting around a circular table facing the center (not necessarily in the same order). Only three people sit between F and N when counted from the left of F. Only three people sit between L and E when counted from the left of L. Only three people sit between G and D when counted from the left of G. D sits to the immediate left of N. M is not an immediate neighbour of E. Who sits third to the right of M?

- Ans
- 1. E
  - 2. F
  - 3. D
  - 4. G

Q.39 What will come in the place of the question mark (?) in the following equation, if '+' and '-' are interchanged and 'x' and '÷' are interchanged?

$$82 + 52 \div 26 \times 13 - 4 = ?$$

- Ans
- 1. -68
  - 2. 9
  - 3. 36
  - 4. -18

Q.40 The position(s) of how many letters will remain unchanged if each of the letters in the word ACQUIRE is arranged in the English alphabetical order?

- Ans
- 1. Two
  - 2. One
  - 3. Zero
  - 4. Three

Q.41 Select the option in which the numbers share the same relationship as that shared by the given number triads.

2-8-32

5-20-80

(NOTE: Operations should be performed on the whole number, without breaking down the numbers into its constituent digits. E.g. 13- Operations on 13 such as adding/subtracting/multiplying etc. to 13 can be performed. Breaking down 13 into 1 and 3 and then performing mathematical operations on 1 and 3 is NOT allowed.)

- Ans
- 1. 1-4-12
  - 2. 4-8-12
  - 3. 5-25-100
  - 4. 3-12-48

Q.42 11 is related to 77 following a certain logic. Following the same logic, 16 is related to 112. To which of the following is 21 related, following the same logic?

(NOTE: Operations should be performed on the whole numbers, without breaking down the numbers into its constituent digits. E.g. 13 – Operations on 13 such as adding/subtracting/multiplying etc. to 13 can be performed. Breaking down 13 into 1 and 3 and then performing mathematical operations on 1 and 3 is not allowed.)

- Ans
- 1. 145
  - 2. 147
  - 3. 149
  - 4. 151

Q.43 A dice has its faces marked by numbers 4, 5, 6, 7, 8 and 9. Two positions of the same dice are shown below. Which of the given statements follows?

- I) The sum of face 9 and the face opposite to it is a multiple of 3.
- II) Face 8 has a prime number as its opposite face.

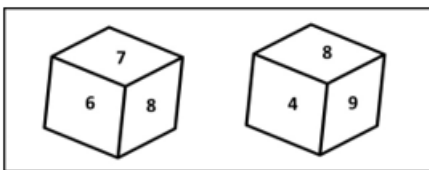

- Ans
- 1. Both statements I and II follow.
  - 2. Only statement I follows.
  - 3. Neither statement I nor II follows.
  - 4. Only statement II follows.

Q.44 YV15 is related to TQ13 in a certain way. In the same way, VS19 is related to QN17. To which of the following is XU13 related, following the same logic?

- Ans
- 1. ST13
  - 2. SP11
  - 3. RP11
  - 4. RP13

Q.45 PS 77 is related to UX 108 in a certain way. In the same way, RK 18 is related to WP 49 . To which of the following is BW 59 related, following the same logic?

- Ans
- 1. HC 88
  - 2. IB 87
  - 3. GA 89
  - 4. GB 90

Q.46 Read the given statements and conclusions carefully. You have to take the given statements to be true even if they seem to be at variance from commonly known facts. You have to decide which conclusion/s logically follow/s from the given statements.

Statements: All kites are rocks. All rocks are lakes. All lakes are planets.

Conclusions:

(I) All rocks are planets.

(II) At least some lakes are kites.

- Ans
- 1. Only conclusion (I) follows.
  - 2. Both conclusions (I) and (II) follow.
  - 3. Only conclusion (II) follows.
  - 4. Neither conclusion (I) nor (II) follows.

Q.47 In a certain code language, 'DEFAULT' is coded as 'DTLUAFE' and 'BROUGHT' is coded as 'BTHGUOR'. What is the code for 'FANTASY' in the given language?

- Ans
- 1. FYSATNA
  - 2. YSATNAF
  - 3. SATANF
  - 4. YFANTAS

Q.48 In a certain code language,  
'A + B' means 'A is the mother of B',  
'A - B' means 'A is the brother of B',  
'A × B' means 'A is the sister of B', and  
'A ÷ B' means 'A is the husband of B'.  
How is L related to R if 'N - S ÷ L × M + Q - R'?

- Ans
- 1. Mother's mother
  - 2. Mother
  - 3. Father's sister
  - 4. Mother's sister

Q.49 Kirti starts from point A and walks 1 km towards east. She takes a right turn and walks 2 km. She then takes a left turn and walks 3 km. She takes a right turn and walks 4 km. She takes a left turn and walks 5 km. She takes a final left turn and walks 6 km to reach a point B. How far (shortest distance) and towards which direction should she walk in order to reach point A again? (All turns are 90 degree turns only unless specified otherwise.)

- Ans
- 1. 9 km west
  - 2. 8 km west
  - 3. 6 km west
  - 4. 7 km west

Q.50 A, B, C, D, P, Q, and R are sitting around a circular table, facing the centre (not necessarily in the same order). Only D sits between B and C when counted from the left of B. P sits fourth to the right of D. R is an immediate neighbour of both P and C. Q is not an immediate neighbour of P. How many people are sitting between D and A when counted from the left of A?

- Ans
- 1. One
  - 2. Two
  - 3. Four
  - 4. Three

Section : General Awareness

Q.1 Which phylum includes organisms with radial symmetry, such as sea anemones and jellyfish?

- Ans
- 1. Cnidaria
  - 2. Platyhelminthes
  - 3. Mollusca
  - 4. Porifera

Q.2 Which of the following statements is true?

- A. Igneous rocks are used as fuel by igniting them.
- B. Sedimentary rocks can never change into metamorphic rocks or magma.
- C. Igneous rocks can change into sedimentary rocks over a long period of time.
- D. Magma can form sedimentary rocks on cooling.

- Ans
- 1. D
  - 2. C
  - 3. B
  - 4. A

Q.3 Where was the Paramhans Mandali formed in the year 1840 to eradicate the Caste System?

- Ans
- 1. Murshidabad
  - 2. Bombay
  - 3. Calcutta
  - 4. Delhi

Q.4 Identify whether the following statements are true (T) or false (F) and select the correct option.

- A. On solidification, molten magma forms sedimentary rocks.
- B. Igneous rocks can be intrusive or extrusive.
- C. Under the effect of high temperatures and pressure, sedimentary rocks change to metamorphic rocks.
- D. Under the effect of high temperatures and pressure, igneous rocks change to metamorphic rocks.

- Ans
- 1. FTTT
  - 2. TTTF
  - 3. TFFF
  - 4. TTFF

Q.5 What is the acceleration due to gravity on the surface of the Earth?

- Ans
- 1. 12.5 m/s<sup>2</sup>
  - 2. 9.8 m/s<sup>2</sup>
  - 3. 6.2 m/s<sup>2</sup>
  - 4. 3.0 m/s<sup>2</sup>

Q.6 When was the 'Vivad se Vishwas II (Contractual Disputes)' scheme announced by the Union Finance Minister?

- Ans
- 1. Union Budget 2020-21
  - 2. Union Budget 2021-22
  - 3. Union Budget 2022-23
  - 4. Union Budget 2023-24

Q.7 Which of the following states initiated Mukhyamantri Digital Seva Yojana for women empowerment through increasing digital reach of women by providing 3 years internet services (data) along with smart phones in 2022?

- Ans
- 1. Kerala
  - 2. Himachal Pradesh
  - 3. Andhra Pradesh
  - 4. Rajasthan

Q.8 What is the keyboard shortcut to edit the contents of a cell in Microsoft Excel?

- Ans
- 1. F2
  - 2. Alt + E
  - 3. Shift + Enter
  - 4. Ctrl + S

Q.9 The Parsi reform movement Rahnumai Mazdayasna Sabha was founded in which year?

- Ans
- 1. 1841
  - 2. 1851
  - 3. 1855
  - 4. 1849

Q.10 According to Census of India 2011, what is the percentage of Hindu population in India?

- Ans
- 1. 79.8%
  - 2. 84.1%
  - 3. 75.6%
  - 4. 72.7%

Q.11 Besides the cell organelles, there are various types of non-living components within a cell, which are known as:

- Ans
- 1. Cytoplasmic Inclusion
  - 2. Plasmodesmata
  - 3. Tubules
  - 4. Microfibrils

Q.12 Who sworn in as a member of the Union Public Service Commission in September 2023?

- Ans
- 1. Suman Sharma
  - 2. Dinesh Dasa
  - 3. Preeti Sudan
  - 4. Bidyut Behari Swain

Q.13 Who was the first Sultan of the Sultanate period who arranged for the translation of Hindu scriptures from Sanskrit to Persian?

- Ans
- 1. Sikandar Khan Lodi
  - 2. Firoz Shah Tughlaq
  - 3. Muhammad bin Tughluq
  - 4. Alauddin Khilji

Q.14 The type of carbohydrate predominantly found in potatoes is \_\_\_\_\_.

- Ans
- 1. Sugar
  - 2. Glucose
  - 3. Starch
  - 4. Fructose

Q.15 Which government agency released the draft Registration of Consumer Organisations (Amendment) Regulations on 14 September 2023?

- Ans
- 1. Telecom Regulatory Authority of India (TRAI)
  - 2. Insurance Regulatory and Development Authority of India (IRDAI)
  - 3. Advertising Standards Council of India (ASCI)
  - 4. Securities and Exchange Board of India (SEBI)

Q.16 The Registration of Births and Deaths (Amendment) Bill 2023 aims to make the \_\_\_\_\_ only conclusive age proof that can be used as a single document for various purposes.

- Ans
- 1. ST/SC/OBC Certificate
  - 2. Birth Certificate
  - 3. Voter ID
  - 4. Aadhar Card

Q.17 Who can appoint the judges of the High Court?

- Ans
- 1. Prime Minister
  - 2. President
  - 3. Attorney General
  - 4. Governor

Q.18 In the ecosystem, there can be multiple food chains, but only a limited number of trophic levels. Based on this statement which of the following is NOT true?

- A: Each level in the food chain represents one trophic level
- B: Organisms in the lowest trophic level have the highest population as a lot of energy is available for their survival
- C: There is a loss of energy as it is being absorbed by organisms at the higher trophic level
- D: Organisms at the highest trophic level make their own food and do not fully depend on the lower trophic organisms for energy.

- Ans
- 1. A
  - 2. B
  - 3. C
  - 4. D

Q.19 In which of the following Indian States was the 50<sup>th</sup> All India Inter-Institutional Table Tennis Championships organised in 2023?

- Ans
- 1. Kerala
  - 2. Karnataka
  - 3. Andhra Pradesh
  - 4. Haryana



Q.20 In which year was the Swaran Singh Committee set up by the Indira Gandhi Government?

- Ans
- 1. 1976
  - 2. 1978
  - 3. 1972
  - 4. 1974

Q.21 The National Lata Mangeshkar Award 2021 was given to:

- Ans
- 1. Arijit Singh
  - 2. Udit Narayan
  - 3. Sonu Nigam
  - 4. Kumar Sanu

Q.22 Which Article of the Constitution of India grants citizens the right to freedom of speech and expression, freedom of assembly and freedom to practice any profession?

- Ans
- 1. Article 17
  - 2. Article 18
  - 3. Article 19
  - 4. Article 25

Q.23 Which of the following is the most important disease related to Vitamin C deficiency?

- Ans
- 1. Pellagra
  - 2. Atherosclerosis
  - 3. Scurvy
  - 4. Goitre

Q.24 The excess cadmium accumulation in our body, damages which part of the body?

- Ans
- 1. Hands and feet
  - 2. Eye
  - 3. Stomach
  - 4. Liver and kidneys

Q.25 As of July 2023, who is the Chief Minister of Karnataka?

- Ans
- 1. BS Yedurappa
  - 2. Jagadish Shettar
  - 3. Siddaramaiah
  - 4. Basavaraj Bommai

Q.26 In which state is the Bhitarkanika National Park located?

- Ans
- 1. Tamil Nadu
  - 2. Odisha
  - 3. Jharkhand
  - 4. Manipur

Q.27 What is the height of Mahendragiri which is the highest peak in the Eastern Ghats?

- Ans
- 1. 1150 meters
  - 2. 1510 meters
  - 3. 1051 meters
  - 4. 1501 meters

Q.28 Which of the following is an example of a terrestrial biome?

- Ans
- 1. Estuary
  - 2. Kelp forest
  - 3. Coral reef
  - 4. Taiga

Q.29 Pandit Kumar Gandharva received the \_\_\_\_\_ in 1977 for his contributions in the field of Hindustani Classical music.

- Ans
- 1. Padma Bhushan
  - 2. Padma Shri
  - 3. Tansen Samman
  - 4. Karnataka Ratna

Q.30 What is the chemical reaction that occurs when fats or oils combine with a strong alkali, such as sodium hydroxide, to make soap?

- Ans
- 1. Saponification
  - 2. Combustion
  - 3. Fermentation
  - 4. Oxidation

Q.31 What is the purpose of the geo-portal 'Greening and Restoration of Wastelands with Agroforestry (GROW)' developed by NITI Aayog?

- Ans
- 1. Promoting agro-based industries
  - 2. Identifying suitable areas for agroforestry interventions
  - 3. Tracking wildlife migration
  - 4. Monitoring urban agriculture development projects

Q.32 Choose the correct statement/s from the following.

- i. It is difficult to carry one's wealth under a barter system of transactions.
- ii. Money is perishable and it cannot be stored.
- iii. An increase in the price level can diminish the purchasing power of currency.

- Ans
- 1. i and iii
  - 2. ii and iii
  - 3. i and ii
  - 4. Only ii

Q.33 Which of the following are the requisite qualifications of Supreme Court judges?

- 1) He should be a citizen of India.
- 2) He should have been a High Court judge for five years or should have been a High Court advocate for ten years.
- 3) He should be a distinguished jurist in the opinion of the President.
- 4) He should be a minimum of 35 years old.

- Ans
- 1. Only 1, 3 and 4
  - 2. Only 1, 2 and 3
  - 3. Only 1, 2 and 4
  - 4. Only 2, 3 and 4

**Q.34 What did the Right of Children to Free and Compulsory Education Act 2009 in India lay down?**

- Ans
- 1. Legal underpinnings for achieving universal higher education
  - 2. Legal underpinnings for achieving vocational education
  - 3. Legal underpinnings for achieving universal elementary education
  - 4. Legal underpinnings for achieving quality and excellence in education

**Q.35 The primary function of which globular structure is to produce and assemble the ribosomes of the cell?**

- Ans
- 1. Chromatin
  - 2. Nucleolus
  - 3. Centriole
  - 4. Peroxisomes

**Q.36 Meera shifted to a new house and was fixing light bulbs in her apartment. One of the three bulbs she fixed did not light up. Upon testing she realised it was a case of fused bulb. So, she bought a new one which then lit up perfectly. Select the correct option that describes what happened to the fused bulb.**

- Ans
- 1. The switch for the bulb was not turned on
  - 2. Meera did not fix the bulb to the holder properly
  - 3. The filament inside it was broken
  - 4. There was no connection between the bulb holder and the switch

**Q.37 Which chief minister launched the process of distributing 'Orunodoi Cards' to new beneficiaries in October 2023?**

- Ans
- 1. YS Jagan Mohan Reddy
  - 2. Neiphiu Rio
  - 3. Pinarayi Vijayan
  - 4. Himanta Biswa Sarma

**Q.38 Which sport is Leander Paes associated with?**

- Ans
- 1. Table Tennis
  - 2. Tennis
  - 3. Badminton
  - 4. Squash

**Q.39 Which institution was formed on 2 April 1990?**

- Ans
- 1. SIDBI
  - 2. EXIM Bank
  - 3. NHB
  - 4. IRBI

**Q.40 Brine water is saturated or strongly impregnated with which of the following ionic compounds?**

- Ans
- 1. Sodium hydroxide
  - 2. Sodium bromide
  - 3. Sodium chloride
  - 4. Sodium iodide

Q.41 Which river has its source in the Western Ghats range of Karnataka state?

- Ans
- 1. Banas
  - 2. Sarayu
  - 3. Kosi
  - 4. Kaveri

Q.42 What does the 'Print Range' option allow you to specify while printing a document?

- Ans
- 1. Number of copies to print
  - 2. Specific area or range of pages to print
  - 3. Paper size and type
  - 4. Printer settings

Q.43 Which of the following organisations was established in 1906?

- Ans
- 1. Akhil Bharat Hindu Mahasabha
  - 2. All India Muslim League
  - 3. Servants of India Society
  - 4. Parsi Religious Reform Association

Q.44 According to Census of India 2011, India's population accounts for \_\_\_\_\_ of the world's population.

- Ans
- 1. 15.5%
  - 2. 17.5%
  - 3. 19.3%
  - 4. 21.7%

Q.45 Which element is a transition metal in Group 9 of the periodic table?

- Ans
- 1. Iron (Fe)
  - 2. Copper (Cu)
  - 3. Nickel (Ni)
  - 4. Cobalt (Co)

Q.46 According to Agricultural Statistics at a Glance 2022, Government of India, which state produced 44.48% groundnut of India during the year 2021-2022?

- Ans
- 1. Rajasthan
  - 2. Tamil Nadu
  - 3. Maharashtra
  - 4. Gujarat

Q.47 Which of the following Articles of the Indian Constitution is related to the Directive Principles of State Policy?

- Ans
- 1. Articles 11-50
  - 2. Articles 25-55
  - 3. Articles 36-51
  - 4. Articles 50-101

Q.48 In which year did Rudolf Virchow develop his ideas by publishing his famous formula 'Omnis cellula-e cellula', which became a part of the foundation of cell theory?

- Ans
- 1. 1830
  - 2. 1855
  - 3. 1890
  - 4. 1902

Q.49 What is  $u$  in the equation  $s = ut + \frac{1}{2} at^2$ , which represents the position-time relation?

- Ans
- 1. Uniform acceleration
  - 2. Initial velocity
  - 3. Speed of the object
  - 4. Change in momentum

Q.50 What is the most common factor for the yellowing of the Taj Mahal gradually over the years?

- Ans
- 1. Acid rain
  - 2. Carbon monoxide present in air
  - 3. Marble turns yellow with time
  - 4. Marble reacts with nitrogen in air

Section : General Engineering Civil and Structural

Q.1 Which of the following is NOT a warning sign?

- i. Pedestrian Crossing
- ii. Men at Work
- iii. School
- iv. Truck Prohibited
- v. No stopping

- Ans
- 1. Both iv and v
  - 2. Both i and iv
  - 3. Both ii and iii
  - 4. Both ii and v

Q.2 As per India Road Congress, what is the carriage way width of a single lane road with raised kerbs?

- Ans
- 1. 2 m
  - 2. 3 m
  - 3. 3.75 m
  - 4. 2.5 m

Q.3 In a hydraulic jump occurring in a horizontal rectangular channel, the sequent depths are 0.25 m and 1.25 m. The energy loss in this jump is:

- Ans
- 1. 1 m
  - 2. 1.5 m
  - 3. 0.80 m
  - 4. 1.25 m

Q.4 A compound pipeline consists of two pieces of identical pipes. The equivalent length of the same diameter and the same friction factor for this compound pipeline is  $L_1$  when the pipes are connected in series and is  $L_2$  when the pipes are connected in parallel. Determine the ratio of equivalent lengths, that is,  $L_1$  to  $L_2$ .

- Ans
- 1. 64 : 1
  - 2. 4 : 1
  - 3. 32 : 1
  - 4. 8 : 1

Q.5 A slab is classified as a one-way slab if \_\_\_\_\_.

Where

$L_y$  = larger dimension of the slab

$L_x$  = Shorter dimension of the slab

Ans

✓ 1.  $\frac{L_y}{L_x} > 2$

✗ 2.  $\frac{L_x}{L_y} > 2$

✗ 3.  $\frac{L_x}{L_y} < 2$

✗ 4.  $\frac{L_y}{L_x} < 2$

Q.6 As per IS 10262 : 2019, what is the approximate amount of entrapped air to be expected in normal (non-air-entrained) concrete, when 10 mm Nominal Maximum Size of Aggregate is used in making concrete?

Ans

✓ 1. 1.5

✗ 2. 1.0

✗ 3. 0.5

✗ 4. 2.0

Q.7 A material has linear strains along X, Y and Z directions as 0.05, 0.10 and 0.10, respectively. Hydrostatic stress acting at a point in the material is 25 N/mm<sup>2</sup>. Calculate the bulk modulus.

Ans

✗ 1. 250 N/mm<sup>2</sup>

✗ 2. 500 N/mm<sup>2</sup>

✓ 3. 100 N/mm<sup>2</sup>

✗ 4. 125 N/mm<sup>2</sup>

Q.8 Which of the following tests is commonly used to measure the softening point of bitumen?

Ans

✗ 1. Penetration test

✗ 2. Ductility test

✓ 3. Ring and ball test

✗ 4. Flash point test

Q.9 What are the two types of energy recovery processes?

Ans

✓ 1. Combustion and pyrolysis

✗ 2. Exothermic process and combustion

✗ 3. Exothermic process and pyrolysis

✗ 4. Endothermic process and pyrolysis

Q.10 Which of the following hydrocarbons has the lowest carbon content?

Ans

✗ 1. Tar

✗ 2. Asphalt

✗ 3. Bitumen

✓ 4. Methane

Q.11 What is the chemical combination formula of Plaster of Paris?

- Ans
- 1.  $\text{CaSO}_3 \cdot 2\text{H}_2\text{O}$
  - 2.  $\text{CaSO}_4 \cdot \frac{1}{2}\text{H}_2\text{O}$
  - 3.  $\text{CaSO}_4 \cdot 2\text{H}_2\text{O}$
  - 4.  $\text{CaCO}_3 \cdot 2\text{H}_2\text{O}$

Q.12 As per the Environment Protection Act, 1986, what are the permitted noise limits (in decibel) for the silence zone during day time and night time?

- Ans
- 1. 60 and 50, respectively
  - 2. 50 and 60, respectively
  - 3. 50 and 40, respectively
  - 4. 40 and 30, respectively

Q.13 In the case of Atterberg limits of a soil, the shrinkage index of the soil will be equal to :

- Ans
- 1. the difference between the liquid limit and shrinkage limit
  - 2. the sum of shrinkage ratio and flow index
  - 3. the difference between the plastic limit and shrinkage limit
  - 4. the difference between the liquid limit and plastic limit

Q.14 In the estimation of minimum radius of horizontal circular curve on non-urban highways following IRC : 73 - 1980, using the equation  $R = v^2 / (g(e + f))$ , the notation 'f' represents \_\_\_\_\_.

- Ans
- 1. Width of roadway
  - 2. Vehicle speed
  - 3. Superelevation ratio
  - 4. Co-efficient of side friction between vehicle tyres and pavement

Q.15 How does the age of concrete affect its compressive strength?, consider the age limit as 28 days with continued curing.

- Ans
- 1. Age of concrete doesnot affect the compressive strength of concrete
  - 2. Compressive strength increases as the age of concrete increases
  - 3. Compressive strength decreases upto an age 7 days and continues to decrease on further curing
  - 4. Compressive strength increases upto an age 14 days and continues to decrease on further curing

Q.16 For a semicircular plate of diameter 'D' and radius 'R', with 'y' as the vertical axis passing through the diameter and 'x' as the horizontal axis passing through the diameter, the moment of inertia about the y axis will be:

- Ans
- 1.  $0.10976 R^3$
  - 2.  $\frac{\pi D^4}{128}$
  - 3.  $0.10976 R^4$
  - 4.  $\frac{\pi D^4}{16}$

Q.17 Which of the following statements is true regarding the compensator used in an electronic theodolite?

- Ans
- 1. It compensates for the effect of tilt of the axis of the bubble tube.
  - 2. It compensates for the effect of vertical axis tilt.
  - 3. It compensates for the effect of horizontal axis tilt.
  - 4. It compensates for the effect of tilt of the line of sight.

Q.18 If the velocity of flow of water through the soil is 0.01 cm/s and the piezometer readings at the end points A and B of soil sample are 10 cm and 5 cm, respectively. The distance between the points A and B is 20 cm. Find the coefficient of permeability of the soil sample.

- Ans
- 1. 0.25 cm/s
  - 2. 0.04 cm/s
  - 3. 0.025 cm/s
  - 4. 4 cm/s

Q.19 In a sieve analysis of soil, the total weight of soil taken was 500 g. The mass of soil retained over 4.75 mm sieve was 100 g, mass retained over 2 mm sieve was 150 g, and the mass retained over 425-micron sieve was 200 g. The effective size of the soil will be:

- Ans
- 1. 75 microns
  - 2. 425 microns
  - 3. 4.75 mm
  - 4. 2 mm

Q.20 An abstract of estimated cost is prepared after obtaining the cost of each individual item of work and then adding them all together. This estimated cost is increased by 5% to account for any unforeseen expenses, which are referred to as:

- Ans
- 1. work charged establishment
  - 2. departmental charges
  - 3. contingencies
  - 4. overhead charges

Q.21 In regard to the resection method of plane table survey, the term 'resector' refers to the \_\_\_\_\_.

- Ans
- 1. rays drawn from the known location of the station to the un-plotted location of the points
  - 2. rays drawn from the un-plotted location of the station to the known location of the points
  - 3. rays drawn from the un-plotted location of the station to the un-plotted location of the points
  - 4. rays drawn from the known location of the station to the known location of the points

Q.22 The fineness of a cement sample is determined by using \_\_\_\_\_ method.

- Ans
- 1. Blaine's air permeability
  - 2. Le Chatelier
  - 3. slump cone
  - 4. universal testing

Q.23 Which of the given condition is ensured in RC members due to the proper bond between reinforcing steel and surrounding concrete?

- Ans
- 1. Force compatibility
  - 2. Bending compatibility
  - 3. Stress compatibility
  - 4. Strain compatibility

Q.24 If the water table reaches the ground level, the unit weight of soil for bearing capacity calculation is taken as:

- Ans
- 1. bulk unit weight
  - 2. saturated unit weight
  - 3. submerged unit weight
  - 4. dry unit weight



Q.25 For an irrigation project, Culturable Command area (CCA) =

- Ans
- 1. Culturable Command Area (CCA) = Gross Command Area (GCA)
  - 2. Culturable Command Area (CCA) = Gross Command Area (GCA) + Unculturable area
  - 3. Culturable Command Area (CCA) = Gross Command Area (GCA) - Unculturable area
  - 4. Culturable Command Area (CCA) = Unculturable area - Gross Command Area (GCA)

Q.26 In a soil's three-phase diagram, the constituents of soil are:

- Ans
- 1. segregated in three parts
  - 2. mixed together
  - 3. segregated in four parts
  - 4. segregated in two parts

Q.27 Which of the following statements about the circular sewer section is INCORRECT?

- Ans
- 1. It offers the maximum cross-sectional area for the amount of materials used in walls.
  - 2. Under the full-flow condition, a circular sewer has the maximum hydraulic radius.
  - 3. Circular sewers are easy to construct.
  - 4. It has low structural stability.

Q.28 According to the Mohr-Coulomb failure criterion in soils, which of the following statements are INCORRECT?

A: Shear strength is attributable to the interlocking of soil particles and cohesion.

B: Shear strength is only attributable to the internal friction between particles.

C: The Y-intercept represents friction of soils.

D: The Mohr-coulomb failure envelope is a straight line.

- Ans
- 1. B and D
  - 2. B and C
  - 3. A and D
  - 4. A and C

Q.29 In a circular tube of diameter 100 mm and length 15 m with laminar flow, the Darcy friction factor is estimated to be 0.05. Calculate the Reynolds number.

- Ans
- 1. 2500
  - 2. 1000
  - 3. 1280
  - 4. 900

Q.30 In plywood, three or more veneers in odd numbers are placed one above the other with the direction of grains of successive layers at \_\_\_\_\_ to each other.

- Ans
- 1. 30°
  - 2. 90°
  - 3. 60°
  - 4. 45°

Q.31 What is the function of a non-return valve?

- Ans
- 1. Blocks the flow of fluid in all directions in a pipe flow system
  - 2. Allows flow of liquid in a direction opposite to the pumping direction of liquid
  - 3. Allow the flow of liquid in one direction and prevents it from flowing back in opposite direction in a pipe flow system
  - 4. Allow the flow of liquid in both upward and downward direction in a pipe flow system

Q.32 As per IS 3129-1985, the permissible tolerance for the length of finished boards shall be \_\_\_\_\_.

- Ans
- 1.  $\pm 2$  mm
  - 2.  $\pm 8$  mm
  - 3.  $\pm 4$  mm
  - 4.  $\pm 6$  mm

Q.33 Which of the following estimate in done to account the costs required to keep the built structure in working and safe condition?

- Ans
- 1. Complete estimate
  - 2. Repair and maintenance estimate
  - 3. Quantity estimate
  - 4. Revised estimate

Q.34 Which of the following is used as a finishing coat for surfaces of X-ray rooms?

- Ans
- 1. Barium plaster
  - 2. Snowcrete
  - 3. Colocrete
  - 4. Parian cement

Q.35 Which of the following reinforced concrete structure is commonly used to keep the earth in vertical and stable position at locations where the ground level changes abruptly?

- Ans
- 1. Slab
  - 2. Beam
  - 3. Retaining wall
  - 4. Column

Q.36 Select the option that is appropriate regarding the following two statements labelled Assertion and Reason.  
Assertion: The volume of water stored in a reservoir between the normal pool level and the maximum pool level is known as surcharge storage.  
Reason: Surcharge storage is mainly to detain the flood water so that it does not cause any danger on the downstream side.

- Ans
- 1. Both Assertion and Reason are false.
  - 2. Both Assertion and Reason are true and Reason is the correct explanation of Assertion.
  - 3. Assertion is true, but Reason is false.
  - 4. Both Assertion and Reason are true, but Reason is not the correct explanation of Assertion.

Q.37 Identify the INCORRECT statement with respect to specifications on the partial safety factors for material strength, and are used in limit state design of RC structures

- Ans
- ✓ 1. A partial safety factor '1.15' is used for steel under serviceability limit state
  - ✗ 2. A higher partial safety factor has been assigned to concrete compared with reinforcing steel under the ultimate limit state.
  - ✗ 3. A partial safety factor 1.5 is used for concrete under ultimate limit state
  - ✗ 4. A partial safety factor '1' is used for concrete under serviceability limit state

Q.38 In case of unavailability of space for providing development length in an RCC beam which option shall NOT be used to satisfy the criteria of development length?

- Ans
- ✗ 1. Bends
  - ✗ 2. Mechanical anchorages
  - ✗ 3. Hooks
  - ✓ 4. Chairs

Q.39 Identify the correct relationship for annual sinking fund.

Where,

I = Annual sinking fund,

S = Total amount of sinking fund invested on that

i = Rate of interest

n = number of years required to get 'S'

- Ans
- ✓ 1. Sinking fund (I) =  $\frac{Si}{(1+i)^n - 1}$
  - ✗ 2. Sinking fund (I) =  $\frac{ni}{(1+n)^s - 1}$
  - ✗ 3. Sinking fund (I) =  $\frac{Si}{(1+n)^i - 1}$
  - ✗ 4. Sinking fund (I) =  $\frac{ni}{(1+s)^n - 1}$

Q.40 What is the major function of a water distribution system?

- Ans
- ✗ 1. To carry water from the source to the filtration unit
  - ✗ 2. To carry water from the source to the pump house
  - ✓ 3. To carry water from the treatment plant to individual homes
  - ✗ 4. To carry water from individual homes to the treatment plant

Q.41 Select the option that is appropriate regarding the following two statements labelled Assertion and Reason.

Assertion: In lined canals, the increased velocity eliminates the possibility of silting in the canal bed.

Reason: Canal lining provides a smooth and stable surface and thus, the velocity of the flow can be increased.

- Ans
- ✓ 1. Both Assertion and Reason are true and Reason is the correct explanation of Assertion.
  - ✗ 2. Both Assertion and Reason are true, but Reason is not the correct explanation of Assertion.
  - ✗ 3. Assertion is true, but Reason is false.
  - ✗ 4. Both Assertion and Reason are false.

Q.42 Which of the given options represents a doubly reinforced beam?

- Ans  1. A least Single layer of reinforcement in both tension and compression face  
 2. Two layers of reinforcement in only tension face  
 3. Single layer of reinforcement in only compression face  
 4. Double layer of reinforcement in only compression face

Q.43 Estimate the quantity of plastering required to plaster both the face of a wall of 5 m long, 4m high and 30 cm thickness, Ignore thickness faces of wall

- Ans  1. 20 sq. m  
 2. 24 sq. m  
 3. 40 sq. m  
 4. 50 sq. m

Q.44 A diamond intersection on the road is a type of:

- Ans  1. T intersection  
 2. Grade separated intersection  
 3. At grade intersection  
 4. Four way stop

Q.45 The integration constant C1 used in Macaulay's method of analysis is obtained by applying \_\_\_\_\_ to the integrated(1st integral) differential equation of given beam elastic curve.

- Ans  1. Partial Factor of safety  
 2. boundary condition for deflection  
 3. boundary condition for slope  
 4. Load factor

Q.46 Sodium clay can be used in the core of earthen dams because it has \_\_\_\_\_.

- Ans  1. low permeability  
 2. high permeability  
 3. low porosity  
 4. high strength

Q.47 Calculate the net area of the tension member consists a drilled hole of diameter 22 mm to place a M20 bolt. Take thickness of the tension member as 10 mm and gross area 1000 mm<sup>2</sup>.

- Ans  1. 550 mm<sup>2</sup>  
 2. 1000 mm<sup>2</sup>  
 3. 780 mm<sup>2</sup>  
 4. 680 mm<sup>2</sup>

Q.48 Following are the data of an externally focusing telescope used for a tacheometric survey.

Staff intercept	1.52 m
Interval between stadia hair	5 mm
Distance between the vertical axis of the telescope and the objective	120 mm
Focal length of the objective	0.3 m

The value of the multiplying constant is \_\_\_\_\_.

- Ans
- 1. 60
  - 2. 24
  - 3. 2.5
  - 4. 12.67

Q.49 The process that uses reclamation of saline soil, in which agricultural land is flooded with water to a depth of about 20-30 cm, is known as \_\_\_\_\_.

- Ans
- 1. surface drainage
  - 2. leaching
  - 3. washing
  - 4. sub-surface drainage

Q.50 Which process of cement manufacturing is commonly used in modern cement plants?

- Ans
- 1. Dry or wet process based on structural element the cement is used for
  - 2. Dry process
  - 3. Dry or wet process based on setting time requirement of cement
  - 4. Wet process

Q.51 Select the option that is appropriate regarding the following two statements labelled Assertion and Reason.  
Assertion: The main disadvantage of drip irrigation is requirement for a high initial investment.  
Reason: Drip irrigation requires regular flushing and supervision.

- Ans
- 1. Both Assertion and Reason are false.
  - 2. Both Assertion and Reason are true, but Reason is not the correct explanation of Assertion.
  - 3. Assertion is true, but Reason is false.
  - 4. Both Assertion and Reason are true and Reason is the correct explanation of Assertion.

Q.52 Select the option that is appropriate regarding the following two statements labelled Assertion and Reason.  
Assertion: Due to the inherent nature of various parameters involved in the process, the yield from a catchment is a random variable.  
Reason: The yield from a catchment is the end-product of various processes such as precipitation, infiltration and evapotranspiration operating on the catchment.

- Ans
- 1. Assertion is true, but Reason is false.
  - 2. Both Assertion and Reason are true and Reason is the correct explanation of Assertion.
  - 3. Both Assertion and Reason are true, but Reason is not the correct explanation of Assertion.
  - 4. Both Assertion and Reason are false.

Q.53 Which property of borosilicate glass makes it suitable for thermal shock resistance ?

- Ans
- 1. Low density
  - 2. High refractive index
  - 3. Low thermal expansion coefficient.
  - 4. High transparency

Q.54 Match the following flood control works with their functions.

Flood Control Work	Function
A. Check dams	1. To protect surrounding areas of a river from floods
B. Terrace bunds	2. To reduce the runoff velocity in stream channels.
C. Levees	3. To arrest sediments and the surface runoff in agricultural lands.

- Ans
- 1. A-1, B-3, C-2
  - 2. A-2, B-1, C-3
  - 3. A-2, B-3, C-1
  - 4. A-1, B-2, C-3

Q.55 Which of the following is NOT a source of noise pollution?

- Ans
- 1. Soft music
  - 2. Aircraft sounds
  - 3. Traffic noise
  - 4. Noise from industrial areas

Q.56 Calculate the slenderness ratio and classify the column type in accordance with IS 456 : 2000, if the diameter of column is 300 mm and effective length 3m.

- Ans
- 1. 13; long column
  - 2. 15; short column
  - 3. 8; long column
  - 4. 10; short column

Q.57 Which of the following statements is INCORRECT?

- Ans
- 1. Sound level  $L = \log_{10} \frac{Q}{Q_0}$  Bels  
Where Q = sound intensity,  $Q_0$  = reference sound intensity
  - 2. The sound pressure is expressed on a logarithmic scale.
  - 3. Measurements of the sound pressure on logarithmic scales are called levels.
  - 4. The sound pressure of the faintest fastest sound that can be heard by a normal healthy individual is about 10 micropascals.

Q.58 In which type of seasoning is timber immersed in a solution of suitable salt, and then taken out and seasoned in ordinary way?

- Ans
- 1. Kiln seasoning
  - 2. Chemical seasoning
  - 3. Water seasoning
  - 4. Boiling

Q.59 In levelling, \_\_\_\_\_ is also called minus sight.

- Ans
- 1. fore sight
  - 2. back sight
  - 3. Inverted intermediate sight
  - 4. intermediate sight

Q.60 According to the Newton's law of viscosity, the shear stress of a fluid element layer is directly proportional to the \_\_\_\_\_.

- Ans
- 1. pressure
  - 2. rate of shear strain
  - 3. bulk modulus
  - 4. elastic modulus

Q.61 For a linearly elastic, homogeneous, and isotropic material having modulus of rigidity-  $G$  and modulus of elasticity-  $E$ , the range of  $G$  is given as \_\_\_\_\_.

- Ans
- 1.  $\frac{E}{2}$  to  $\frac{E}{4}$
  - 2.  $\frac{E}{3}$  to  $\frac{E}{2}$
  - 3. 0 to  $\frac{E}{2}$
  - 4. 0 to  $\frac{E}{3}$

Q.62 A 15 cm diameter orifice discharging from a tank issues out a jet of diameter 12.75 cm diameter at a vena contracta. The coefficient of contraction is \_\_\_\_\_.

- Ans
- 1. 0.682
  - 2. 0.85
  - 3. 0.722
  - 4. 0.62

Q.63 The water-cement ratio is given by \_\_\_\_\_.

- Ans
- 1. Weight of water / Weight of cement
  - 2. Weight of cement / weight of water
  - 3. Weight of cement / Volume of water
  - 4. Volume of water / Weight of cement

Q.64 Which of the following types of joints is a temporary joint left between subsequent concreting operations?

- Ans
- 1. Expansion joint
  - 2. Isolation joint
  - 3. Contraction joint
  - 4. Construction joint

Q.65 The shear stress at a point in a liquid is found to be  $0.02 \text{ N/m}^2$ . The velocity gradient at this point is  $0.20 \text{ s}^{-1}$ . What will be the viscosity of the liquid (in Poise)?

- Ans
- 1. 10
  - 2. 2
  - 3. 1
  - 4. 0.4

Q.66 Which of the following test apparatus is used to determine the temperature susceptibility of bitumen?

- Ans
- 1. Ring and ball apparatus
  - 2. Pensky Marten test apparatus
  - 3. Tar viscometer
  - 4. Penetrometer

Q.67 Which method is used for the preparation of detailed estimate?

- Ans
- 1. Unit quantity method
  - 2. Bay method
  - 3. Square metre method
  - 4. Cubic content method

Q.68 Which of the following statements are correct  
In chain/tape surveying, the 3-4-5 method can be used:

- i. to setout contour line
- ii. to draw a perpendicular line to the chain line,
- iii. to draw a perpendicular offset,
- iv. to remove the obstacle to ranging.

- Ans
- 1. ii and iii
  - 2. i and iv
  - 3. iii and iv
  - 4. ii and iv

Q.69 What does the following traffic sign indicate?



- Ans
- 1. Major Road
  - 2. Narrow bridge ahead
  - 3. Railway crossing
  - 4. One way

Q.70 Select the option that is appropriate regarding the following two statements labelled Assertion and Reason.

**Assertion:** To prevent water logging, intercepting drains can be provided along the course of irrigation canals, in places where the percolation of water is detected.

**Reason:** The percolating water is intercepted by drains and the water is carried to other natural water courses.

- Ans
- 1. Both Assertion and Reason are false.
  - 2. Assertion is true, but Reason is false.
  - 3. Both Assertion and Reason are true, but Reason is not the correct explanation of Assertion.
  - 4. Both Assertion and Reason are true and Reason is the correct explanation of Assertion.

Q.71 In order to allow the seepage water to escape without dislocating the soil particles a/an \_\_\_\_\_ is provided at the downstream end of the impervious floor of a weir.

- Ans
- 1. pervious floor
  - 2. launching apron
  - 3. inverted filter
  - 4. graded filter



Q.72 The 3R Principle is a concept for \_\_\_\_\_.

- Ans
- 1. sanitation
  - 2. water treatment
  - 3. waste management
  - 4. plastic waste treatment

Q.73 During the alignment of a road by using direct ranging, the surveyor raises both the hands above his head and then, brings them down as a signal for his assistant. The correct action taken by his assistant would be \_\_\_\_\_.

- Ans
- 1. moving the ranging rod backward along the same line
  - 2. Lift the ranging rod above the knee level
  - 3. considering that the ranging rod is at correct position
  - 4. moving the ranging rod forward along the same line

Q.74 Which of the following statements is INCORRECT?

- Ans
- 1. Flocculation is a chemical technique that is directed towards the destabilisation of charged particles and the coagulation promotes the agglomeration of stabilised particles.
  - 2. Filters purify water through the following four different processes: mechanical straining, flocculation and sedimentation, biological metabolism and electrolyte charges charging.
  - 3. Activated carbon is a de-chlorinating agent.
  - 4. In plain sedimentation tanks, the removal of particles is independent of the depth of the sedimentation tank.

Q.75 The soil component with particles passing through 4.75 mm IS sieve but retained on 75 micron IS sieve, is known as \_\_\_\_\_.

- Ans
- 1. residue
  - 2. sand
  - 3. cobble
  - 4. mud

Q.76 Which of the following statements are correct with respect to Mohr-Coulomb failure criteria on soils.

- I: Mohr failure envelope is approximated as straight line but in actual, it is curved.
- II: Mohr failure envelope is approximated as a curved line but in actual, it is straight.
- III: The Mohr circle drawn for soil cannot cross the Mohr failure envelope.
- IV. Cohesion  $c$  and angle of internal friction  $\phi$  are fundamental properties of soil and are independent of testing conditions.

- Ans
- 1. II and III
  - 2. I and IV
  - 3. I and III
  - 4. II and IV

Q.77 In triangulation, the point at which astronomical observations for the azimuth and the longitude are made by use of Laplace equation is called \_\_\_\_\_.

- Ans
- 1. Laplace station
  - 2. subsidiary station
  - 3. base station
  - 4. base line

Q.78 Which of the following methods is used for designing a turnout taking off from a straight railway track?

- Ans
- 1. Westergaard's method
  - 2. Coles method
  - 3. Rankine's method
  - 4. Coulomb's method

Q.79 For construction of WBM roads, which of the following is the correct sequence of operation after spreading the crushed aggregate?

- Ans
- 1. Dry rolling, wet rolling, application of binding material, filling voids with screening
  - 2. Filling voids with screening, application of binding material, dry rolling, wet rolling
  - 3. Dry rolling, filling voids with screening, wet rolling, application of binding material
  - 4. Wet rolling, application of binding material, dry rolling, filling voids with screening

Q.80  $EIy = -\frac{5}{6}x^3 + 0 \cdot x + \frac{5}{2}(x - 6)^3$  is the equation of deflection obtained by using Macaulay's method for the beam shown in the following figure. Find the slope at A. Given  $EI = 10 \times 10^{13} \text{ Nmm}^2$ .

Where  $x$  = horizontal distance measured from support A

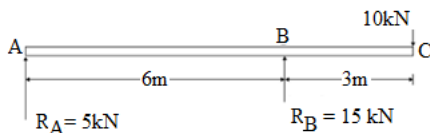

- Ans
- 1. 0.0003 radians
  - 2. 0.00015 radians
  - 3. 0.0015 radians
  - 4. 0.003 radians

Q.81 How is municipal solid waste classified on the basis of its source?

- Ans
- 1. Industrial waste and non-industrial waste
  - 2. House refuse, street refuse and trade refuse
  - 3. Residential waste and industrial waste
  - 4. Residential refuse and non-residential refuse

Q.82 In steel and iron works, dimensions excepting cross-section and thickness of plate shall be measured to nearest \_\_\_\_\_ m except for reinforcement in reinforced concrete works.

- Ans
- 1. 0.002
  - 2. 0.003
  - 3. 0.001
  - 4. 0.005

Q.83 If Reynolds number is less than 500, the flow is said to be laminar for the:

- Ans
- 1. pipe flow
  - 2. free surface flow
  - 3. flow between parallel plates
  - 4. flow through soil

Q.84 Consider the following statements with respect to cubical content method.

I. This is a preliminary estimate.

II. This is an approximate estimate.

Which of the following options is true?

- Ans
- 1. Only statement II is true
  - 2. Only statement I is true
  - 3. Both statements I and II are true
  - 4. Both statements I and II are false

Q.85 In order to have exactly zero tensile stress at one extreme fibre of a solid circular section (dia - D) subjected to combined direct (compressive) and bending stresses, a normal point load is needed to be placed \_\_\_\_\_.

- Ans
- 1. at a radial distance  $D/4$  from the centre
  - 2. at a radial distance  $D/6$  from the centre
  - 3. at a radial distance  $D/3$  from the centre
  - 4. beyond a distance of  $3D/8$  measured towards the core from the periphery

Q.86 A tank has height and width as 4m and 3m, respectively. Determine the total water force, in kN, acting on the bottom of the tank when it is completely filled with water. Take density of water as  $1000 \text{ kg/m}^3$  and acceleration due to gravity as  $9.81 \text{ m/sec}^2$  (Take the length of tank as 3m.)

- Ans
- 1. 351.26
  - 2. 345.13
  - 3. 400.57
  - 4. 353.16

Q.87 Calculate the volume of earthwork between two sections 40 m apart, if the mid sectional area between the sections is  $15 \text{ m}^2$ .

- Ans
- 1.  $750 \text{ m}^3$
  - 2.  $500 \text{ m}^3$
  - 3.  $450 \text{ m}^3$
  - 4.  $600 \text{ m}^3$

Q.88 If a steel column is designed for its stability, then the slenderness ratio is defined as the:

- Ans
- 1. ratio of the least lateral dimension to the length
  - 2. ratio of the length to the maximum lateral dimension
  - 3. ratio of the length to the least lateral dimension
  - 4. ratio of the length to the depth

Q.89 Select the INCORRECT statement regarding purification of water.

- Ans
- 1. Type-1 settling involves Stock's law.
  - 2. Screening is done before plain sedimentation.
  - 3. Sedimentation aided with coagulation is better than plain sedimentation.
  - 4. Plain sedimentation is also known as type-2 settling.

Q.90 Which of the following statements about sanitary landfilling is INCORRECT?

- Ans
- 1. In the sanitary landfilling, filling of refuse is actually carried out by dividing the entire landfill area into smaller portions called cells.
  - 2. Refuse is dumped into a low-lying area.
  - 3. Waste is stabilised by the aerobic process alone.
  - 4. Another name of sanitary landfilling is controlled tipping.

Q.91 Which of the following is NOT the remedial measure to prevent water hammer through pipes?

- Ans
- 1. Installing water hammer arrestors
  - 2. Drain your pipes and refill them to create new air chambers
  - 3. Creating vacuum by closing valve
  - 4. Tighten mounting straps to hold pipes in place

Q.92 Which of the given option provides the effective width of an isolated T- beam of RCC as per IS 456-2000? Assume -  $b_f$  = effective width of flange,  $l_0$  = distance between points of zero moments in the beam,  $b_w$  = breadth of the web,  $D_f$  = thickness of flange and  $b$  = actual width of the flange.

- Ans
- 1.  $(\frac{l_0}{6}) + b_w + 6 D_f$
  - 2.  $(\frac{l_0}{12}) + b_w + 3 D_f$
  - 3.  $[0.5 l_0 / \{(\frac{l_0}{b}) + 4\}] + b_w$
  - 4.  $[l_0 / \{(\frac{l_0}{b}) + 4\}] + b_w$

Q.93 When the instrument is stationed near point P, the staff readings at point P and Q are 1.800 m and 2.600 m, respectively. When the instrument is stationed near point Q, the staff readings at P and Q are 1.500 m and 2.400 m, respectively. R.L. of point P is 100 m. Find the R.L. of point Q.

- Ans
- 1. 98.5 m
  - 2. 97.4 m
  - 3. 100.85 m
  - 4. 99.15 m

Q.94 As per IRC standards, an octagon with white border and red background is a \_\_\_\_\_ sign.

- Ans
- 1. accident prone area
  - 2. no parking
  - 3. stop
  - 4. yield

Q.95 If the whole circle bearing of a line is zero degrees, then the reduced bearing of the line is in the \_\_\_\_\_ direction.

- Ans
- 1. south
  - 2. north
  - 3. west
  - 4. east

Q.96 The maximum water-cement ratios for plain cement concrete and reinforced cement concrete under severe exposure conditions are \_\_\_ and \_\_\_ respectively. Consider the aggregates are normal weight with 20 mm nominal maximum size.

- Ans
- 1. 0.45; 0.45
  - 2. 0.50; 0.45
  - 3. 0.40; 0.40
  - 4. 0.60; 0.50

Q.97 Find the effective length of an isolated cantilever RCC beam as per IS 456-2000, where the length from the free end to the face of support is 1 m, the effective depth of the beam, is 400 mm and the width of support is 300 mm.

- Ans
- 1. 1.3 m
  - 2. 1.15 m
  - 3. 1.4 m
  - 4. 1.2 m

Q.98 What is the interval at which expansion and contraction joints are provided in India for smooth interface laid in winter?

- Ans
- 1. 90 to 120 metres
  - 2. 80 to 90 metres
  - 3. 120 to 140 metres
  - 4. 50 to 60 metres

Q.99 The mean depth is calculated by \_\_\_\_\_ the depths of two consecutive sections.

- Ans
- 1. adding
  - 2. averaging
  - 3. multiplying
  - 4. subtract

Q.100 If a device consists of one inlet and one outlet and the volume flow rates at the inlet and at the outlet are equal, then the flow through the device:

- Ans
- 1. is not necessarily steady
  - 2. must be steady
  - 3. must be laminar
  - 4. must be uniform

## Junior Engineer Civil Mechanical and Electrical Examination 2024 Paper I

Exam Date	07/06/2024
Exam Time	5:00 PM - 7:00 PM
Subject	Junior Engineer 2024 Electrical Paper I

### Section : General Intelligence and Reasoning

**Q1** Select the correct mirror image of the given figure when the mirror is placed at OG as shown below.

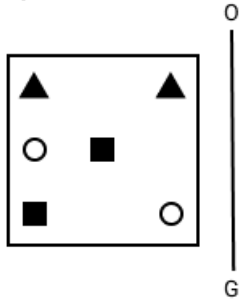

- Ans
1.
  2.
  3.
  4.

**Q2** EHDL is related to ILZH in a certain way based on the English alphabetical order. In the same way, TFRA is related to XJNW. To which of the following is JUIP related, following the same logic?

- Ans
1. MYDL
  2. NZEK
  3. MZDK
  4. NYEL

**Q3** In a certain code language, 'CASE' is coded as '8426' and 'SLIP' is coded as '9275'. What is the code for 'S' in the given language?

- Ans
1. 6
  2. 2
  3. 8
  4. 9

Q4 The position(s) of how many letters will remain unchanged if each of the letters in the word ABSOLUTE is arranged in the reverse of the English alphabetical order?

- Ans
- 1. One
  - 2. Two
  - 3. Three
  - 4. Four

Q5 What should come in place of ? in the given series?  
6, 30, 174, ?, 6222, 37326

- Ans
- 1. 1098
  - 2. 1008
  - 3. 1038
  - 4. 1058

Q6 In a certain code language, 'LVCO' is coded as '12-22-3-15' and 'GIPN' is coded as '7-9-16-14'. What is the code for 'ZAPG' in the given language?

- Ans
- 1. 24-5-14-8
  - 2. 22-2-11-5
  - 3. 26-1-16-7
  - 4. 22-5-15-6

Q7 What should come in place of the question mark (?) in the given series?  
11, 18, 25, 32, 39, ?

- Ans
- 1. 44
  - 2. 45
  - 3. 46
  - 4. 43

Q8 A, B, C, D, E, F, and G are sitting around a circular table, facing away from the centre (not necessarily in the same order). Only 3 people sit between B and D when counted from the left of D. B sits second to the left of E. G sits to the immediate right of C. A is not an immediate neighbour of D. Who is sitting to the immediate right of E?

- Ans
- 1. B
  - 2. D
  - 3. A
  - 4. F

Q9 What should come in place of the question mark (?) in the given series based on the English alphabetical order?  
UTW, SRU, QPS, ONQ, MLO, ?

- Ans
- 1. KJN
  - 2. KJM
  - 3. LJM
  - 4. LKN

Q10 What should come in place of the question mark (?) in the given series based on the English alphabetical order?  
LOR, PSV, TWZ, XAD, BEH, ?

- Ans
- 1. EIM
  - 2. GKL
  - 3. FJM
  - 4. FIL

Q.11 What should come in place of the question mark (?) in the given series based on the English alphabetical order?  
FIK, GJL, HKM, ILN, ?

- Ans
- 1. JMO
  - 2. JOM
  - 3. OJM
  - 4. OMJ

Q.12 What will come in the place of '?' in the following equation, if '+' and '-' are interchanged and 'x' and '÷' are interchanged?  
 $10 \div 8 \times 4 - 6 + 2 = ?$

- Ans
- 1. 22
  - 2. 24
  - 3. 28
  - 4. 26

Q.13 In a certain code language,  
'A + B' means 'A is the wife of B',  
'A - B' means 'A is the father of B',  
'A x B' means 'A is the sister of B', and  
'A ÷ B' means 'A is the mother of B'.  
How is Q related to Y if 'Q + K - T x D ÷ Y'?

- Ans
- 1. Father
  - 2. Mother's mother
  - 3. Mother's brother
  - 4. Father's father

Q.14 What should come in place of the question mark (?) in the given series based on the English alphabetical order?  
MOK, LNJ, KMI, JLH, ?

- Ans
- 1. IKG
  - 2. HJG
  - 3. HPJ
  - 4. IKH

Q.15 'AC 2' is related to 'DF 8' in a certain way based on the English alphabetical and numerical order. In the same way, 'IK 5' is related to 'LN 125'. To which of the following is 'PR 7' related following the same logic?

- Ans
- 1. SU 343
  - 2. RU 343
  - 3. TU 216
  - 4. SU 216

Q.16 What will come in place of the question mark (?) in the following equation if '+' and 'x' are interchanged and '-' and '÷', interchanged?  
?

$$4 + 11 \times 48 - 6 \div 3 = ?$$

- Ans
- 1. 49
  - 2. 53
  - 3. 46
  - 4. 51

Q.17 DCHE is related to HFPJ in a certain way based on the English alphabetical order. In the same way, CABF is related to FBDL. To which of the following is FIHE related, following the same logic?

- Ans
- 1. PRLJ
  - 2. LRPJ
  - 3. PLRJ
  - 4. LPRG



Q.18 14 is related to 54 following a certain logic. Following the same logic, 9 is related to 24. To which of the following is 21 related following the same logic?  
 (NOTE: Operations should be performed on the whole numbers, without breaking down the numbers into their constituent digits. E.g. 13 – Operations on 13 such as adding / subtracting /multiplying to 13 can be performed. Breaking down 13 into 1 and 3 and then performing mathematical operations on 1 and 3 is not allowed.)

- Ans
- 1. 96
  - 2. 90
  - 3. 89
  - 4. 99

Q.19 In a certain code language, 'HOPE' is coded as '7395' and 'OURS' is coded as '6582'.  
 What is the code for 'O' in the given code language?

- Ans
- 1. 6
  - 2. 7
  - 3. 9
  - 4. 5

Q.20 If A means +, B means -, C means  $\times$  and D means  $\div$ , then what will come in place of the question mark (?) in the following equation?

$$21 D 7 C 4 A 10 B 13 = ?$$

- Ans
- 1. 8
  - 2. 9
  - 3. 11
  - 4. 10

Q.21 E, F, G, H, P, Q, and R, are sitting around a circular table facing the centre (not necessarily in the same order) . Only three people sit between P and G when counted from the right of P. Only F sits between R and P when counted from the left of P. Only two people sit between R and E when counted from the left of R. H is NOT an immediate neighbour of G.  
 How many people sit between F and Q when counted from the left of F?

- Ans
- 1. One
  - 2. Four
  - 3. Three
  - 4. Two

Q.22 Select the correct mirror image of the given figure when the mirror is placed at MN as shown below.

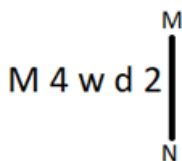

- Ans
- 1. d 2 w 4 M
  - 2. 5 b w 4 W
  - 3. 7 p w 4 M
  - 4. 5 b w 4 M

Q.23 In a certain code language, 'GROW' is coded as '5397' and 'WILD' is coded as '6942'.

What is the code for 'W' in the given code language?

- Ans
- 1. 9
  - 2. 6
  - 3. 7
  - 4. 2

Q.24 Select the option in which the numbers share the same relationship as that shared by the given pairs of numbers.

100 : 90

70 : 60

(NOTE: Operations should be performed on the whole number, without breaking down the numbers into its constituent digits. E.g. 13- Operations on 13 such as adding/subtracting/multiplying etc. to 13 can be performed. Breaking down 13 into 1 and 3 and then performing mathematical operations on 1 and 3 is NOT allowed.)

- Ans
- 1. 90 : 70
  - 2. 150 : 145
  - 3. 130 : 110
  - 4. 130 : 120

Q.25 Read the given statements and conclusions carefully. Assuming that the information given in the statements is true, even if it appears to be at variance with commonly known facts, decide which of the given conclusions logically follow(s) from the statements.

Statements:

All parrots are rats.

Some rats are lambs.

No lamb is a horse.

Conclusions:

(I) All rats are horses.

(II) Some lambs are parrots.

- Ans
- 1. Both conclusions (I) and (II) follow
  - 2. Neither conclusion (I) nor (II) follows
  - 3. Only conclusion (I) follows
  - 4. Only conclusion (II) follows

Q.26 Select the set in which the numbers are related in the same way as are the numbers of the following sets.

(NOTE : Operations should be performed on the whole numbers, without breaking down the numbers into its constituent digits. E.g. 13 – Operations on 13 such as adding /subtracting /multiplying etc. to 13 can be performed. Breaking down 13 into 1 and 3 and then performing mathematical operations on 1 and 3 is not allowed)

(9, 100, 90)

(11, 120, 110)

- Ans
- 1. (13, 260, 130)
  - 2. (14, 164, 154)
  - 3. (15, 130, 120)
  - 4. (12, 130, 120)

Q.27 This question consists of a pair of words which have a certain relationship to each other. Select the pair which has the same relationship.

(The words must be considered as meaningful English words and must not be related to each other based on the number of letters/number of consonants/vowels in the word.)

Brazil : Real

- Ans
- 1. Kenya : Yen
  - 2. Cuba : Euro
  - 3. Indonesia : Rial
  - 4. Malaysia : Ringgit

Q.28 What should come in place of the question mark (?) in the given series?

18, 30, 42, 54, 66, ?

- Ans
- 1. 78
  - 2. 82
  - 3. 73
  - 4. 70

Q.29 Select the figure from the options that can replace the question mark (?) and complete the given pattern.

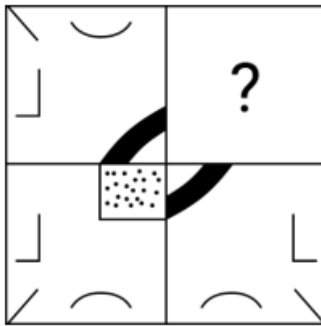

Ans

- 1.
- 2.
- 3.
- 4.

Q.30 DGFB is related to EFGA in a certain way based on the English alphabetical order. In the same way, EGHC is related to FFIB. To which of the following is FDHB related, following the same logic?

- Ans
- 1. GCAS
  - 2. GCAO
  - 3. GCER
  - 4. GCIA

Q.31 Select the option in which the given figure is embedded (rotation is NOT allowed).

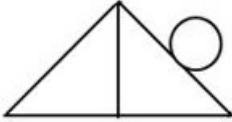

Ans

- 1.
- 2.
- 3.
- 4.

Q.32 How many triangles are there in the given figure?

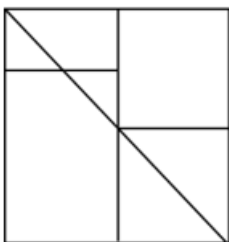

- Ans
- 1. 7
  - 2. 10
  - 3. 9
  - 4. 8

Q.33 In a certain code language,  
 'A + B' means 'A is the mother of B',  
 'A - B' means 'A is the brother of B',  
 'A × B' means 'A is the sister of B', and  
 'A ÷ B' means 'A is the husband of B'.  
 How is H related to E if 'A - B ÷ H + C × D + E'?

- Ans
- 1. Mother's sister
  - 2. Mother's mother
  - 3. Mother
  - 4. Daughter

Q.34 Select the option figure in which the given figure is embedded as its part (rotation is NOT allowed).



- Ans
- 1.
  - 2.
  - 3.
  - 4.

Q.35 Six babies Ria, Sia, Tia, Urja, Vani and Winnie are born one after the other but not necessarily in the same order. All of them were born in different cities. Only two babies were born before the one who was born in Raipur. Only one baby was born between Sia, who was born in Delhi and the baby born in Raipur. Tia was born before Urja and just after the baby born in Haridwar. Tia was not born in Raipur. Ria was born in Bhopal and just before Vani. Tia is born immediately before the baby born in Ballia. Winnie was not born in Pune. Who was born just after Sia and in which city?

- Ans
- 1. Urja, Raipur
  - 2. Ria, Bhopal
  - 3. Vani, Raipur
  - 4. Tia, Pune

Q.36 Arrange the following words in which they appear in an English dictionary and select the correct option.

1. Helical
2. Helium
3. Heighten
4. Hellenic
5. Heiress

- Ans
- 1. 41352
  - 2. 35124
  - 3. 53412
  - 4. 43152

Q.37 2 is related to 26 following a certain logic. Following the same logic, 4 is related to 52. To which of the following is 7 related following the same logic?

(NOTE: Operations should be performed on the whole numbers, without breaking down the numbers into its constituent digits. E.g. 13 – Operations on 13 such as adding /subtracting /multiplying etc. to 13 can be performed. Breaking down 13 into 1 and 3 and then performing mathematical operations on 1 and 3 is not allowed.)

- Ans
- 1. 25
  - 2. 27
  - 3. 72
  - 4. 91

Q.38 18 is related to 162 following a certain logic. Following the same logic, 16 is related to 144. To which of the following is 25 related to following the same logic?

(NOTE: Operations should be performed on the whole numbers, without breaking down the numbers into its constituent digits. E.g. 13 – Operations on 13 such as adding /subtracting /multiplying etc. to 13 can be performed. Breaking down 13 into 1 and 3 and then performing mathematical operations on 1 and 3 is not allowed.)

- Ans
- 1. 215
  - 2. 225
  - 3. 235
  - 4. 245

Q.39 Select the correct option that indicates the arrangement of the following words in a logical and meaningful order.

1. Cockroach
2. Owl
3. Ant
4. Horse
5. Fox

- Ans
- 1. 3, 4, 1, 2, 5
  - 2. 3, 1, 2, 5, 4
  - 3. 3, 2, 5, 4, 1
  - 4. 3, 5, 4, 1, 2

Q.40 Read the given statements and conclusions carefully. Assuming that the information given in the statements is true, even if it appears to be at variance with commonly known facts, decide which of the given conclusions logically follow(s) from the statements.

Statements: All girls are honest. Priya is honest.

Conclusion 1: Priya is a girl.

Conclusion 2: All honest people are girls.

- Ans
- 1. Only conclusion (1) follows
  - 2. Only conclusion (2) follows
  - 3. Both conclusion (1) and conclusion (2) follow
  - 4. None of the conclusions follow

Q.41 Which two numbers should be interchanged to make the given equation correct?

$$(165 \div 3) + (135 \div 5) - 45 + 33 = 66$$

(Note: Interchange should be done of entire number and not individual digits of a given number)

- Ans
- 1. 165 and 135
  - 2. 45 and 3
  - 3. 45 and 33
  - 4. 33 and 5

Q.42 Select the word-pair that best represents a similar relationship to the one expressed in the pair of words given below.  
(The words must be considered as meaningful English words and must not be related to each other based on the number of letters/number of consonants/vowels in the word.)

Greece : Athens

- Ans
- 1. Ireland : Dublin
  - 2. Indonesia : Tehran
  - 3. Norway : Muscat
  - 4. Jordan : Tokyo

Q.43 Manoj starts from his home and drives 4 km towards the north. He then takes a left turn, drives 5 km, turns right, and drives 9 km. He then takes a left turn and drives 3 km and turns left then drives 5 km to reach his office.  
In which direction is the office with respect to his home?  
(All turns are 90° turns only, unless specified.)

- Ans
- 1. North-east
  - 2. West
  - 3. South-east
  - 4. North-west

Q.44 Select the triad in which the numbers are related to each other in the same way as are the numbers of the given triads.  
(NOTE: Operations should be performed on the whole numbers, without breaking down the numbers into its constituent digits. E.g. 13 – Operations on 13 such as adding /deleting/multiplying etc. to 13 can be performed. Breaking down 13 into 1 and 3 and then performing mathematical operations on 1 and 3 is not allowed.)  
(12, 9, 96)  
(14, 7, 84)

- Ans
- 1. (17, 12, 170)
  - 2. (15, 8, 130)
  - 3. (10, 12, 120)
  - 4. (18, 11, 180)

Q.45 PTOS is related to NRMQ in a certain way based on the English alphabetical order. In the same way, JNIM is related to HLGK. To which of the following is MQLP related, following the same logic?

- Ans
- 1. OKNJ
  - 2. OKJN
  - 3. KONJ
  - 4. KOJN

Q.46 Sandeep starts walking towards the north from a point and walks 30 m. He turns to the right and walks 30 m. He turns to the left and walks 20 m. He turns to the left and walks 30 m. Finally, he turns to the left and walks 30 m. How far is he now from the starting point?  
(All turns are 90 degrees turns only unless specified.)

- Ans
- 1. 30 m
  - 2. 10 m
  - 3. 15 m
  - 4. 20 m

Q.47 The position(s) of how many letters will remain unchanged if each of the letters in the word HARDEST is arranged in the English alphabetical order?

- Ans
- 1. Two
  - 2. Three
  - 3. Zero
  - 4. One

Q.48 Select the figure that is embedded as a part of the main figure (X).  
(Rotation is NOT allowed.)

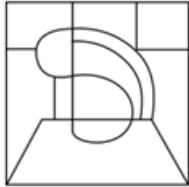

(X)

- Ans
- 1.
  - 2.
  - 3.
  - 4.

Q.49 What should come in place of the question mark (?) in the given series based on the English alphabetical order?

HKI GLH FMG ENF ?

- Ans
- 1. DUE
  - 2. CDE
  - 3. POE
  - 4. DOE

Q.50 What should come in place of the question mark (?) in the given series based on the English alphabetical order?  
LSC, NVG, PYK, RBO, ?

- Ans
- 1. WHI
  - 2. TES
  - 3. QDU
  - 4. UGT



**Q.1 Which sulphur containing preservative is used to increase the shelf life of meat products such as fresh sausages and burgers?**

- Ans
- 1. Sodium metabisulphite
  - 2. Sodium polysulfides
  - 3. Sodium thiosulfate
  - 4. Sodium phenyl sulfide

**Q.2 Which organelle is responsible for producing ATP, the cell's energy currency?**

- Ans
- 1. Nucleus
  - 2. Mitochondrion
  - 3. Golgi apparatus
  - 4. Endoplasmic reticulum

**Q.3 It is hot outside. It is cloudy and raining most of the time. It is the month of June. Which season is it?**

- Ans
- 1. Winter
  - 2. Summer
  - 3. Monsoon
  - 4. Spring

**Q.4 Who among the following eminent musicians is a famous tabla player?**

- Ans
- 1. Ustad Bade Gulam Ali Khan
  - 2. Ustad Moinuddin Khan
  - 3. Ustad Zakir Hussain
  - 4. Ustad Abdul Rashid Khan

**Q.5 What is the unit of electric current?**

- Ans
- 1. Ohm
  - 2. Watt
  - 3. Volt
  - 4. Ampere

**Q.6 According to Article 243 I of the Constitution, the Governor of a state constitutes the Finance Commission for every \_\_\_\_\_.**

- Ans
- 1. 2 years
  - 2. 3 years
  - 3. 5 years
  - 4. 7 years

**Q.7 In how many different combinations do the standard ASCII codes come?**

- Ans
- 1. 64
  - 2. 256
  - 3. 128
  - 4. 100

**Q.8 Which of the following is NOT an animal of Phylum Chordate?**

- Ans
- 1. Frog
  - 2. Snake
  - 3. Rabbit
  - 4. Earthworm

**Q.9** The Y-shaped proteinaceous structure produced by the immune cells to defend our body against harmful bacteria and viruses are known as:

- Ans
- 1. immunoglobulin
  - 2. amino acids
  - 3. collagen
  - 4. haemoglobin

**Q.10** The process of measuring various physical and chemical properties of the rocks and fluids within a wellbore is known as:

- Ans
- 1. well logging
  - 2. drilling
  - 3. reservoir modelling
  - 4. enhanced oil recovery techniques

**Q.11** Rank the following states in descending order of their percentage share of the population in the country's population, as per Census 2011.

**Bihar, West Bengal, Rajasthan, Madhya Pradesh**

- Ans
- 1. Rajasthan-Madhya Pradesh-Bihar-West Bengal
  - 2. Madhya Pradesh-Bihar-Rajasthan-West Bengal
  - 3. Bihar-West Bengal-Madhya Pradesh-Rajasthan
  - 4. Bihar-Madhya Pradesh-Rajasthan-West Bengal

**Q.12** According to Census of India 2011, which is the second most populated state?

- Ans
- 1. Bihar
  - 2. Tamil Nadu
  - 3. Maharashtra
  - 4. Rajasthan

**Q.13** Who said, "Literacy in itself is not Education"?

- Ans
- 1. Jawaharlal Nehru
  - 2. Bal Gangadhar Tilak
  - 3. Mahatma Gandhi
  - 4. BR Ambedkar

**Q.14** Who introduced the Digital Personal Data Protection Bill in the Lok Sabha on 3 August 2023?

- Ans
- 1. Subrahmanyam Jaishankar
  - 2. Piyush Goyal
  - 3. Anurag Singh Thakur
  - 4. Ashwini Vaishnaw

**Q.15** Which of the following is a simple monocarboxylic acid containing two carbons?

- Ans
- 1. Capric acid
  - 2. Valeric acid
  - 3. Acetic acid
  - 4. Palmitic acid

Q.16 Which organelle contains enzymes that help break down fatty acids and detoxify certain compounds in the cell?

- Ans
- 1. Vacuole
  - 2. Centriole
  - 3. Lysosome
  - 4. Peroxisome

Q.17 Which of the following is the structural and functional unit of an organism?

- Ans
- 1. Nucleus
  - 2. Mitochondria
  - 3. ATP
  - 4. Cell

Q.18 Who is the governor of Reserve Bank of India as of May 2023?

- Ans
- 1. Urjit Patel
  - 2. Shaktikanta Das
  - 3. Raguram Rajan
  - 4. YV Patel

Q.19 Identify the incorrect pair (River and its origin) from the following.

- Ans
- 1. Godavari - Nasik district
  - 2. Narmada - Amarkantak hills
  - 3. Krishna - Brahmagiri range
  - 4. Tapi - Satpura ranges

Q.20 When was the 'Mahatma Gandhi Series' of Indian Bank notes started?

- Ans
- 1. 2000
  - 2. 1996
  - 3. 1994
  - 4. 1991

Q.21 What is the difference between a somatic cell and a reproductive cell?

- Ans
- 1. Somatic cells undergo mitotic cell division while reproductive cells undergo meiotic cell division.
  - 2. The somatic cells have mitochondria but the reproductive cells do not have any mitochondria.
  - 3. Somatic cells do not contain any chromosome while reproductive cells have their own chromosome.
  - 4. The somatic cell and reproductive cell are neither diploid nor haploid.

Q.22 Which is the correct formula to calculate the formula unit mass of a compound?

- Ans
- 1. Multiplication of all the atomic masses of all the atoms within the formula
  - 2. Summation of all the atomic weights of all the atoms within the formula
  - 3. Summation of all the atomic masses of all the atoms within the formula
  - 4. Multiplication of all the atomic weights of all the atoms within the formula

Q.23 Which Article of the Constitution of India mentions about enlargement of the jurisdiction of the Supreme Court?

- Ans
- 1. Article 138
  - 2. Article 140
  - 3. Article 142
  - 4. Article 144

Q.24 Which of the following does NOT affect the changes in the states of matter?

- A) Changing the kinetic energy in the particles of the matter
- B) Changing the temperature of the matter
- C) Changing the pressure on the matter
- D) Changing the colour of the matter

- Ans
- 1. D
  - 2. C
  - 3. B
  - 4. A

Q.25 Why is it safer for our hands to use a wooden spoon while cooking in a hot pan instead of using a metallic spoon?

- Ans
- 1. Wood is a good conductor of heat and helps in cooking.
  - 2. Wood adds nice flavours to the food being cooked.
  - 3. Wood is an insulator and does not heat up.
  - 4. Wood helps the food cook faster.

Q.26 Which of the following is the domestic first-class cricket championship in India?

- Ans
- 1. Durand Cup
  - 2. Ranji Trophy
  - 3. Thomas Cup
  - 4. Santosh Trophy

Q.27 Where is the headquarters of the National Remote Sensing Centre (NRSC)?

- Ans
- 1. Hyderabad
  - 2. Bhubaneshwar
  - 3. Bhopal
  - 4. Lucknow

Q.28 Certain grass-eating animals complete the digestion of food in two processes. First, they swallow partially digested food and then they regurgitate and chew upon that food again. What are such animals known as?

- Ans
- 1. Heterotrophs
  - 2. Regurgitates
  - 3. Autotrophs
  - 4. Ruminants

Q.29 Which of the following are NOT contents of soil?

- Ans
- 1. Bacteria and fungi
  - 2. Grains of stones
  - 3. Steroids
  - 4. Minerals

Q.30 In which of the following countries was the revolutionary Ghadar Party formed?

- Ans
- 1. Germany
  - 2. England
  - 3. The US
  - 4. Switzerland

Q.31 Which agency supported the Bihar State Rural Livelihoods Mission (Jeevika) in developing digital financial services?

- Ans
- 1. SBI
  - 2. RBI
  - 3. SIDBI
  - 4. SEBI

Q.32 \_\_\_\_\_, a woman educated at home at Poona, published a book, *Stripurushtulna*, criticising the social differences between men and women.

- Ans
- 1. Pandita Ramabai
  - 2. Savitribai Phule
  - 3. Tarabai Shinde
  - 4. Kadambini Devi

Q.33 In which of the following Olympic Games did Dipa Karmakar participate?

- Ans
- 1. Rio 2016
  - 2. London 2012
  - 3. Athens 2004
  - 4. Beijing 2008

Q.34 Which ministry introduced the Press and Registration of Periodicals (PRP) Bill in Rajya Sabha on 1 August 2023?

- Ans
- 1. Ministry of Electronics and Information Technology
  - 2. Ministry of Commerce and Industry
  - 3. Ministry of Information and Broadcasting
  - 4. Ministry of Corporate Affairs

Q.35 According to Census of India 2011, which state/union territory has the second highest sex ratio?

- Ans
- 1. Chandigarh
  - 2. Tamil Nadu
  - 3. Puducherry
  - 4. Himachal Pradesh

Q.36 The \_\_\_\_\_ Health Card Scheme was launched by the Government of India in the year 2014-15.

- Ans
- 1. Soil
  - 2. Forest
  - 3. Water
  - 4. Mineral

Q.37 Which directive principle was added by the 97<sup>th</sup> Amendment Act 2011?

- Ans
- 1. Organisation of village panchayats
  - 2. Promotion of co-operative societies
  - 3. Separation of judiciary from executive
  - 4. Uniform civil code for the citizens

Q.38 Who among the following became the first woman Chief Executive and Chairperson of the Railway Board on 1 September 2023?

- Ans
- 1. Maria Kalavathy
  - 2. Surekha Bhosale
  - 3. Jaya Varma Sinha
  - 4. Kabitha Mathur

Q.39 Which term refers to the increasing concentration of toxins within each successive link in the food chain?

- Ans
- 1. Facilitation
  - 2. Biomagnification
  - 3. Stratification
  - 4. Denitrification

Q.40 How does the 'Shram Suvidha Portal' of the Ministry of Labour and Employment contribute to transparency in labour law enforcement?

- Ans
- 1. By providing child care centres
  - 2. By allowing women to work night shifts
  - 3. By uploading inspection reports within 48 hours
  - 4. By ensuring minimum wages for all employees

Q.41 The Battle of Chandawar was fought between Muhammad Ghori and \_\_\_\_\_, a ruler of the Gahadavala dynasty, in 1194.

- Ans
- 1. Vijayachandra
  - 2. Jaichand
  - 3. Harishchandra
  - 4. Govindachandra

Q.42 Which Article of the Constitution of India prohibits discrimination on the grounds of religion, race and caste?

- Ans
- 1. Article 15
  - 2. Article 16
  - 3. Article 17
  - 4. Article 18

Q.43 What is the value of 1 electron volt (eV), which is especially used for nuclear science?

- Ans
- 1.  $2.202 \times 10^{-11}$  joules
  - 2.  $1.202 \times 10^{-15}$  joules
  - 3.  $1.902 \times 10^{-10}$  joules
  - 4.  $1.602 \times 10^{-19}$  joules

Q.44 Which of the following is a popular email client software?

- Ans
- 1. Microsoft Word
  - 2. Adobe Photoshop
  - 3. Mozilla Firefox
  - 4. Microsoft Outlook

Q.45 When did the government launch Start-up India Seed Fund Scheme?

- Ans
- 1. 2020
  - 2. 2021
  - 3. 2022
  - 4. 2023

Q.46 The 42<sup>nd</sup> Constitutional Amendment Act (1976) added three new words to the Preamble i.e. socialist, secular and \_\_\_\_\_.

- Ans
- 1. fraternity
  - 2. republic
  - 3. democratic
  - 4. integrity

Q.47 The central government, in 2021, set up an eight-member panel for framing a new law for drugs, cosmetics and medical devices. Who headed that panel?

- Ans
- 1. Rajiv Wadhawan
  - 2. Dr. VG Somani
  - 3. AK Pradhan
  - 4. NL Meena

Q.48 Who was sworn in as the Governor of Andhra Pradesh on 24 February 2023?

- Ans
- 1. Gulab Chand Kataria
  - 2. S Abdul Nazeer
  - 3. Acharya Dev Vrat
  - 4. Pratap Shukla

Q.49 Eukaryotic organisms can have very complex functions to sustain themselves. At the cellular level, these involve several different types of chemical functions like energy production, metabolism etc. What are the membrane-bound structures called, which are present within the cell to keep each of these functionalities separate?

- Ans
- 1. Cytoplasm
  - 2. Plasma gel
  - 3. Organelles
  - 4. Nucleoid

Q.50 Who among the following related to Patiala gharana?

- Ans
- 1. Amir Khan
  - 2. Goswami Lalji Mahara
  - 3. Ghagge Nazir Khan
  - 4. Fateh Ali Khan and Ali Baksh Khan

Section : General Engineering Electrical

Q.1 How does the power factor affect the reading of a wattmeter if voltage and current are unaltered?

- Ans
- 1. The reading increases with square of the power factor.
  - 2. The reading increases with the power factor.
  - 3. The reading decreases with the power factor.
  - 4. The reading is independent of the power factor.

Q2 Which of the following statements is/are true regarding the principle of operation of a switched reluctance motor?

- 1) The motor relies on the interaction of magnetic fields to produce rotational motion.
- 2) The motor uses brushes and a commutator to produce rotational motion.
- 3) The motor uses permanent magnets to produce rotational motion.
- 4) The motor uses a series of switches to control the flow of current through its coils.

- Ans
- 1. Both 1 and 3
  - 2. Only 1
  - 3. Both 1 and 2
  - 4. Both 2 and 4

Q3 The AC ripples can be reduced in a rectifier circuit by using capacitive filter by \_\_\_\_\_ the capacitance value and by \_\_\_\_\_ the input frequency.

- Ans
- 1. decreasing; increasing
  - 2. increasing; increasing
  - 3. increasing; decreasing
  - 4. decreasing; decreasing

Q4 A sinusoidal alternating voltage of time period 36 ms has the maximum value of 250 V. Its value will reach -125 V (half the value of negative maximum) after \_\_\_\_\_ milliseconds.

- Ans
- 1. 18
  - 2. 9
  - 3. 3
  - 4. 21

Q5 Which of the following facts is correct for KCL?

- Ans
- 1. Charge accumulation may or may not be possible
  - 2. Zero charge accumulation at node
  - 3. Energy may be stored at the node
  - 4. Possibility of charge accumulation at node

Q6 Determine the force required to separate two magnetic surfaces with a contact area of  $4\pi$  cm<sup>2</sup> and the magnetic flux density across the surface is 1 wb/m<sup>2</sup>.

- Ans
- 1. 800 N
  - 2. 100 N
  - 3. 500 N
  - 4. 1000 N

Q7 The method which can be used for the speed control of an induction motor from the stator side is \_\_\_\_\_.

- Ans
- 1. V/Z control
  - 2. adding rheostats in rotor circuit
  - 3. V/F control
  - 4. V/R control

Q8 Which of the following factors will NOT affect the selection of a resistor?

- Ans
- 1. Power rating (in watts)
  - 2. Thermal resistivity
  - 3. Tolerance
  - 4. Frequency range



Q.9 How does the load factor impact the cost of a unit (kWh) of electricity?

- Ans
- 1. Higher load factor leads to lower generation costs per unit.
  - 2. Load factor only affects the demand charges, not the generation costs.
  - 3. Load factor has no impact on the generation costs per unit.
  - 4. Higher load factor leads to higher generation costs per unit.

Q.10 Which of the following testing methods is NOT used to test an AC energy meter?

- Ans
- 1. Braking test
  - 2. Creep test
  - 3. Starting test
  - 4. Long period dial test

Q.11 In regard to the construction of a synchronous alternator, hydro alternators have \_\_\_\_\_.

- Ans
- 1. high speed and smaller diameter
  - 2. larger diameter and low speed
  - 3. low speed and smaller diameter
  - 4. larger diameter and high speed

Q.12 A 400 V, 30 kVA, single-phase alternator has an effective armature resistance of  $0.3 \Omega$ . An excitation current of 20 A produces 266 A armature current on short-circuit and an EMF of 400 V on open-circuit. The synchronous impedance and synchronous reactance of the alternator are, respectively, \_\_\_\_\_.

- Ans
- 1.  $20 \Omega$  and  $0.3 \Omega$
  - 2.  $0.3 \Omega$  and  $20 \Omega$
  - 3.  $1.46 \Omega$  and  $1.5 \Omega$
  - 4.  $1.5 \Omega$  and  $1.46 \Omega$

Q.13 Consider the following statements regarding Brushless DC motors and select the correct option.

- (i) In Brushless motors, there is a provision of permanent magnets that will rotate around a moving armature.
- (ii) The brush-commutator assembly of a conventional DC motor is replaced by an electronic controller in the Brushless DC motors.
- (iii) For same kW rating, the Brushless DC motor is less expensive than the Brushed conventional DC motor.

- Ans
- 1. (i) and (iii) are false
  - 2. Only (ii) is false
  - 3. (i) and (ii) are false
  - 4. (ii) and (iii) are false

Q.14 In regard to installations of street lighting, what is the average illumination level of Class A1 installations used in important shopping centres and at road junctions?

- Ans
- 1. 40 lumens/m<sup>2</sup>
  - 2. 20 lumens/m<sup>2</sup>
  - 3. 10 lumens/m<sup>2</sup>
  - 4. 30 lumens/m<sup>2</sup>

Q.15 Which of the following is correct with reference to phasing out test on transformers?

- Ans
- 1. This test is carried out only on the 3 $\Phi$  transformer to identify primary and secondary winding in the same phase.
  - 2. This test is carried out both on 1 $\Phi$  and 3 $\Phi$  transformers to identify high-voltage winding.
  - 3. This test is carried out only on 1 $\Phi$  transformer to identify primary and secondary winding.
  - 4. This test is carried out both on 1 $\Phi$  and 3 $\Phi$  transformers to identify the primary and secondary winding.

Q.16 The torque developed in the squirrel cage induction motor with auto-starter is \_\_\_\_\_.

- Ans
- 1.  $K \times$  torque with direct switching
  - 2.  $K^2 \times$  torque with direct switching
  - 3.  $k^2$ /torque with direct switching
  - 4.  $k$ /torque with direct switching

Q.17 What will be the total active power consumed by a 3-phase, delta-connected system, which is supplied with a line voltage of 230 V, when the value of the phase current is 15 A and the current lags the voltage by 30°?

- Ans
- 1. 12.26 kW
  - 2. 10.25 kW
  - 3. 8.963 kW
  - 4. 14.63 kW

Q.18 The range of signal generating frequencies for a function generator is \_\_\_\_\_.

- Ans
- 1. 0.01 kHz to 100 kHz
  - 2. 0.01 kHz to 100 Hz
  - 3. 0.01 Hz to 100 kHz
  - 4. 0.01 Hz to 100 Hz

Q.19 Ten resistors having the same value of resistance i.e. 10 ohm, are connected in parallel. What will be the equivalent resistance of this connection?

- Ans
- 1. 2 ohm
  - 2. 1 ohm
  - 3. 5 ohm
  - 4. 100 ohm

Q.20 Two inductively coupled coils have self-inductance  $L_1=20\text{H}$  and  $L_2=320\text{H}$ . Find the maximum possible mutual inductance between the coils.

- Ans
- 1. 100 H
  - 2. 80 H
  - 3. 40 H
  - 4. 10 H

Q21 Which of the following statement is true regarding End Condenser method used for the performance analysis of medium transmission line?

- Ans
- 1. Line capacitance is lumped at the receiving end during the analysis.
  - 2. Line capacitance is considered distributed parameter during the analysis.
  - 3. Line capacitance is lumped between resistance and Inductance during analysis.
  - 4. Line capacitance is lumped at the sending end during the analysis.

Q22 Which of the following factors will NOT affect the selection of an inductor?

- Ans
- 1. Quality factor
  - 2. Current rating
  - 3. Dielectric constant
  - 4. Power loss

Q23 Which of the following statements is/are true regarding symmetrical balanced three phase supply:

- 1 Instantaneous values of power in all of the 3 phases become zero at same instant.
- 2 Phase displacement between different phases of an n-phase system is  $(\frac{360}{n})^\circ$  electrical except for the two-phase system.

- Ans
- 1. Neither 1 nor 2
  - 2. Only 2
  - 3. Only 1
  - 4. Both 1 and 2

Q24 Transmission efficiency of a transmission line increases with the \_\_\_\_\_.

- Ans
- 1. decrease in power factor and voltage
  - 2. increase in power factor and voltage
  - 3. increase in voltage only power factor remains constant
  - 4. increase in power factor but the decrease in voltage

Q25 A Lissajous patterns on a Cathode Ray Oscilloscope (CRO) has 8 vertical maximum values and 4 horizontal maximum values. The frequency of the horizontal input is 1600 Hz. Determine the frequency of the vertical input?

- Ans
- 1. 200 Hz
  - 2. 600 Hz
  - 3. 400 Hz
  - 4. 800 Hz

Q26 To prevent rusting in electric iron, the plates of the bottom surface and edges are made of \_\_\_\_\_.

- Ans
- 1. heavy chromium
  - 2. asbestos
  - 3. mica
  - 4. heavy iron

- Q.27 Which of the following statements regarding biochemical-based power plants is/are true?  
A) Methane is emitted along with carbon dioxide in aerobic digestion.  
B) Sewage gas represents a mix of carbon dioxide, methane and trace gas.  
C) Syngas is generated as a result of gasification in such a plant.

Ans  1. Only B and C  
 2. Only A and C  
 3. Only B  
 4. Only A and B

- Q.28 Which of the following is true for the performance analysis of medium transmission line using end condenser method?

Ans  1. The voltage across the load is equal to the voltage across the lumped line capacitance.  
 2. The voltage across the load is higher than the voltage across the each different distributed line capacitance.  
 3. The voltage across the load is lower than the voltage across the each different distributed line capacitance.  
 4. The voltage across the load is higher than the voltage across the lumped line capacitance.

- Q.29 A moving iron ammeter with a range of 0 to 1 amps has an internal resistance of 50 mΩ and an inductance of 0.1 MH. To increase the range to 0-10 Ampere for all operational frequencies, a shunt coil is connected. The shunt coils resistance in mΩ and time constant in milliseconds are each given as:

Ans  1. 2; 1  
 2. 11.1; 2  
 3. 2; 0.55  
 4. 5.55, 2

- Q.30 If the distance between the plates of a parallel plate capacitor is increased 10 times and the area is reduced to one-fourth, then its capacitance \_\_\_\_\_.

Ans  1. increases 2.5 times  
 2. becomes  $\frac{1}{40}$  times  
 3. becomes 40 times  
 4. becomes one half

- Q.31 When is the error under testing of energy meter directly obtained?

Ans  1. The meter under test and the rotating substandard meter constants are same.  
 2. The meter under test and the rotating substandard meter constants are 1.  
 3. The meter under test and the rotating substandard meter constants are zero.  
 4. The meter under test and the rotating substandard meter constants are different.

- Q.32 Which of the following statements is correct about inert gas metal arc welding?

Ans  1. In this method, concentration of heat is easily possible.  
 2. In this method, flux is required.  
 3. This method is particularly suitable for welding heavy metals.  
 4. In this method, concentration of heat is difficult.

Q.33 The back EMF in a DC motor opposes the supply voltage. This is explained by \_\_\_\_\_.

- Ans
- 1. Faraday's laws of electromagnetic induction
  - 2. Fleming's right hand rule
  - 3. Fleming's left hand rule
  - 4. Lenz's law

Q.34 Medium transmission lines CANNOT be analysed by using which of the following methods?

- Ans
- 1. Cognitive method
  - 2. Load end capacitance
  - 3. Nominal T method
  - 4. Nominal Pi method

Q.35 In the context of electromagnetism, if a conductor is held in the right hand with the thumb pointing in the direction of the current, then the other fingers will point towards the \_\_\_\_\_.

- Ans
- 1. direction of the magnetic field
  - 2. length of the conductor
  - 3. magnetic field intensity
  - 4. current flowing through the conductor

Q.36 In heating effect, if 'I' is the current flowing through the conductor in 't' seconds having a resistance 'R', then the electrical energy supplied is \_\_\_\_\_.

- Ans
- 1.  $IR^2t$  joules
  - 2.  $I^2Rt$  joules
  - 3.  $I^2R/t$  joules
  - 4.  $IR^2/t$  joules

Q.37 In CE configuration, the collector supply voltage  $V_{CC} = 10$  v, and  $R_C = 8$  k $\Omega$ . Determine the Quiescent point Q for zero signal if the base current is  $I_B = 15\mu A$  and  $\beta = 40$ .

- Ans
- 1.  $I_C = 1$  mA and  $V_{CE} = 7$  V
  - 2.  $I_C = 0.6$  mA and  $V_{CE} = 6$  V
  - 3.  $I_C = 0.6$  mA and  $V_{CE} = 5.2$  V
  - 4.  $I_C = 1$  mA and  $V_{CE} = 5.2$  V

Q.38 Chargeable expenses are occasionally also termed as \_\_\_\_\_.

- Ans
- 1. overhead expense
  - 2. major expense
  - 3. lump sum expense
  - 4. direct expense

Q.39 What will be the stored energy by a 100 mH inductor when 1 A current is flowing through it?

- Ans
- 1. 0.05 J
  - 2. 0.01 J
  - 3. 0.001 J
  - 4. 0.005 J

Q.40 A coil having 100 turns is placed in the magnetic field of 1m wb. Find the average EMF induced if the coil is moved in 0.2 seconds from the given field to a field of 0.4m wb.

- Ans
- 1. 3 volts
  - 2. 10 volts
  - 3. 0.3 volt
  - 4. 30 volts

Q.41 An R-L series circuit, where  $R = 10 \Omega$  and  $L = 0.056 \text{ H}$ , is connected to an AC supply of frequency 50 Hz. The magnitude of impedance of the circuit is:

- Ans
- 1.  $5.23 \Omega$
  - 2.  $20.23 \Omega$
  - 3.  $10.23 \Omega$
  - 4.  $30.23 \Omega$

Q.42 What is the meaning of the term 'load factor'?

- Ans
- 1. The ratio of peak load to average load over a year
  - 2. The ratio of total energy production to total energy consumption
  - 3. The ratio of average load to peak load over a year
  - 4. The ratio of total energy consumption to total energy production

Q.43 Which of the following materials is widely used for high-temperature heating ( $1500^\circ\text{C}$ ) applications such as in industrial furnaces and kilns?

- Ans
- 1. Bronze
  - 2. Stainless steel
  - 3. Silicon carbide
  - 4. Nickel chromium alloy

Q.44 In a brake test, the DC motor took 20 A from a 200 V supply mains. The brake pulley of radius 10 cm had an effective load of 20 kg and the speed was 10 rps. The value of BHP (in metric) is \_\_\_\_\_.

- Ans
- 1.  $1.3\pi$
  - 2.  $0.2\pi$
  - 3.  $8.8\pi$
  - 4.  $0.5\pi$

Q.45 Which of the following statements related to the speed control of DC shunt and series motors is correct?

- Ans
- 1. Field diverters and tapped field control methods are mostly used in DC shunt motors.
  - 2. In the Rheostatic control methods of shunt motors, the series resistor must be connected between the line and the motor.
  - 3. In a tapped field control when all the field turns are present in the circuit, the motor runs at the lowest speed.
  - 4. In series-parallel control, the motors are joined in parallel at lower speeds and series at higher speeds.

Q.46 The total inductance of two coupled coils in the series opposing and series aiding connections are 12 mH and 38 mH, respectively. Find the mutual inductance between the coils.

- Ans
- 1. 13 mH
  - 2. 6.5 mH
  - 3. 10 mH
  - 4. 26 mH

Q.47 Three identical impedances are connected in delta. The load is supplied by a 3-phase supply of 300 V. The line current is  $30\sqrt{3}$ A. Calculate the impedance per phase.

- Ans
- 1.  $10 \Omega$
  - 2.  $10\sqrt{3} \Omega$
  - 3.  $20 \Omega$
  - 4.  $30 \Omega$

Q.48 At higher forward voltages, a junction diode is likely to \_\_\_\_\_.

- Ans
- 1. get saturated
  - 2. break down
  - 3. burn out
  - 4. become noisy

Q.49 In order to prevent creeping in an energy meter, which of the following measures is adopted?

- Ans
- 1. Two, diametrically opposite holes are drilled on the aluminium disc.
  - 2. A temperature shunt is used on the brake magnet.
  - 3. Two, diametrically opposite holes are drilled on the central limb.
  - 4. A shading band is provided on the central limb of the shunt magnet.

Q.50 In the estimation and costing of public installations, which of the following factors is required, especially in long stretches of the road and even more on complicated intersections?

- Ans
- 1. Width of illumination Limitation of glare
  - 2. Visual guidance
  - 3. Level of luminance
  - 4. Limitations of glare

Q.51 What does the area under the Load Duration Curve represent?

- Ans
- 1. The total electricity consumption of consumers during the day
  - 2. The total power generated by a power plant during the day
  - 3. The load factor of the power station
  - 4. The total number of units generated for the period considered

Q.52 In internal wiring estimation, if the connected load is 2 kW and the supply voltage is 240 V, then the maximum load current will be \_\_\_\_\_.

- Ans
- 1. 8.33 A
  - 2. 1.14 A
  - 3. 4.33 A
  - 4. 80 A

Q.53 Which of the following statements are true for synchronous motor losses?

- A) Friction and windage losses increase with the cube of speed.
- B) The Eddy current loss is reduced by laminating the core.
- C) Copper losses are independent of load.
- D) Core losses increase with the square of the load.

- Ans
- 1. B and C
  - 2. A and D
  - 3. C and D
  - 4. A and B

Q.54 Which of the following is NOT correct with reference to delta-star type distribution transformers application?

- Ans
- 1. In delta-star type transformer, secondary voltage is in phase with the primary voltages.
  - 2. In delta-star type transformer, fault protection is one of the primary advantages.
  - 3. In delta-star type transformer, no distortion is produced by third harmonic components.
  - 4. In delta-star type transformer, large, unbalanced loads can be handled without any difficulty.

Q.55 The line voltage of a delta connected three phase circuit is 415 V. The phase voltage is:

- Ans
- 1. 240 V
  - 2. 230 V
  - 3. 415 V
  - 4. 220 V

Q.56 In a parallel resonant circuit, the input impedance of the circuit is \_\_\_\_\_.

- Ans
- 1. maximum
  - 2. minimum
  - 3. zero
  - 4. infinite

Q.57 A 4 pole, 50 Hz IM operates at 7% slip. The frequency of EMF induced in the rotor will be \_\_\_\_\_.

- Ans
- 1. 3.5 Hz
  - 2. 2.5 Hz
  - 3. 0.5 Hz
  - 4. 1.5 Hz

Q.58 Which of the following is an example of an electrostatic type instrument?

- Ans
- 1. Hot wire instrument
  - 2. Energy meter
  - 3. Kelvin multicellular voltmeter
  - 4. Wattmeter

Q.59 In a magnetic circuit, when magnetic flux is passing across the air gap, then effective area of the gap increases and magnetic flux density decreases in the gap. This effect is known as \_\_\_\_\_.

- Ans
- 1. magnetic leakage
  - 2. magnetic fringing
  - 3. magnetic hysteresis
  - 4. magnetising force

Q.60 During the tender in estimation and costing, the guarantee of the tenderer to deposit the required security and enter in to the required agreement on intimation of the acceptance of his tender is called \_\_\_\_\_.

- Ans
- 1. earned money
  - 2. valid money
  - 3. deposit money
  - 4. earnest money



Q.61 Two coupled inductors  $L_1 = 8\text{H}$  and  $L_2 = 32\text{H}$  have coefficient of coupling  $K = 0.4$ . The mutual inductance between them is

- Ans
- 1. 102.4 H
  - 2. 40 H
  - 3. 6.4 H
  - 4. 64 H

Q.62 The value of a series resistor required to limit the current through an electric bulb to 40 mA with a forward voltage drop of 4V when connected to 16 V supply is \_\_\_\_\_.

- Ans
- 1. 100  $\Omega$
  - 2. 1000  $\Omega$
  - 3. 300  $\Omega$
  - 4. 20  $\Omega$

Q.63 In regard to estimation and costing of public lighting, which of the following factors is NOT a fundamental criterion for the quality of public lighting?

- Ans
- 1. Limitations of glare
  - 2. Optical guidance
  - 3. Level of luminance
  - 4. Looping-in method

Q.64 A 4 $\Omega$  resistor has a specified maximum power dissipation of 784 W. Calculate its maximum current level.

- Ans
- 1. 16 A
  - 2. 14 A
  - 3. 10 A
  - 4. 196 A

Q.65 How many types of dependent sources are there?

- Ans
- 1. 5
  - 2. 6
  - 3. 2
  - 4. 4

Q.66 The receiving end voltage of a radial distribution network is 24 kV. What will be the sending end voltage, if the voltage drop is calculated 25% of receiving end voltage?

- Ans
- 1. 18 kV
  - 2. 36 kV
  - 3. 32 kV
  - 4. 30 kV

Q.67 The efficiency of a 60 Hz, 6-pole, 1000 rpm 3-phase induction motor is \_\_\_\_\_.

- Ans
- 1. 75.5%
  - 2. 69.3%
  - 3. 94.2%
  - 4. 83.4%

Q.68 In case of installations in commercial buildings, evenly distributed lights can be obtained by the use of lenses, which reduces \_\_\_\_\_.

- Ans
- 1. decoration
  - 2. colour
  - 3. spot light
  - 4. brightness

Q.69 Which of the following triggers the failure of successive parts?

- Ans
- 1. Non-cascade tripping
  - 2. Brown out
  - 3. Load shedding
  - 4. Incipient fault in power transformer

Q.70 Identify the INCORRECT statement regarding a nuclear power plant.

- Ans
- 1. Graphite and Boron carbides are used as control rods.
  - 2. Heavy water can be used as a coolant.
  - 3. The fuel rods contain pellets of uranium.
  - 4. The ordinary water is used as a moderator only after it is enriched with uranium.

Q.71 Which of the following types of materials shows a movement from a weaker region to a stronger region of a non-uniform magnetic field?

- Ans
- 1. Diamagnetic material
  - 2. Insulating material
  - 3. Non-magnetic material
  - 4. Paramagnetic material

Q.72 The scattering of molten metal droplets outside the weld zone, which can lead to surface irregularities is called weld \_\_\_\_\_.

- Ans
- 1. slag inclusions
  - 2. spatter
  - 3. burn-through
  - 4. under fill

Q.73 In the context of electrical signals, if the signal generated has a definite pattern that repeats itself at regular intervals of time, such a signal is called \_\_\_\_\_.

- Ans
- 1. periodic signal
  - 2. independent signal
  - 3. non-periodic signal
  - 4. dependent signal

Q.74 In the context of electromagnetism, the magnetic polarity of a coil of several turns can be determined by the \_\_\_\_\_.

- Ans
- 1. mechanism of force production
  - 2. molecular theory
  - 3. left-hand rule
  - 4. right-hand rule

Q.75 Select the correct statement for a medium overhead transmission line.

- Ans
- 1. Load current is directly proportional to the load power factor.
  - 2. Load current is inversely proportional to the square of load power factor.
  - 3. Load current is directly proportional to the square of load power factor.
  - 4. Load current is inversely proportional to the load power factor.

Q.76 In magnetism, the measure of the ease with which magnetic flux can pass through a material is called \_\_\_\_\_.

- Ans
- 1. permeance
  - 2. reluctance
  - 3. MMF
  - 4. flux density

Q.77 What is the function of the pressure spring in a three-phase energy meter?

- Ans
- 1. It maintains a constant pressure between the aluminium discs and the disc spindles.
  - 2. It provides deflection torque to the moving member.
  - 3. It provides mechanical support.
  - 4. It moves the aluminium discs in response to the torque generated by the magnetic field.

Q.78 A coil of inductance 10 H and resistance 40 ohm is connected in series with a capacitance and supplied by a source of variable frequency. If the maximum current is found at frequency 1000 rad/sec, then Q-factor of the circuit will be \_\_\_\_\_.

- Ans
- 1. 200
  - 2. 25
  - 3. 100
  - 4. 250

Q.79 What is the formula for calculating the magnitude of the mechanical force experienced by a current-carrying conductor perpendicular to the magnetic field, where B = magnetic flux density, I = Current and L = Length of the conductor?

- Ans
- 1.  $F = \frac{B^2}{LI}$
  - 2.  $F = B^2LI$
  - 3.  $F = BI^2L$
  - 4.  $F = BIL$

Q.80 If the speed of a 3-phase, 400 V, 50 Hz synchronous motor is trebled, the efficiency of the machine will \_\_\_\_\_.

- Ans
- 1. reduce to one-third
  - 2. become 3 times
  - 3. remain constant
  - 4. become zero

Q.81 A combination of integral-cycle control and switching-instant control on the applied voltage wave is employed in IM for

- Ans
- 1. smooth speed control
  - 2. frequency control
  - 3. stator resistance control
  - 4. rotor resistance control only

Q.82 Which modulation technique is commonly used in power modulators to achieve variable power output?

- Ans
- 1. Frequency modulation
  - 2. Pulse-width modulation
  - 3. Amplitude modulation
  - 4. Delta modulation

Q.83 Which of the following statements are INCORRECT about auxiliary motor starting in synchronous motors?

- A) The function of the auxiliary motor is to run the synchronous motor at a speed less than its synchronous speed.
- B) The rating of the auxiliary motor is much lower than that of the synchronous motor.
- C) This method is used only for loaded synchronous motors.
- D) Auxiliary motor starting is not a commonly used starting method in modern days.

- Ans
- 1. A, C and D
  - 2. A and C
  - 3. B and D
  - 4. A and D

Q.84 A battery source of 20 V when connected to a load of  $19\ \Omega$  draws a current of 1 A. What is the value of internal resistance of battery?

- Ans
- 1.  $2\ \Omega$
  - 2.  $39\ \Omega$
  - 3.  $0.5\ \Omega$
  - 4.  $1\ \Omega$

Q.85 A three-phase star-connected synchronous alternator of rating 22 kVA, 20 kV, 50 Hz has synchronous reactance of  $8\ \Omega$  per phase. The induced voltage per phase is 20 kV and the line terminal voltage is 15 kV. Find the 3-phase maximum power of the machine.

- Ans
- 1. 37.5 MW
  - 2. 211.5 MW
  - 3. 112.5 MW
  - 4. 121.5 MW

**Q.86** Which of the following statements are correct about the maintenance factor?  
 I) It is the ratio of illumination under normal working condition to the total lumen given out by the lamp.  
 II) It is the ratio of illumination under normal working condition to the illumination when the things are perfectly clean.  
 III) The accumulation of dust, dirt and smoke on the lamp decreases the maintenance factor.  
 IV) It is the ratio of illumination when the things are perfectly clean to the illumination under normal working condition.

- Ans
- 1. Statements I and III
  - 2. Statements II and III
  - 3. Only Statement II
  - 4. Statements III and IV

**Q.87** A Kaplan turbine is used for \_\_\_\_\_.

- Ans
- 1. high heads and low quantities of water
  - 2. low heads and low quantities of water
  - 3. low heads and large quantities of water
  - 4. high heads and large quantities of water

**Q.88** The equivalent electrical circuit of a solar PV cell has a \_\_\_\_\_.

- Ans
- 1. capacitor
  - 2. transistor
  - 3. diode
  - 4. inductor

**Q.89** The collector to the base bias configuration of a common emitter transistor implicitly employs:

- Ans
- 1. voltage shunt negative feedback
  - 2. current shunt negative feedback
  - 3. voltage series positive feedback
  - 4. current series negative feedback

**Q.90** In the circuit shown here, the 20 V source has an internal resistance of 1 Ω. While the current source is ideal, the value of current I is \_\_\_\_\_.

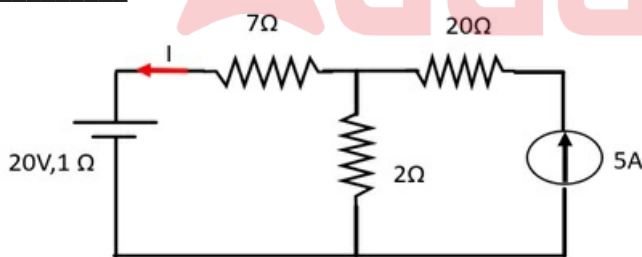

- Ans
- 1. 1 A
  - 2. 5 A
  - 3. 10 A
  - 4. -1 A

**Q.91** The operating point of a transistor known as \_\_\_\_\_.

- Ans
- 1. active point
  - 2. cut-off point
  - 3. quiescent point
  - 4. threshold point

Q.92 Which of the following represents the value of parameters A and D for a transmission line in end condenser method?

- Ans
- 1.  $A = 1 + YZ, D = 1$
  - 2.  $A = 1 - ZY; D = 1 + ZY$
  - 3.  $A = 1; D = 1 + ZY$
  - 4.  $A = 1 + ZY; D = 1 + ZY$

Q.93 In thermal power plant, the fire tube and water tube boilers are classified based on

- Ans
- 1. the combustion product formation
  - 2. steam formation rate
  - 3. state of fuel
  - 4. tubular heating surface

Q.94 The value of inductance needed to store 4kWh of energy in a coil carrying a 2000A current is:

- Ans
- 1.  $7.2 \times 10^6$  H
  - 2. 72 H
  - 3. 7.2 H
  - 4. 720 H

Q.95 If the value of the common base current gain ( $\alpha$ ) is 0.98, then the value of the common collector current gain ( $\gamma$ ) is \_\_\_\_\_.

- Ans
- 1. 98
  - 2. 50
  - 3. 49
  - 4. 0.02

Q.96 What is the advantage of using the current grading in relay systems?

- Ans
- 1. It reduces the impedance between two sub-stations.
  - 2. It overcomes the long time delays occurring in graded time lag systems.
  - 3. It ensures quick tripping of the faulty circuit.
  - 4. It improves the frequency stability of the power system.

Q.97 Which of the following statements is correct?

- Ans
- 1. The possibility of supply interruption due to lightning is more with underground cables.
  - 2. Fault can be easily located in underground cables.
  - 3. Overhead lines are more costly as compared to underground cables.
  - 4. The location of the fault in overhead lines can be found easily.

Q.98 Which of the following statements is/are NOT true for the damper windings in alternators?

- I) These are useful in preventing the hunting in alternators.
- II) Usually, damper windings are provided in smooth cylindrical type rotor alternators.
- III) Under normal working conditions, i.e., if machine is at synchronous speed, damper winding do not carry any currents.
- IV) Damper windings are also used to provide starting torque in alternators.

- Ans
- 1. III
  - 2. II
  - 3. I
  - 4. IV

Q.99 Which statement is NOT true for fixed drum type biogas power plant?

- Ans
- 1. The gas production per cubic metre of digester is less.
  - 2. It has a lower cost.
  - 3. It has constant pressure of biogas.
  - 4. It has no corrosion problem.

Q.100 In electromagnetism of parallel magnetic circuits, the reluctance offered for two parallel paths will be \_\_\_\_\_.

- Ans
- 1. cube for each path
  - 2. square for each path
  - 3. half for each path
  - 4. quarter for each path



## Junior Engineer Civil Mechanical and Electrical Examination 2024 Paper I

Exam Date	07/06/2024
Exam Time	1:00 PM - 3:00 PM
Subject	Junior Engineer 2024 Mechanical Paper I

### Section : General Intelligence and Reasoning

Q.1 How many triangles are there in the given figure?

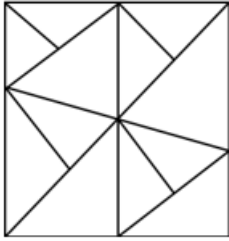

- Ans
- 1. 15
  - 2. 16
  - 3. 14
  - 4. 18

Q.2 In a certain code language, 'KNOT' is coded as '3618' and 'NOTE' is coded as '6438'. What is the code for 'E' in the given code language?

- Ans
- 1. 6
  - 2. 1
  - 3. 4
  - 4. 3

Q.3 Read the given statements and conclusions carefully. Assuming that the information given in the statements is true, even if it appears to be at variance with commonly known facts, decide which of the given conclusions logically follow(s) from the statements.

Statements: Some machines are shrugs. All machines are bins. No shrug is a cloth.

Conclusion (I): No cloth is a machine.

Conclusion (II): At least some shrugs are bins.

- Ans
- 1. Only conclusion (II) follows
  - 2. Only conclusion (I) follows
  - 3. Both conclusions (I) and (II) follow
  - 4. Neither conclusion (I) nor (II) follows

Q.4 What will come in the place of the question mark (?) in the following equation, if '+' and '-' are interchanged and 'x' and '÷' are interchanged?

$$61 - 45 \times 15 + 5 \div 9 = ?$$

- Ans
- 1. 4
  - 2. 14
  - 3. 19
  - 4. 9

Q.5 What should come in place of the question mark (?) in the given series based on the English alphabetical order?  
CEH, FHK, IKN, LNQ, ?

- Ans
- 1. OQT
  - 2. OQS
  - 3. PQS
  - 4. PQT



Q.6 Select the correct mirror image of the given figure when the mirror is placed at MN as shown below.

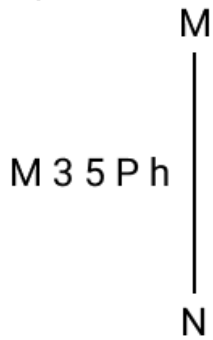

- Ans
- 1.  $h P 5 3 M$
  - 2.  $M 3 2 P h$
  - 3.  $h P 5 3 M$
  - 4.  $M 3 2 P h$

Q.7 Anil starts from point A and drives 7 km towards the east. He then takes a left turn, drives 3 km, turns left, and drives 9 km. He then takes a right turn and drives 3 km. He takes a final right turn, drives 2 km, and stops at point P. How far (shortest distance) and towards which direction should he drive in order to reach point A again? (All turns are  $90^\circ$  turns only, unless specified.)

- Ans
- 1. 8 km towards the east
  - 2. 6 km towards the south
  - 3. 9 km towards the east
  - 4. 6 km towards the west

Q.8 In a certain code language, 'CAFE' is coded as '3795' and 'FIND' is coded as '8634'. What is the code for 'F' in the given code language?

- Ans
- 1. 3
  - 2. 4
  - 3. 8
  - 4. 9

Q.9 What should come in place of '?' in the given series?  
147, 206, 124, 183, 101, 160, ?

- Ans
- 1. 40
  - 2. 56
  - 3. 78
  - 4. 61

Q.10 This question consists of a pair of words that have a certain relationship to each other. Select the pair that has the same relationship.

(The words must be considered as meaningful English words and must not be related to each other based on the number of letters/number of consonants/vowels in the word.)

Pressure : Pascal

- Ans
- 1. Electric Potential : Volt
  - 2. Sound : Watt
  - 3. Frequency : Ohm
  - 4. Force : Candela

Q.11 What will come in the place of the question mark (?) in the following equation, if '+' and '-' are interchanged and 'x' and '÷' are interchanged?

$$20 - 2 \div 4 \times 2 + 6 = ?$$

- Ans
- 1. 20
  - 2. 14
  - 3. 22
  - 4. 18

Q.12 In a certain code language,  
'A + B' means 'A is the mother of B',  
'A - B' means 'A is the brother of B',  
'A × B' means 'A is the husband of B',  
'A ÷ B' means 'A is the father of B'.  
How is Z related to V if 'Z ÷ X - C ÷ V × B + N'?

- Ans
- 1. Mother's father
  - 2. Father's father
  - 3. Brother
  - 4. Father

Q.13 PARK is related to QCUM in a certain way based on the English alphabetical order. In the same way, STOP is related to TVRR. To which of the following is RAMP related, following the same logic?

- Ans
- 1. TCQR
  - 2. SCPR
  - 3. SCQR
  - 4. TCPR

Q.14 What should come in place of the question mark (?) in the given series based on the English alphabetical order?  
AYH, BWJ, CUL, DSN, ?

- Ans
- 1. FPR
  - 2. EQP
  - 3. EQS
  - 4. EPL

Q.15 If A means +, B means -, C means × and D means ÷, then what will come in place of the question mark (?) in the following equation?

$$40 B 6 C 7 A 30 D 5 = ?$$

- Ans
- 1. 2
  - 2. 5
  - 3. 4
  - 4. 3

Q.16 CJHF and HOMK are related to each other in a certain way based on the English alphabetical order. In the same way, SZXV and XECA are related to each other. Which of the following is related to DLTR, following the same logic?

- Ans
- 1. KQYX
  - 2. IQYX
  - 3. KQYW
  - 4. IQYW

Q.17 Select the correct option that indicates the arrangement of the following words in a logical and meaningful order.

1. Eiffel Tower
2. Europe
3. Paris
4. Earth
5. France

Ans  1. 4, 1, 2, 5, 3  
 2. 4, 2, 5, 3, 1  
 3. 4, 5, 3, 1, 2  
 4. 4, 2, 1, 3, 5

Q.18 CF 9 is related to IL 21 in a certain way. In the same way, MP 29 is related to SV 41. To which of the following is KN 25 related, following the same logic?

Ans  1. LJ 18  
 2. GJ 18  
 3. QS 37  
 4. QT 37

Q.19 SPUR is related to WTYV in a certain way based on the English alphabetical order. In the same way, PMRO is related to TQVS. To which of the following is IFKH related, following the same logic?

Ans  1. MJLO  
 2. JMLO  
 3. MJOL  
 4. JMOL

Q.20 Select the pair in which the numbers are related to each other in the same way as are the numbers of the given pairs.

(NOTE: Operations should be performed on the whole numbers, without breaking down the numbers into its constituent digits. E.g. 13 – Operations on 13 such as adding/deleting/multiplying etc. to 13 can be performed. Breaking down 13 into 1 and 3 and then performing mathematical operations on 1 and 3 is not allowed.)  
(297, 466)  
(342, 511)

Ans  1. (116, 292)  
 2. (225, 394)  
 3. (194, 353)  
 4. (189, 348)

Q.21 Seven people - S, O, L, D, I, E, and R - are sitting around a circular table, facing the centre (not necessarily in the same order). O sits fourth to the left of E and R sits third to the right of O. L sits to the immediate left of R and to the immediate right of D. S sits second to the right of R.  
Who are the immediate neighbours of I?

Ans  1. O and L  
 2. S and E  
 3. O and D  
 4. S and O

Q.22 What should come in place of the question mark (?) in the given series?

115, 91, 70, 52, 37, ?

- Ans
- 1. 23
  - 2. 21
  - 3. 27
  - 4. 25

Q.23 Select the option in which the given figure is embedded (rotation is NOT allowed).

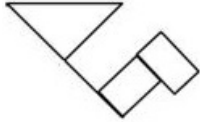

Ans

- 1.
- 2.
- 3.
- 4.

Q.24 Suresh starts from his home and drives 5 km towards the south. He then takes a left turn, drives 6 km, turns left, and drives 9 km. He then takes a left turn and drives 3 km and turns left, then drives 7 km to reach his office.

In which direction is the office with respect to his home?  
(All turns are 90° turns only, unless specified.)

- Ans
- 1. North-west
  - 2. North-east
  - 3. South-east
  - 4. West

Q25 What should come in place of ? in the given series based on the English alphabetical order?  
BLH, EKF, HJD, KIB, ?

- Ans
- 1. MFX
  - 2. OGY
  - 3. MEX
  - 4. NHZ

Q26 Select the option in which the numbers share the same relationship as that shared by the given pairs of numbers.

5 : 101

10 : 201

(NOTE: Operations should be performed on the whole number, without breaking down the numbers into its constituent digits. E.g. 13- Operations on 13 such as adding/subtracting/multiplying etc. to 13 can be performed. Breaking down 13 into 1 and 3 and then performing mathematical operations on 1 and 3 is NOT allowed.)

- Ans
- 1. 8 : 140
  - 2. 7 : 50
  - 3. 6 : 121
  - 4. 6 : 120

Q27 Select the set in which the numbers are related in the same way as are the numbers of the following sets.

(NOTE: Operations should be performed on the whole numbers, without breaking down the numbers into its constituent digits. E.g. 13 – Operations on 13 such as adding/subtracting/multiplying etc. to 13 can be performed. Breaking down 13 into 1 and 3 and then performing mathematical operations on 1 and 3 is not allowed.)

(17, 68, 8)

(16, 72, 9)

- Ans
- 1. (13, 78, 5)
  - 2. (10, 105, 21)
  - 3. (25, 140, 12)
  - 4. (11, 109, 13)

Q28 6 is related to 76 following a certain logic. Following the same logic, 8 is related to 102. To which of the following is 15 related following the same logic?

(NOTE: Operations should be performed on the whole numbers, without breaking down the numbers into their constituent digits. E.g. 13 – Operations on 13 such as adding / subtracting /multiplying to 13 can be performed. Breaking down 13 into 1 and 3 and then performing mathematical operations on 1 and 3 is not allowed.)

- Ans
- 1. 198
  - 2. 193
  - 3. 190
  - 4. 197

Q29 In a certain code language,

'A + B' means 'A is the brother of B',

'A – B' means 'A is the husband of B',

'A × B' means 'A is the sister of B' and

'A ÷ B' means 'A is the mother of B'.

How is B related to T if 'B + D – G ÷ P × T'?

- Ans
- 1. Father's brother
  - 2. Sister
  - 3. Mother's brother
  - 4. Sister's daughter

Q.30 What should come in place of the question mark (?) in the given series?

23, 26, 31, 38, 49, ?

Ans  1. 59

2. 62

3. 60

4. 61

Q.31 The position of how many letters will remain unchanged if each of the letters in the word 'SALIENT' is arranged in the English alphabetical order?

Ans  1. Four

2. One

3. Two

4. Three

Q.32 Select the figure from the options that can replace the question mark (?) and complete the given pattern.

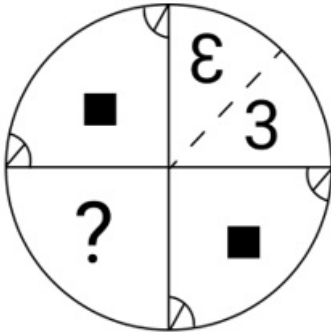

Ans

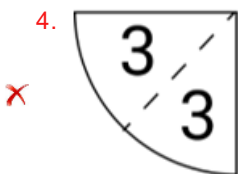
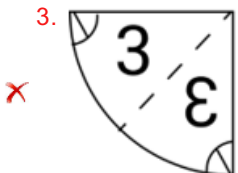
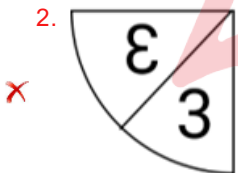
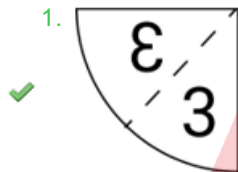

Q.33 What will come in place of the question mark (?) in the following equation if '+' and '÷' are interchanged and 'x' and '-' are interchanged?

$$84 + 12 \times 9 \div 13 - 21 = ?$$

- Ans
- 1. 271
  - 2. 259
  - 3. 264
  - 4. 273

Q.34 What should come in place of the question mark (?) in the given series based on the English alphabetical order?  
SJF, NEA, IZV, DUQ, ?

- Ans
- 1. XPL
  - 2. XPM
  - 3. YQL
  - 4. YPL

Q.35 In a certain code language, 'CARE' is coded as '3195' and 'HARE' is coded as '9341'.  
What is the code for 'H' in that language?

- Ans
- 1. 5
  - 2. 9
  - 3. 1
  - 4. 4

Q.36 What should come in place of the question mark (?) in the given series based on the English alphabetical order?  
DMU, HQY, LUC, PYG, TCK, ?

- Ans
- 1. YHL
  - 2. XGO
  - 3. TDL
  - 4. UBI

The logo for Adda247, featuring a large stylized 'A' above the text 'Adda247' in a bold, sans-serif font. The '247' is enclosed in a rectangular box.

Q.37 Select the option figure that will replace the question mark (?) in the figure given below to complete the pattern.

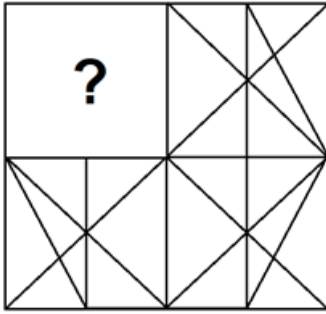

Ans

1.
2.
3.
4.

Q.38 Read the given statements and conclusions carefully. Assuming that the information given in the statements is true, even if it appears to be at variance with commonly known facts, decide which of the given conclusions logically follow(s) from the statements.

Statements: All roads are speed-breakers. No speed-breaker is a home.

Conclusion 1: Some roads are homes.

Conclusion 2: Some homes are speed-breakers.

- Ans
1. Both conclusion (1) and conclusion (2) follow
  2. Only conclusion (2) follows
  3. Only conclusion (1) follows
  4. None of the conclusions follow

Q.39 What should come in place of the question mark (?) in the given series based on the English alphabetical order?

FLOY, JPSC, NTWG, RXAK, ?

- Ans
1. VBG T
  2. VBEO
  3. VOED
  4. VOBE



Q.40 Select the option in which the given figure is embedded (rotation is NOT allowed).

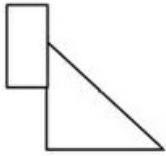

Ans

1.

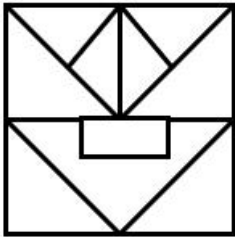

✗

2.

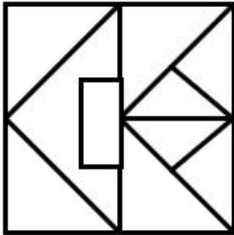

✓

3.

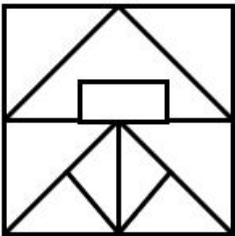

✗

4.

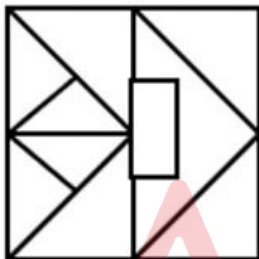

✗

Q.41 Six friends Abby, Bunny, Chan, Dolly, Emma and Fanny have different weights. Dolly's weight is an odd number. Dolly is heavier than Emma but not the heaviest. Chan is heavier than Fanny but lighter than Dolly. Chan is not heavier than Emma but is heavier than Fanny and Abby. Abby's weight is not an odd number. The lightest weight is 45 kilograms and the heaviest weight is 80 kilograms.

If Chan weighs 68 kilograms, which of the following can be the possible weight of Dolly (in kilograms)?

Ans

✓ 1. 71

✗ 2. 72

✗ 3. 66

✗ 4. 65

Q.42 Q, R, S, T, U, and V are sitting around a circular table, facing the centre (not necessarily in the same order) . S sits second to the left of R. Q sits third to the right of S. T is not an immediate neighbour of S. U sits to the immediate left of S.  
How many people are sitting between U and R when counted from the right of R?

- Ans
- 1. One
  - 2. Zero
  - 3. Two
  - 4. Three

Q.43 Select the option in which the given figure is embedded (rotation is NOT allowed).



Ans

- 1.
- 2.
- 3.
- 4.

Q.44 JNHF is related to MQKI in a certain way based on the English alphabetical order. In the same way, HLF D is related to KOIG. To which of the following is FJDB related, following the same logic?

- Ans
- 1. IMGE
  - 2. IMEG
  - 3. MIGE
  - 4. MIEG

Q.45 843 is related to 732 following a certain logic. Following the same logic, 632 is related to 521. To which of the following is 357 related following the same logic?

(NOTE: Operations should be performed on the whole numbers, without breaking down the numbers into its constituent digits. E.g. 13 – Operations on 13 such as adding /subtracting /multiplying etc. to 13 can be performed. Breaking down 13 into 1 and 3 and then performing mathematical operations on 1 and 3 is not allowed.)

- Ans
- 1. 240
  - 2. 246
  - 3. 340
  - 4. 346

Q.46 In a certain code language, 'MADE' is coded as '3517' and 'DOGS' is coded as '2458'. What is the code for 'D' in the given language?

- Ans
- 1. 1
  - 2. 5
  - 3. 4
  - 4. 2

Q.47 Select the correct option that indicates the arrangement of the following words in a logical and meaningful order.

1. Elderly
2. Adolescent
3. Infant
4. Adult
5. Baby

- Ans
- 1. 3, 5, 2, 4, 1
  - 2. 3, 5, 1, 4, 2
  - 3. 4, 5, 1, 3, 2
  - 4. 1, 5, 2, 3, 4

Q.48 'AC 2' is related to 'DF 8' in a certain way based on the English alphabetical and numerical order. In the same way, 'IK 5' is related to 'LN 125'. To which of the following is 'QS 7' related following the same logic?

- Ans
- 1. TU 343
  - 2. SY 343
  - 3. SU 343
  - 4. TV 343

Q.49 Select the set in which the numbers are related in the same way as are the numbers of the following sets.

(NOTE: Operations should be performed on the whole numbers, without breaking down the numbers into its constituent digits. E.g. 13 – Operations on 13 such as adding/subtracting/multiplying etc. to 13 can be performed. Breaking down 13 into 1 and 3 and then performing mathematical operations on 1 and 3 is not allowed.)

(47, 1, 23)  
(58, 4, 27)

- Ans
- 1. (64, 5, 12)
  - 2. (36, 30, 5)
  - 3. (74, 18, 28)
  - 4. (50, 14, 16)

Q.50 The position(s) of how many letters will remain unchanged if each of the letters in the word 'BLANKET' is arranged in alphabetical order?

- Ans
- 1. Three
  - 2. One
  - 3. Zero
  - 4. Two

Section : General Awareness

Q.1 According to the Census 2011 of India, arrange the following metropolitan cities on the basis of population in ascending order?  
A. Delhi  
B. Mumbai  
C. Kolkata

- Ans
- 1. B, C, A
  - 2. C, A, B
  - 3. A, B, C
  - 4. B, A, C

Q.2 If the government decides to privatise a major public sector industry, what might be an unintended consequence?

- Ans
- 1. Enhancement of operational efficiency
  - 2. Immediate increase in public revenue
  - 3. Reduction in corruption
  - 4. Potential monopolistic practices

Q.3 The first Anglo-Afghan war took place between 1838 - \_\_\_\_\_ .

- Ans
- 1. 1840
  - 2. 1842
  - 3. 1844
  - 4. 1841

Q.4 All the living and non-living things in a particular area constitute the \_\_\_\_\_ of the area.

- Ans
- 1. Species
  - 2. Life Circle
  - 3. Food Web
  - 4. Ecosystem

Q.5 What is the medical term for high blood pressure?

- Ans
- 1. Hypotension
  - 2. Hypertension
  - 3. Hyperglycemia
  - 4. Hypoglycemia

Q.6 Calcium hydroxide is the chemical name of which of the following saturated aqueous solutions?

- Ans
- 1. Hard water
  - 2. Black Water
  - 3. Limewater
  - 4. Carbonated water

Q.7 Which minister was in the news to launch the country's first crash testing programme 'Bharat NCAP', on 22 August 2023?

- Ans
- 1. Nitin Gadkari
  - 2. Raj Nath Singh
  - 3. Amit Shah
  - 4. Ashwini Vaishnaw

Q.8 In September 2023, Skill India Mission introduced a scheme that aims to spread awareness at grass root level about free skill training programmes for youth through robust skill training. What is the name of that scheme?

- Ans
- 1. Skills on the Go
  - 2. Skills on Wheels
  - 3. Skills on the Move
  - 4. Skill Bus

Q.9 How does the formation of igneous rocks occur?

- Ans
- 1. Formation through compression
  - 2. Formation through volcanic activity
  - 3. Formation through weathering
  - 4. Formation through sedimentation

Q.10 The National Waterway (NW) – 3 is located in which of the following states?

- Ans
- 1. Maharashtra
  - 2. Andhra Pradesh
  - 3. Gujarat
  - 4. Kerala

Q.11 Who among the following eminent musicians was born in Bihar?

- Ans
- 1. Ustad Zakir Hussain
  - 2. Ustad Bismillah Khan
  - 3. Pandit Shivkumar Sharma
  - 4. Pandit Ravi Shankar

Q.12 How many fundamental duties of citizens have been enumerated by the 42nd Amendment of the Constitution, adopted in 1976?

- Ans
- 1. 9
  - 2. 10
  - 3. 11
  - 4. 13

Q.13 Who is the writer of Indian president's biography 'Droupadi Murmu : From Tribal Hinterlands to Raisina Hill'?

- Ans
- 1. Kamala Surayya
  - 2. Kasturi Ray
  - 3. Phoolan Devi
  - 4. Mary Kom

Q.14 Which part of the cell is responsible for generating the primary energy molecule ATP in eukaryotic animals?

- Ans
- 1. Vacuoles
  - 2. Cell wall
  - 3. Endoplasmic reticulum
  - 4. Mitochondria

Q.15 'Ama Odisha Nabin Odisha' scheme was implemented by which department in July 2023 by Odisha Government?

- Ans
- 1. Health and Family Welfare Department
  - 2. Housing and Urban Development
  - 3. Panchayati Raj and Drinking Water Department
  - 4. General Administration Department

Q.16 The Palamu plateau is located in which of the following states?

- Ans
- 1. Tripura
  - 2. Karnataka
  - 3. Jharkhand
  - 4. Telangana

Q.17 On 26 July 2023, Tenzing Yangki created history in Arunachal Pradesh by achieving a prestigious UPSC rank and becoming the state's first female \_\_\_\_\_.

- Ans
- 1. Indian Administrative Service Officer
  - 2. India Police Service Officer
  - 3. Education Commissioner
  - 4. Revenue Officer

Q.18 Rama experiences a drop in temperature as she is getting higher and higher in the mountains while trekking. What could be the cause of this?

- Ans
- 1. Rama's fatigue
  - 2. Lower air pressure at altitude
  - 3. Higher air pressure at altitude
  - 4. Less water

Q.19 What is the function of the endoplasmic reticulum (ER)?

- Ans
- 1. Protein synthesis
  - 2. Lipid synthesis and detoxification
  - 3. DNA replication
  - 4. Energy production

Q.20 Select the correct arrangement of the parts of the food canal in humans from the starting point to the ending point.

- Ans
- 1. The buccal cavity ---> Oesophagus ---> Stomach ---> Large intestine ---> Small intestine ---> Rectum ---> Anus
  - 2. The buccal cavity ---> Oesophagus ---> Stomach ---> Small intestine ---> Large intestine ---> Anus ---> Rectum
  - 3. The buccal cavity ---> Oesophagus ---> Stomach ---> Large intestine ---> Small intestine ---> Anus ---> Rectum
  - 4. The buccal cavity ---> Oesophagus ---> Stomach ---> Small intestine ---> Large intestine ---> Rectum ---> Anus

Q.21 When and where was the Veda Samaj, inspired by the Brahmo Samaj, established?

- Ans
- 1. Bombay 1867
  - 2. Madras 1864
  - 3. Calcutta 1830
  - 4. Lahore 1875

Q.22 In 2010, in which Indian state did the crisis of microfinance happen?

- Ans
- 1. Karnataka
  - 2. Tamil Nadu
  - 3. Andhra Pradesh
  - 4. Maharashtra

Q.23 Which of the following set of Articles of the Indian Constitution guarantees different types of freedoms to its citizens?

- Ans
- 1. Articles 14 – 19
  - 2. Articles 19 – 22
  - 3. Articles 25 – 30
  - 4. Articles 32 – 35

Q.24 Which of the following is NOT a major river basin in India?

- Ans
- 1. Tapi
  - 2. Krishna
  - 3. Narmada
  - 4. Kalindi

Q.25 5 stones were dropped from the top of a building. They all fell to the ground in straight lines. What can be said about their motion?

- Ans
- 1. They had rectilinear motion
  - 2. They had curvilinear motion
  - 3. They had slow motion
  - 4. They had gravity free motion

Q.26 What is the full form of GST?

- Ans
- 1. Gifts and Sale Tax
  - 2. Goods and Services Tax
  - 3. Goods and Sale Tax
  - 4. Gifts and Services Tax

Q.27 For strengthening the fundamental duties, the Verma Committee identified a few existing acts by which a proper implementation of such duties can be accomplished. Which of the following was NOT referred by him?

- Ans
- 1. Representation of People Act, 1951
  - 2. Protection of Civil Rights Act, 1955
  - 3. Unlawful Activities Protection Act, 1967
  - 4. Wildlife Segregation Act, 1970

Q.28 Food rich in carbohydrates (like potatoes) and those rich in fats (like butter) are also known as \_\_\_\_\_.

- Ans
- 1. Energy-Giving Food
  - 2. Main Course
  - 3. Unsafe Food
  - 4. Fast Food

Q.29 Sometimes when heated, solid changes into liquid at normal atmospheric pressure on reaching its melting point. What is the name of the amount of heat required?

- Ans
- 1. Latent heat of diffusion
  - 2. Latent heat of fusion
  - 3. Latent melting point
  - 4. Latent change of state point

Q.30 In which city is the Arun Jaitley Stadium located?

- Ans
- 1. New Delhi
  - 2. Punjab
  - 3. Mumbai
  - 4. Chennai

Q.31 Which Indian state passed the Right to Health (RTH) bill, which guarantees access to equitable healthcare services for all patients in March 2023?

- Ans
- 1. Maharashtra
  - 2. Gujarat
  - 3. Tamil Nadu
  - 4. Rajasthan

Q.32 What balances the atmospheric pressure with equal force so that animals do not crumble under the high pressure exerted on them by the atmosphere?

- Ans
- 1. Moon's gravitational pull
  - 2. Pressure because of sunlight
  - 3. Energy produced by the food consumed
  - 4. Blood Pressure

Q.33 In 1527, battle of Khanwa fought between Babur and ruler of Mewar

- Ans
- 1. Rana Sanga
  - 2. Prithviraj
  - 3. Rana Pratap
  - 4. Rana Mewari

Q.34 Which type of cell lacks a membrane-bound nucleus?

- Ans
- 1. Prokaryotic cell
  - 2. Eukaryotic cell
  - 3. Animal cell
  - 4. Plant cell

Q.35 Which of the following is NOT one of the five outlined pillars of Atmanirbhar Bharat?

- Ans
- 1. Economy
  - 2. Infrastructure
  - 3. Demand
  - 4. Resilience

Q.36 The concept of 'Standard Urban Area (SUA)' was introduced in which census of India?

- Ans
- 1. Census 1971
  - 2. Census 1961
  - 3. Census 1951
  - 4. Census 1981

Q.37 Why is there a need to encourage Indian farmers to switch to sustainable crops / farming systems?

- Ans
- 1. To increase upfront costs
  - 2. To meet the current calorie needs of the population
  - 3. To address environmental damage and degradation of ecosystem services
  - 4. To reduce the use of technology in agriculture



Q.38 A nonstop train moving on a straight track with a uniform acceleration passed station A at a velocity of 'u' and reached the next station B at a velocity of '5u'. Its average velocity between the given stations is:

- Ans
- 1.  $2u$
  - 2.  $2.5u$
  - 3.  $3u$
  - 4.  $4u$

Q.39 If 'G', 'M' and 'R' represent the universal gravitation constant, mass of the earth and radius of the earth, respectively, then which of the following is the correct expression for the acceleration due to gravity (g) on the surface of the earth?

- Ans
- 1.  $GM^2/R$
  - 2.  $GM/R^2$
  - 3.  $GM/R$
  - 4.  $GMR^2$

Q.40 What are 'Bullets' in Microsoft Word?

- Ans
- 1. Characters used for decoration
  - 2. Small dots, squares, dashes, or graphics preceding text
  - 3. Large circles indicating importance
  - 4. Highlighted text

Q.41 In which year did Louis Pasteur discover that yeast is responsible for producing alcohol from sugar?

- Ans
- 1. 1830
  - 2. 1857
  - 3. 1891
  - 4. 1904

Q.42 The equipment used to record the intensity of an earthquake is

- Ans
- 1. barometer
  - 2. pyrometer
  - 3. seismograph
  - 4. calorimeter

Q.43 Which of the following is a shortcut key to undo the last action in many word processors?

- Ans
- 1. Ctrl + Z
  - 2. Ctrl + X
  - 3. Ctrl + C
  - 4. Ctrl + V

Q.44 According to the census of India 2011, which of the following states has the highest density of population per square kilometre?

- Ans
- 1. Uttar Pradesh
  - 2. Maharashtra
  - 3. West Bengal
  - 4. Odisha

Q.45 Through which of the following body parts does food need to pass before reaching the intestines?

- Ans
- 1. Windpipe --> Food pipe
  - 2. Mouth --> Rectum
  - 3. Oesophagus --> Stomach
  - 4. Stomach --> Rectum

Q.46 Which of the following states has the largest legislative assembly (in terms of number of members) in the country as on 30th September 2023?

- Ans
- 1. Rajasthan
  - 2. Tamil Nadu
  - 3. Madhya Pradesh
  - 4. Uttar Pradesh

Q.47 Which white powder, ubiquitous in modern kitchens, combines with acid to produce carbon dioxide?

- Ans
- 1. Sodium phosphate
  - 2. Sodium fluoride
  - 3. Sodium nitrate
  - 4. Sodium bicarbonate

Q.48 Which of the following Hindustani ragas corresponds to the 'Mohanam Ragam' of Carnatic music?

- Ans
- 1. Bhoop
  - 2. Bagkauns
  - 3. Aadi
  - 4. Zilla

Q.49 Who among the following was one of the co-founders of the Swaraj Party within the Congress to argue for a return to council politics?

- Ans
- 1. Rabindranath Tagore
  - 2. Chittaranjan Das
  - 3. Gopal Krishna Gokhale
  - 4. Mahatma Gandhi

Q.50 Karnam Malleshwari won a bronze medal at which Olympic games?

- Ans
- 1. 2000 Sydney
  - 2. 2004 Athens
  - 3. 2008 Beijing
  - 4. 2012 London

Section : General Engineering Mechanical

Q.1 The boiling point of refrigerant R-13 is \_\_\_\_\_.

- Ans
- 1. -107.7°C
  - 2. -81.4°C
  - 3. +86.6°C
  - 4. - 157.5°C

Q.2 For ammonia refrigerating systems, the tubes of a shell and tube condenser are made of \_\_\_\_\_.

- Ans
- 1. copper
  - 2. steel
  - 3. aluminium
  - 4. brass

Q.3 In a single stationary blade type rotary compressor, a blade is set into the slot of a cylinder in such a manner that it always maintains contact with the roller by means of:

- Ans
- 1. spring
  - 2. cam and follower
  - 3. centrifugal force
  - 4. gravity

Q.4 Which of the following statements is true about the Carnot cycle?

- Ans
- 1. It is a reversible cycle.
  - 2. The efficiency of the Carnot cycle is always less than that of any other heat engine operating between the same two temperatures.
  - 3. Its efficiency depends only on the pressure difference between the two reservoirs.
  - 4. It involves only two reversible isothermal processes.

Q.5 Which part of the lathe has a long shaft with the keyway extending from the feed box across and in front of the bed?

- Ans
- 1. Feed rod
  - 2. Lead screw
  - 3. Headstock spindle
  - 4. Sliding gear shaft

Q.6 Which of the following is NOT a function of lubricating oils used in refrigerants?

- Ans
- 1. Sealing the gas between the suction and discharge ports
  - 2. Decreasing the coolant temperature and hence increasing COP
  - 3. Minimising friction
  - 4. Transferring heat from the crank-case to the compressor

Q.7 Which of the following is the chemical formula of hydro-carbon refrigerant R-170?

- Ans
- 1.  $C_3H_6$
  - 2.  $C_3H_8$
  - 3.  $C_2H_6$
  - 4.  $C_4H_{10}$

Q.8 Which of the following statements is INCORRECT about the friction factor of Darcy's equation?

- Ans
- 1. The value of friction factor depends on the Reynolds number of the flow.
  - 2. The value of friction factor depends on the roughness condition of the pipe surface.
  - 3. Friction factor is a dimensionless quantity.
  - 4. Friction factor value is same for all the flow conditions.

Q.9 For a winter air-conditioning system, relative humidity should NOT be more than:

- Ans
- 1. 90%
  - 2. 75%
  - 3. 60%
  - 4. 40%

Q.10 In an open channel flow, which device increases the enthalpy of gas using external work transfer?

- Ans
- 1. Turbine
  - 2. Compressor
  - 3. Motor
  - 4. Boiler

Q.11 If  $\eta_{gs}$  is gross stage efficiency;  $\eta_b$  is blade efficiency and  $\eta_n$  is nozzle efficiency of a steam turbine, then which of the following relations is correct?

- Ans
- 1.  $\eta_{gs} = \frac{\eta_n}{\eta_b}$
  - 2.  $\eta_{gs} = \eta_b$
  - 3.  $\eta_{gs} = \frac{\eta_b}{\eta_n}$
  - 4.  $\eta_{gs} = \eta_b \times \eta_n$

Q.12 Which of the following assertions holds true when a constant volume of gas is heated?

- Ans
- 1. The change in enthalpy of the gas is zero
  - 2. The temperature of the gas remains constant
  - 3. The work done by the gas is a finite value
  - 4. The heat added to the gas is equal to the change in internal energy

Q.13 The right limb of a simple manometer containing mercury is open to atmosphere. The left limb is connected to a pipe in which a fluid of specific gravity 0.9 is flowing. The centre of the pipe is 12 cm below the level of mercury in the right limb. The difference of mercury level in the two limbs is 20 cm. What is the pressure of fluid in the pipe (take  $g = 10 \text{ m/s}^2$ )?

- Ans
- 1. 26480 N/m<sup>2</sup>
  - 2. 720 N/m<sup>2</sup>
  - 3. 27920 N/m<sup>2</sup>
  - 4. 27200 N/m<sup>2</sup>

Q.14 Which of the following statements is INCORRECT about the steam separator in a steam boiler?

- Ans
- 1. In the steam separator, water separates out from steam due to its greater inertia.
  - 2. Steam separator is also known as steam drier.
  - 3. In the steam separator, steam is made to change its direction of flow.
  - 4. Steam separator is provided to collect the water resulting from partial condensation of steam.

Q.15 In the P-H diagram of the vapour compression cycle, the compression process is shown by a/an \_\_\_\_\_.

- Ans
- 1. inclined straight line with a negative slope
  - 2. vertical line
  - 3. curved line
  - 4. inclined straight line with a positive slope

Q.16 Which of the following are fire tube boilers?

- Ans
- 1. Benson boilers
  - 2. Loeffler boilers
  - 3. Scotch-marine boilers
  - 4. Stirling boilers

Q.17 In case of two-stroke petrol engines, if exhaust gases do NOT leave the cylinder, then:

- Ans
- 1. fresh charge gets diluted and efficiency of the engine increases
  - 2. fresh charge gets diluted and efficiency of the engine decreases
  - 3. fresh charge gets diluted and efficiency of the engine remains unchanged
  - 4. fresh charge gets diluted and performance of the engine increases

Q.18 For the given overall heat transfer coefficient and temperature difference, if the area of evaporator surface increases, then the capacity of evaporator:

- Ans
- 1. can increase or decrease
  - 2. remains constant
  - 3. decreases
  - 4. increases

Q.19 Which of the following is an advantage of multistage reciprocating air compressor?

- Ans
- 1. Lubrication improved due to lower temperature
  - 2. Volumetric efficiency increases for the same pressure ratio
  - 3. Less expensive with longer life
  - 4. Chance of leakage loss is low

Q.20 Which of the following statements is INCORRECT about the Cochran boiler?

- Ans
- 1. The Cochran boiler is a vertical boiler.
  - 2. The Cochran boiler is a multi-tubular boiler.
  - 3. The Cochran boiler is an externally fired boiler.
  - 4. The Cochran boiler is a natural circulation type boiler.

Q.21 The continuous injection system usually has a \_\_\_\_\_.

- Ans
- 1. rotary pump
  - 2. vane pump
  - 3. gear pump
  - 4. plunger pump

Q.22 Which of the following equations is based on the fact that the mass flow rate at any section remains constant?

- Ans
- 1. Continuity equation
  - 2. Momentum equation
  - 3. Steady flow energy equation
  - 4. Bernoulli's equation

Q.23 A system undergoes a process in which it absorbs 500 J of heat and does 250 J of work. What is the change in the internal energy of the system?

- Ans
- 1. 250 J
  - 2. -250 J
  - 3. 750 J
  - 4. -750 J

Q.24 What is the order of temperature generated at the anode during arc generation in electric arc welding?

- Ans
- 1. 3500°C
  - 2. 4500°C
  - 3. 6000°C
  - 4. 2000°C

Q.25 Which of the following forced convection evaporator units have a discharge air rate from 60 m/min to 90 m/min?

- Ans
- 1. Frosting evaporators
  - 2. Low velocity cooling forced convection evaporators
  - 3. High velocity cooling forced convection evaporators
  - 4. Defrosting evaporators

Q.26 For which of the following fluids is the rate of deformation proportional to the shear stress?

- Ans
- 1. Milk
  - 2. Blood
  - 3. Rice starch
  - 4. Gasoline

Q.27 Which shielding gas is commonly used in TIG welding?

- Ans
- 1. Argon
  - 2. Hydrogen
  - 3. Oxygen
  - 4. Carbon dioxide

Q.28 When a system expands freely against vacuum, then work transfer involved is:

- Ans
- 1. negative
  - 2. either positive or negative
  - 3. positive
  - 4. zero

Q.29 Which of the following types of steam nozzle is suitable for use when the inlet steam velocity is very low and the outlet steam velocity is desired to be supersonic?

- Ans
- 1. Convergent-divergent nozzle
  - 2. Divergent nozzle
  - 3. Convergent nozzle
  - 4. Divergent-convergent nozzle

Q.30 When a body is immersed in a fluid, upward force exerted by the fluid is equal to the \_\_\_\_\_.

- Ans
- 1. density of the Body
  - 2. weight of the fluid displaced by the body
  - 3. volume of water displaced by the body
  - 4. weight of the body

Q.31 In case of a flat pivot bearing, which of the following options is correct about the sliding friction?

- Ans
- 1. The sliding friction consideration is along the flat surface of contact between the pivot and the shaft.
  - 2. There is no sliding friction between the pivot and the shaft.
  - 3. The sliding friction consideration is along the length of the shaft which is inside the bearing.
  - 4. The sliding friction consideration is along the vertical curved surface of contact between the pivot and the shaft.

Q.32 The pressure at any point in a fluid at rest has the same magnitude in all the directions. This fact is known as \_\_\_\_\_ .

- Ans
- 1. the pressure law
  - 2. Bernoulli's law
  - 3. Newton's law
  - 4. Pascal's law

Q.33 The correct relationship between the coefficient of friction ( $\mu$ ) and the angle of friction ( $\phi$ ) is

- Ans
- 1.  $\mu = \sin \phi$
  - 2.  $\mu = \cot \phi$
  - 3.  $\mu = \tan \phi$
  - 4.  $\mu = \cos \phi$

Q.34 In the study of flow of fluid in pipes, total energy line is also known as \_\_\_\_\_ .

- Ans
- 1. energy gradient line
  - 2. hydraulic gradient line
  - 3. pressure line
  - 4. piezometric head line

Q.35 Mention the sequence of points that mild steel material undergoes failure by referring to the stress strain diagram.

- Ans
- 1. Elastic Deformation, Yielding, Strain Hardening, Necking, Fracture
  - 2. Yielding, Elastic Deformation, Strain Hardening, Necking, Fracture
  - 3. Yielding, Elastic Deformation, Necking, Strain Hardening, Fracture
  - 4. Elastic Deformation, Strain Hardening, Yielding, Necking, Fracture

Q.36 In which of the following turbines, the ends of the blades are welded to disks to form a cage like a hamster cage and instead of the bars, the turbine has the trough-shaped steel blades?

- Ans
- 1. Francis turbine
  - 2. Kaplan turbine
  - 3. Cross-flow turbine
  - 4. Pelton turbine

Q.37 Sulphur dioxide refrigerant can be designated as:

- Ans
- 1. R-744
  - 2. R-764
  - 3. R-727
  - 4. R-729

Q.38 Which of the following methods is NOT used for the leakage detection of CFC refrigerants?

- Ans
- 1. Soap solution
  - 2. Halide torch
  - 3. Burning candle
  - 4. Electronic leak detection device

Q.39 Which pressure indicates the difference between the atmospheric pressure and the absolute pressure?

- Ans
- 1. Local atmospheric pressure
  - 2. Gauge pressure
  - 3. Vacuum pressure
  - 4. System pressure

Q.40 \_\_\_\_\_ is the machining process that uses a saw blade to remove material from a workpiece.

- Ans
- 1. Filing
  - 2. Turning
  - 3. Sawing
  - 4. Drilling

Q.41 If 'u' is the velocity of the runner and 'V' is the velocity of the jet at inlet, what is the condition for the maximum hydraulic efficiency of a Pelton wheel?

- Ans
- 1.  $V = 3u$
  - 2.  $V = u/2$
  - 3.  $V = u$
  - 4.  $V = 2u$

Q.42 Chezy's equation is applicable for:

- Ans
- 1. transient internal flow
  - 2. steady internal flow
  - 3. transient open flow
  - 4. steady open flow

Q.43 Manometric efficiency of a centrifugal pump is defined as the \_\_\_\_\_.

- Ans
- 1. ratio of the actual discharge to the theoretical discharge
  - 2. difference of the manometric head and the static head
  - 3. ratio of the power available at the impeller to the power at the shaft
  - 4. ratio of the manometric head to the head imparted by the impeller

Q.44 Which of the following statements is INCORRECT about atmospheric pressure?

- Ans
- 1. Atmospheric pressure varies with altitude.
  - 2. The atmospheric air exerts normal pressure upon all the surfaces in contact.
  - 3. Atmospheric pressure is also called barometric pressure.
  - 4. The equivalent value of atmospheric pressure is 10.3 cm of water.

Q.45 The boiling point of inorganic refrigerant R-744 is \_\_\_\_\_.

- Ans
- 1.  $+33.6^{\circ}\text{C}$
  - 2.  $-15.8^{\circ}\text{C}$
  - 3.  $-73.6^{\circ}\text{C}$
  - 4.  $+22.4^{\circ}\text{C}$



Q.46 Brake power involves determination of the:

- Ans
- 1. piston indicator
  - 2. inertia and displacement of the shaft
  - 3. pressure and piston displacement
  - 4. torque and angular speed of the shaft

Q.47 The ratio of the actual brake thermal efficiency obtained from an engine to the theoretical efficiency of the engine cycle is called:

- Ans
- 1. relative efficiency
  - 2. scavenging efficiency
  - 3. brake thermal efficiency
  - 4. combustion efficiency

Q.48 Coefficient of discharge ( $C_d$ ) of a flow-measuring device is defined as the \_\_\_\_\_.

- Ans
- 1. ratio of theoretical discharge to actual discharge
  - 2. ratio of actual discharge to theoretical discharge
  - 3. product of actual discharge and theoretical discharge
  - 4. product of cross-sectional area and velocity

Q.49 Determine the torsional rigidity of a hollow shaft of 200 mm external diameter and 150 mm internal diameter. Consider  $G = 90 \text{ GPa}$ .

- Ans
- 1.  $8.72 \times 10^{13} \text{ N-mm}^2$
  - 2.  $9.66 \times 10^{12} \text{ N-mm}^2$
  - 3.  $12.46 \times 10^{13} \text{ N-mm}^2$
  - 4.  $10.25 \times 10^{12} \text{ N-mm}^2$

Q.50 The condition of equilibrium states that a stationary body that is subjected to coplanar forces will be in equilibrium if the algebraic sum of all the \_\_\_\_\_ and the algebraic sum of \_\_\_\_\_ of all the external forces about any point in their plane is zero.

- Ans
- 1. internal forces; couple
  - 2. internal forces; moment
  - 3. external forces; moment
  - 4. external forces; couple

Q.51 The difference between the total head at the outlet of a centrifugal pump and the total head at the inlet of a centrifugal pump is called \_\_\_\_\_.

- Ans
- 1. static head
  - 2. suction head
  - 3. dynamic head
  - 4. manometric head

Q.52 The fully halogenated refrigerants with chlorine (Cl) atom in their molecules are referred to as:

- Ans
- 1. inorganic refrigerants
  - 2. hydro-carbon refrigerants
  - 3. CFC refrigerants
  - 4. HCFC refrigerants

Q.53 The ignition coil of an IC engine stores the energy in its \_\_\_\_\_.

- Ans
- 1. magnetic field
  - 2. resistor
  - 3. capacitor
  - 4. electric field

Q.54 The pressure, which is measured with reference to absolute vacuum pressure is called:

- Ans
- 1. atmospheric pressure
  - 2. absolute pressure
  - 3. vacuum pressure
  - 4. gauge pressure

Q.55 Which of the following statements is true for magneto ignition system?

- Ans
- 1. It is simpler in construction than coil ignition system.
  - 2. More frequent maintenance is required compared to coil ignition system.
  - 3. The efficiency of the system improves as the engine speed increases.
  - 4. Its intensity of spark is very good even at low speed.

Q.56 The data for an impulse steam turbine are given as follows.  
(i) Mean blade velocity = 400 m/s  
(ii) Absolute velocity of steam at the inlet to the moving blade = 1200 m/s  
(iii) Sum of velocities of whirl at the inlet and the outlet of the blade = 1500 m/s  
What will be the efficiency of the blade?

- Ans
- 1. 0.67
  - 2. 0.83
  - 3. 0.42
  - 4. 0.5

Q.57 Which of the following statements is correct about slotting process?

- Ans
- 1. The tool reciprocates vertically and the workpiece is fed into the cutting tool.
  - 2. Both, tool and workpiece can reciprocate according to the size of slotting machine and workpiece.
  - 3. The workpiece reciprocates horizontally and the tool is fed in.
  - 4. The tool reciprocates horizontally and the workpiece is fed into the cutting tool.

Q.58 The Zenith carburettor is a type of \_\_\_\_\_.

- Ans
- 1. constant-vacuum carburettor
  - 2. constant-choke carburettor
  - 3. multijet carburettor
  - 4. multiple-venturi carburettor

Q.59 In a vapour compression refrigeration system, the lowest temperature during the cycle is observed after:

- Ans
- 1. compression
  - 2. evaporation
  - 3. condensation
  - 4. expansion

Q.60 In case of a single stage centrifugal compressor, the compression ratio that an impeller can develop is limited to about:

- Ans
- 1. 4.5
  - 2. 3.0
  - 3. 3.5
  - 4. 4.0

Q.61 Calculate the minimum diameter of the shaft, such that the shearing stress does NOT exceed 50 N/mm<sup>2</sup> during torque transmission of 15000 N-m.

- Ans
- 1. 100.2 mm
  - 2. 120.6 mm
  - 3. 98.4 mm
  - 4. 115.2 mm

Q.62 Pump disassembling is NOT necessary in \_\_\_\_\_ .

- Ans
- 1. cannot be predicted
  - 2. closed impellers
  - 3. open impellers
  - 4. semi-open impellers

Q.63 The enthalpy of an open system \_\_\_\_\_.

- Ans
- 1. decreases as energy is added to the system
  - 2. remains constant
  - 3. is not a meaningful concept
  - 4. increases as energy is added to the system

Q.64 Which of the following is NOT a component of a hydroelectric power plant?

- Ans
- 1. Penstock
  - 2. Tailrace
  - 3. Condenser
  - 4. Surge tank

Q.65 Identify the operation of production of flat vertical surfaces on both sides of a workpiece by using two side milling cutters mounted on the same arbor.

- Ans
- 1. Face milling
  - 2. Straddle milling
  - 3. Gang milling
  - 4. Side milling

Q.66 The bearing surface provided at any position along the shaft (but not at the end of the shaft) to carry the axial thrust, is known as \_\_\_\_\_.

- Ans
- 1. collar
  - 2. flat bearing surface
  - 3. conical bearing surface
  - 4. truncated bearing surface

Q.67 Internal combustion engines have \_\_\_\_\_.

- Ans
- 1. high initial cost compared to external combustion engine
  - 2. lower thermal efficiency than external combustion engine
  - 3. higher thermal efficiency than external combustion engine
  - 4. low power to weight ratio compared to external combustion engine

Q.68 When there is a \_\_\_\_\_, work is transferred over the system boundary in an open system.

- Ans
- 1. change in the kinetic energy of the fluid
  - 2. change in the potential energy of the fluid
  - 3. difference in pressure between the system and surroundings
  - 4. difference in datum head between the system and surroundings

Q.69 \_\_\_\_\_ is a type of rolling process used in metalworking.

- Ans
- 1. Powder metallurgy
  - 2. Injection moulding
  - 3. Hydroforming
  - 4. Hot rolling

Q.70 Which of the following statements is correct in case of semi-open impeller?

- Ans
- 1. Both sides of the impeller vanes are covered with baseplates.
  - 2. One side of the impeller vanes is covered with a baseplate.
  - 3. Both sides of the impeller vanes are covered with crown plates.
  - 4. Impeller vanes are not covered with baseplates.

Q.71 If the indicated power and frictional power of an engine are 100 KW and 25 KW, respectively, then what will be the brake power of the engine?

- Ans
- 1. 50 KW
  - 2. 75 KW
  - 3. 62.5 KW
  - 4. 125 KW

Q.72 Which of the following statements is/are correct regarding Fire Tube Boilers?

- 1) In fire tube boilers, the hot gases are inside the tubes and water surrounds the tubes.
- 2) Cochran boiler is a type of fire tube boiler.
- 3) Stirling boiler is a type of fire tube boiler.

- Ans
- 1. Only 1
  - 2. 1 and 2
  - 3. 2 and 3
  - 4. 1 and 3

Q.73 In chemical machining, material is removed from the work piece by \_\_\_\_\_.

- Ans
- 1. chemical burning
  - 2. chemical evaporation
  - 3. erosion
  - 4. chemical dissolution

Q.74 Which of the following moulding techniques uses a sand and clay mixture as the mould material?

- Ans
- 1. Green sand moulding
  - 2. Shell moulding
  - 3. Die casting
  - 4. Investment casting

Q.75 The product of the area of the surface and the intensity of pressure at the centroid of the area is called \_\_\_\_\_.

- Ans
- 1. buoyant force
  - 2. viscous force
  - 3. pressure density
  - 4. total pressure

Q.76 In which of the following types of draught is air forced into the boiler under pressure by a fan?

- Ans
- 1. Induced draught
  - 2. Forced draught
  - 3. Natural draught
  - 4. Steam jet draught

Q.77 Which of the following types of cast iron is the hardest among all?

- Ans
- 1. Ductile cast iron
  - 2. Brittle cast iron
  - 3. White cast iron
  - 4. Gray cast iron

Q.78 Which of the following statements is INCORRECT about the high-pressure and low-water safety alarm in a steam boiler?

- Ans
- 1. The high-pressure and low-water safety alarm operates with loud noise.
  - 2. The high-pressure and low-water safety alarm is suitable for a locomotive boiler.
  - 3. The high-pressure and low-water safety alarm has two valves.
  - 4. The high-pressure and low-water safety alarm is a safety mounting against high pressure and low water levels.

Q.79 Vertical depth of any point below the free surface in a liquid at rest is known as \_\_\_\_\_.

- Ans
- 1. pressure head
  - 2. velocity head
  - 3. datum head
  - 4. total head

Q.80 The value of specific gravity of mercury is \_\_\_\_\_.

- Ans
- 1. 1.36
  - 2. 13.6
  - 3. 0.0012
  - 4. 0.136

Q.81 Which of the following is the condition of the maximum discharge of flue gases through a chimney in a steam boiler?

- Ans
- 1. The maximum discharge of flue gases through a chimney does not depend on the temperature of flue gases in the steam boiler.
  - 2. The temperature of flue gases is slightly greater than twice the atmospheric temperature in Kelvin units.
  - 3. The temperature of flue gases is exactly equal to twice the atmospheric temperature in Kelvin units.
  - 4. The temperature of flue gases is equal to the atmospheric temperature in Kelvin units.

Q.82 At absolute zero temperature ( $T = 0K$ ), the specific enthalpy of an ideal gas is:

- Ans
- 1. 1
  - 2. infinite
  - 3. 0
  - 4.  $<0$

Q.83 Free expansion process is \_\_\_\_\_.

- Ans
- 1. sometimes reversible and sometimes irreversible
  - 2. a reversible process
  - 3. an irreversible process
  - 4. initially it is reversible and later it become irreversible

Q.84 Which of the following expressions gives the area of flow for a Kaplan turbine?

Where,  $D$  = diameter,  $B$  = width of vane,  $D_0$  = outer diameter of runner,  $D_b$  = diameter of hub

- Ans
- 1.  $\pi D^2 B$
  - 2.  $\frac{\pi}{4} (D_0^2)$
  - 3.  $\pi D B$
  - 4.  $\frac{\pi}{4} (D_0^2 - D_b^2)$

Q.85 In a side milling cutter, the angle between the cleared flank of the blade and a tangent to the periphery in a diametral plane passing through the cutting edge is called \_\_\_\_\_.

- Ans
- 1. peripheral relief angle
  - 2. face relief angle
  - 3. peripheral clearance angle
  - 4. face clearance angle

Q.86 In a vapour absorption refrigeration system, heating, cooling and refrigeration take place at the temperatures of  $100^\circ\text{C}$ ,  $20^\circ\text{C}$  and  $-5^\circ\text{C}$ , respectively. Find the maximum C.O.P. of the system.

- Ans
- 1. 1.5
  - 2. 1.8
  - 3. 2.7
  - 4. 2.3

Q.87 According to the second law of thermodynamics, work is said to be \_\_\_\_\_ and heat is said to be \_\_\_\_\_.

- Ans
- 1. low-grade energy; low-grade energy
  - 2. high-grade energy; low-grade energy
  - 3. high-grade energy; high-grade energy
  - 4. low-grade energy; high-grade energy

Q.88 What is the purpose of a pattern in the casting pattern procedure?

- Ans
- 1. To clean the mould before casting
  - 2. To create the mould cavity
  - 3. To pour molten metal into the mould cavity
  - 4. To remove the casting from the mould

Q.89 What will be the average pressure in plate clutch when the axial force is 4 kN. The inside radius of the contact surface is 50 mm and the outside radius is 100 mm. Assume uniform wear.

- Ans
- 1.  $0.17 \text{ N/mm}^2$
  - 2.  $0.17 \text{ N/m}^2$
  - 3.  $1.7 \text{ N/mm}^2$
  - 4.  $17 \text{ N/mm}^2$

Q.90 In a P-V diagram, if  $pV = \text{Constant}$ , then the process is called

- Ans
- 1. adiabatic process
  - 2. constant-pressure process
  - 3. isothermal process
  - 4. constant-volume process

Q.91 A quick return motion mechanism used in shaper machine

- Ans
- 1. Complete return stroke as quickly as possible
  - 2. Maximize the time of forward stroke
  - 3. Complete cutting stroke as quickly as possible
  - 4. Reduce the motion of the machine

Q.92 What is the SI unit of surface tension?

- Ans
- 1. Unitless
  - 2.  $\frac{\text{N}}{\text{m}}$
  - 3.  $\frac{\text{N}}{\text{m}^2}$
  - 4.  $\frac{\text{N}}{\text{m}^3}$

Q.93 Which of the following materials is commonly used as a cutting tool material?

- Ans
- 1. Aluminium
  - 2. Brass
  - 3. Diamond
  - 4. Copper

Q.94 Which of the following is a requirement of a good ignition system?

- Ans
- 1. It should have good reproducibility of secondary voltage rise.
  - 2. It should have very low spark duration.
  - 3. It should give good performance at low speed but at high-speed, performance doesn't matter.
  - 4. It should be as small as possible in size.

Q.95 Which of the following governing methods is used for gas engines?

- Ans
- 1. Quantity governing
  - 2. Controlled governing
  - 3. Quality governing
  - 4. Hit-and-miss governing

Q.96 Which of the following is NOT a type of friction?

- Ans
- 1. Kinetic friction
  - 2. Dynamic friction
  - 3. Static friction
  - 4. Kinematic friction

Q.97 Under ideal conditions, for a drop of 80 kJ/kg enthalpy, what will be the approximate velocity of steam at the outlet of the nozzle if the inlet velocity of the steam is 2 m/s?

- Ans
- 1. 410 m/s
  - 2. 13 m/s
  - 3. 120 m/s
  - 4. 400 m/s

Q.98 The total pressure acting on any immersed body is independent of:

- Ans
- 1. the surface area of body
  - 2. the angle made by surface with the free surface of liquid
  - 3. the density of liquid
  - 4. the depth of C.G. of body from free surface of liquid

Q.99 The area under a P-V diagram represents \_\_\_\_\_.

- Ans
- 1. the net work done by the system
  - 2. the heat added to the system
  - 3. the heat rejected by the system
  - 4. the efficiency of the system

Q.100 Consider an air standard cycle in which the air enters the compressor at 1.0 bar and 20°C. The pressure of air leaving the compressor is 3.5 bar and the temperature at the turbine inlet is 600°C. For 1 kg of air, determine the efficiency of the cycle:

- Ans
- 1. 30%
  - 2. 32%
  - 3. 35%
  - 4. 25%





## Junior Engineer Civil Mechanical and Electrical Examination 2024 Paper I

Exam Date	06/06/2024
Exam Time	9:00 AM - 11:00 AM
Subject	Junior Engineer 2024 Civil Paper I

### Section : General Intelligence and Reasoning

Q1 In a certain code language, 'why him though' is coded as 'kl gi ok' and 'though is he' is coded as 'ok bi yg'. How is 'though' coded in the given language?

- Ans
- 1. bi
  - 2. gi
  - 3. kl
  - 4. ok

Q2 How many triangles are there in the given figure?

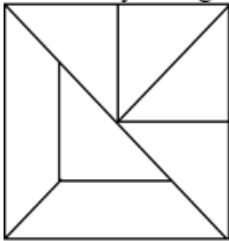

- Ans
- 1. 8
  - 2. 10
  - 3. 9
  - 4. 7

Q3 Read the given statements and conclusions carefully. You have to take the given statements to be true even if they seem to be at variance from commonly known facts. You have to decide which conclusion(s) logically follow(s) from the given statements.

Statements:

- Some curlers are serums.
- Some curlers are oils.

Conclusion (I): No oil is a serum.

Conclusion (II): All oils are serums.

- Ans
- 1. Only Conclusion (I) follows
  - 2. Only Conclusion (II) follows
  - 3. Neither Conclusion (I) nor (II) follows
  - 4. Both Conclusions (I) and (II) follow

Q4 What should come in place of the question mark (?) in the given series based on the English alphabetical order?  
DAG, FCI, HEK, JGM, ?

- Ans
- 1. KGN
  - 2. LIO
  - 3. MJP
  - 4. NLQ

Q5 What should come in place of the question mark (?) in the given series?  
6, 15, 34, 63, 102, ?

- Ans
- 1. 151
  - 2. 113
  - 3. 131
  - 4. 105

Q.6 What should come in place of ? in the given series based on the English alphabetical order?  
GMC, JPF, MSI, PVL, ?

- Ans
- 1. QZP
  - 2. RYP
  - 3. SYO
  - 4. QXO

Q.7 A dice has its faces marked by symbols  $\sigma$ ,  $\Delta$ ,  $\mu$ ,  $\epsilon$ ,  $\omega$  and  $\gamma$ . Two positions of the same dice are shown below. Which face is opposite to face  $\Delta$ ?

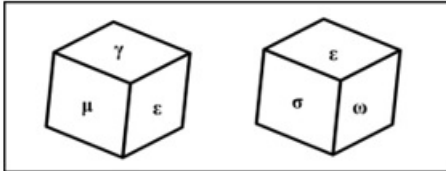

- Ans
- 1.  $\epsilon$
  - 2.  $\gamma$
  - 3.  $\mu$
  - 4.  $\sigma$

Q.8 OJNL is related to NIMK in a certain way based on the English alphabetical order. In the same way, LGKI is related to KFJH. To which of the following is IDHF related, following the same logic?

- Ans
- 1. HCGE
  - 2. HCEG
  - 3. HEGC
  - 4. HECG

Q.9 In a certain code language, 'GATE' is coded as '3579' and 'THIN' is coded as '4236'. What is the code for 'T' in that language?

- Ans
- 1. 2
  - 2. 3
  - 3. 4
  - 4. 7

Q.10 The position(s) of how many letters will remain unchanged if each of the letters in the word CLANGED is arranged in the English alphabetical order?

- Ans
- 1. Two
  - 2. One
  - 3. Three
  - 4. Four

Q.11 What should come in place of the question mark (?) in the given series?

28, 29, 27, 30, 26, ?

- Ans
- 1. 24
  - 2. 31
  - 3. 32
  - 4. 25

Q.12 In a certain code language, 'FRIAR' is coded as '20' and 'FREEDOM' is coded as '28'. What is the code for 'FARROW' in the given language?

- Ans
- 1. 18
  - 2. 22
  - 3. 17
  - 4. 24

Q.13 What will come in the place of the question mark (?) in the following equation, if '+' and '÷' are interchanged and '×' and '-' are interchanged?  
 $19 \times 6 \div 10 - 2 + 1 = ?$

- Ans
- 1. 28
  - 2. 48
  - 3. 36
  - 4. 33

Q.14 SUWY is related to ZXVT in a certain way based on the English alphabetical order. In the same way, JLNP is related to QOMK. To which of the following is ACEG related, following the same logic?

- Ans
- 1. HFDB
  - 2. FHBD
  - 3. BDFH
  - 4. DHBF

Q.15 Select the triad in which the numbers are related to each other in the same way as are the numbers of the given triads.  
(NOTE: Operations should be performed on the whole numbers, without breaking down the numbers into its constituent digits. E.g. 13 – Operations on 13 such as adding /deleting /multiplying etc. to 13 can be performed. Breaking down 13 into 1 and 3 and then performing mathematical operations on 1 and 3 is not allowed.)  
(279, 246, 213)  
(184, 151, 118)

- Ans
- 1. (194, 151, 108)
  - 2. (169, 132, 103)
  - 3. (225, 196, 123)
  - 4. (176, 145, 119)

Q.16 M, O, N, S, T, E, and R are sitting around a circular table, facing the centre (not necessarily in the same order). O sits to the immediate right of M. M sits second to the right of S. E sits third to the left of S. T sits second to the right of R.  
Who are the immediate neighbours of N?

- Ans
- 1. E and R
  - 2. R and M
  - 3. S and T
  - 4. E and O

Q.17 If 'A' stands for '÷', 'B' stands for '×', 'C' stands for '+' and 'D' stands for '-', what will come in place of the question mark '?' in the following equation?

$$28 B 4 D 20 A 5 C 8 = ?$$

- Ans
- 1. 117
  - 2. 116
  - 3. 122
  - 4. 119

Q.18 The position(s) of how many letters will remain unchanged if each of the letters in the word 'ALIMONY' is arranged in the English alphabetical order?

- Ans
- 1. Four
  - 2. Two
  - 3. Three
  - 4. None

Q.19 What should come in place of the question mark (?) in the given series based on the English alphabetical order?  
SJF, ZQM, GXT, NEA, ?

- Ans
- 1. YLH
  - 2. ULH
  - 3. YLG
  - 4. ULG

Q.20 Select the option that indicates the correct arrangement of the given words in a logical and meaningful order.

1. Asia
2. Guwahati
3. North Eastern Indian State
4. South Asia
5. Assam

- Ans
- 1. 2, 5, 3, 4, 1
  - 2. 5, 3, 2, 4, 1
  - 3. 5, 2, 3, 4, 1
  - 4. 2, 5, 3, 1, 4

Q.21 17 is related to 237 following a certain logic. Following the same logic, 9 is related to 125. To which of the following is 12 related following the same logic?  
(NOTE: Operations should be performed on the whole numbers, without breaking down the numbers into their constituent digits. E.g. 13 – Operations on 13 such as adding / subtracting / multiplying to 13 can be performed. Breaking down 13 into 1 and 3 and then performing mathematical operations on 1 and 3 is not allowed.)

- Ans
- 1. 166
  - 2. 132
  - 3. 167
  - 4. 179

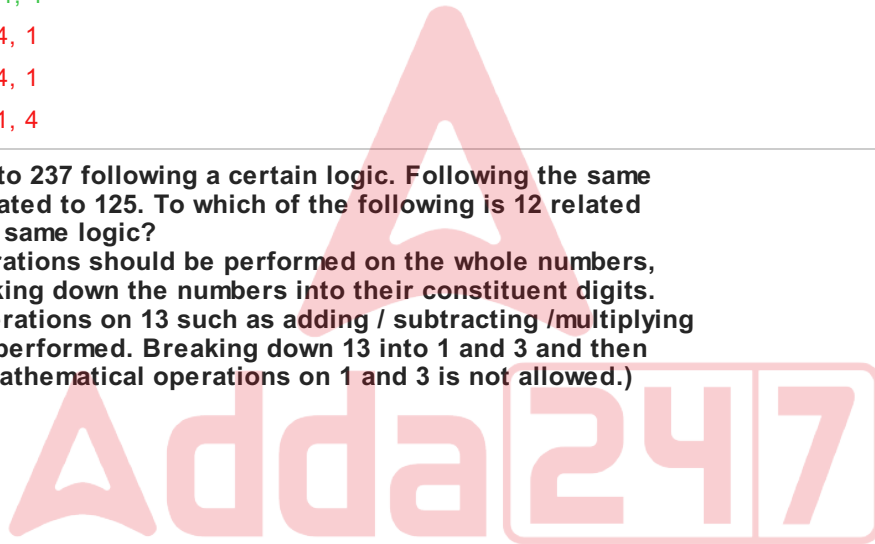

Q22 Select the option figure that can replace the question mark (?) in the figure given below to complete the pattern.

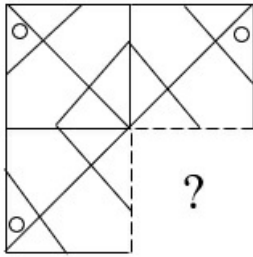

Ans

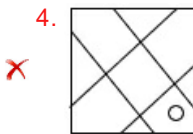
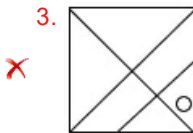
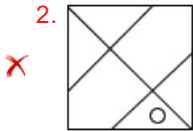
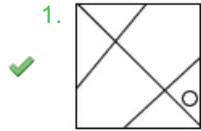

Q23 What should come in place of the question mark (?) in the given series based on the English alphabetical order?  
PEB, SIE, VMH, YQK, BUN, ?

Ans

1. EXQ

2. CSL

3. DQM

4. EYQ

Q24 Six babies Ria, Sia, Tia, Urja, Vani and Winnie are born one after the other but not necessarily in the same order. All of them were born in different cities. Only two babies were born before the one who was born in Raipur. Only one baby was born between Sia, who was born in Delhi and the baby born in Raipur. Tia was born before Urja and just after the baby born in Haridwar. Tia was not born in Raipur. Ria was born in Bhopal and just before Vani. Tia was born immediately before the baby born in Ballia. Winnie was not born in Pune. Where was Winnie born?

Ans

1. Ballia

2. Haridwar

3. Delhi

4. Pune

Q.25 In the following number-pairs, the second number is obtained by applying certain mathematical operations to the first number. Select the set in which the numbers are related in the same way as are the numbers of the following sets.

(NOTE: Operations should be performed on the whole numbers, without breaking down the numbers into its constituent digits. E.g., 13 – Operations on 13 such as adding/subtracting/multiplying etc. to 13 can be performed. Breaking down 13 into 1 and 3 and then performing mathematical operations on 1 and 3 is not allowed.)

(15, 55)

(12, 43)

Ans ✓ 1. (7, 23)

✗ 2. (10, 40)

✗ 3. (9, 30)

✗ 4. (8, 42)

Q.26 LHKG is related to JFIE in a certain way based on the English alphabetical order. In the same way, RNQM is related to PLOK. To which of the following is UQTP related, following the same logic?

Ans ✓ 1. SORN

✗ 2. SONR

✗ 3. OSRN

✗ 4. OSNR

Q.27 In a certain code language, 'FISH' is coded as '3517' and 'SALT' is coded as '4258'.

What is the code for 'S' in the given code language?

Ans ✓ 1. 5

✗ 2. 1

✗ 3. 4

✗ 4. 8

Q.28 8 is related to 88 following a certain logic. Following the same logic, 12 is related to 132. To which of the following is 51 related, following the same logic?

(NOTE: Operations should be performed on the whole numbers, without breaking down the numbers into its constituent digits. E.g. 13 – Operations on 13 such as adding /subtracting /multiplying etc. to 13 can be performed. Breaking down 13 into 1 and 3 and then performing mathematical operations on 1 and 3 is not allowed.)

Ans ✓ 1. 561

✗ 2. 562

✗ 3. 563

✗ 4. 564

Q.29 Select the option that indicates the arrangement of the following words in meaningful and logical order.

1. Adult
2. Infant
3. Adolescent
4. Old age
5. Toddler

Ans ✓ 1. 2, 5, 3, 1, 4

✗ 2. 2, 1, 5, 4, 3

✗ 3. 5, 1, 3, 2, 4

✗ 4. 4, 1, 3, 2, 5

Q.30 Select the correct mirror image of the given figure when the mirror is placed at MN as shown below.

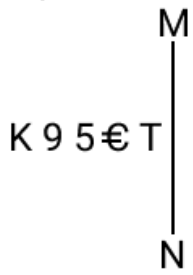

- Ans
- ✓ 1. T € 2 9 K
  - ✗ 2. T € 2 € T
  - ✗ 3. T € 2 9 K
  - ✗ 4. T € 2 1 K

Q.31 Select the word-pair that best represents a similar relationship to the one expressed in the pair of words given below.  
(The words must be considered as meaningful English words and must not be related to each other based on the number of letters/number of consonants/vowels in the word.)

Tranquil : Violent

- Ans
- ✗ 1. Vigilant : Alert
  - ✗ 2. Wicked : Vicious
  - ✓ 3. Timid : Bold
  - ✗ 4. Zeal : Eagerness



Adda247

Q.32 Select the option in which the given figure is embedded (rotation is NOT allowed).

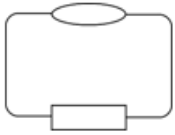

Ans 1.

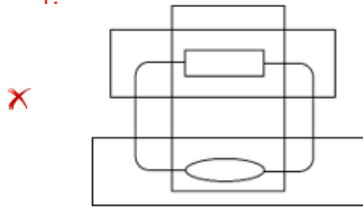

2.

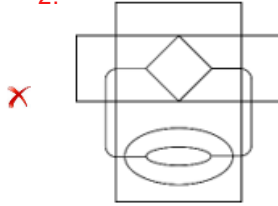

3.

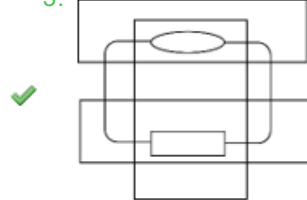

4.

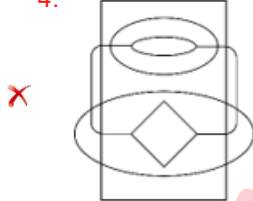

Q.33 Select the option in which the numbers share the same relationship as that shared by the given pairs of numbers.

2 : 16

3 : 81

(NOTE: Operations should be performed on the whole number, without breaking down the numbers into its constituent digits. E.g. 13- Operations on 13 such as adding/subtracting/multiplying etc. to 13 can be performed. Breaking down 13 into 1 and 3 and then performing mathematical operations on 1 and 3 is NOT allowed.)

Ans ✗ 1. 4 : 64

✓ 2. 4 : 256

✗ 3. 2 : 32

✗ 4. 6 : 216



Q.34 In a certain code language,  
 'M × N' means 'M is the daughter of N',  
 'M + N' means 'M is the father of N',  
 'M % N' means 'M is the mother of N', and  
 'M - N' means 'M is the brother of N'.  
 How is P related to K if 'P % Q + R - T × K'?

- Ans
- 1. Son's wife
  - 2. Husband's mother
  - 3. Mother's sister
  - 4. Brother's wife

Q.35 Select the option in which the given figure is embedded (rotation is NOT allowed).



Ans

- 1.
- 2.
- 3.
- 4.

Q.36 BHJL and CJMP are related to each other in a certain way based on the English alphabetical order. In the same way, CIKM and DKNQ are related to each other. Which of the following is related to DJLN, following the same logic?

- Ans
- 1. ELOR
  - 2. OERL
  - 3. EOLR
  - 4. OELR

Q.37 Anil starts from point A and drives 6 km towards the east. He then takes a left turn, drives 2 km, turns right, and drives 3 km. He then takes a right turn and drives 5 km. He takes a final right turn, drives 9 km, and stops at point P.  
How far (shortest distance) and towards which direction should he drive in order to reach point A again?  
(All turns are  $90^\circ$  turns only, unless specified.)

- Ans
- 1. 6 km towards the south
  - 2. 3 km towards the west
  - 3. 3 km towards the north
  - 4. 6 km towards the east

Q.38 In a certain code language,  
'A + B' means 'A is the father of B',  
'A - B' means 'A is the mother of B',  
'A × B' means 'A is the brother of B',  
'A ÷ B' means 'A is the sister of B' and  
'A \* B' means 'A is the husband of B'.  
How is T related to R if 'P ÷ R + Q × S - T \* U'?

- Ans
- 1. Daughter's son
  - 2. Son's son
  - 3. Son's daughter
  - 4. Daughter's daughter

Q.39 What should come in place of the question mark (?) in the given series?  
8, 24, 49, 85, 134, ?

- Ans
- 1. 198
  - 2. 181
  - 3. 191
  - 4. 180

Q.40 What should come in place of the question mark (?) in the given series based on the English alphabetical order?  
ECG, IGK, MKO, QOS, ?

- Ans
- 1. URV
  - 2. USW
  - 3. TSV
  - 4. USV

Q.41 What will come in place of the question mark (?) in the following equation if '+' and '×' are interchanged?  
 $132 \times 12 \div 9 + 27 - 51 = ?$

- Ans
- 1. 70
  - 2. 65
  - 3. 78
  - 4. 75

Q.42 What will come in the place of the question mark (?) in the following equation, if '÷' and '-' are interchanged and 'x' and '+' are interchanged?

$$15 \times 11 \div 49 - 7 + 3 = ?$$

- Ans
- 1. -15
  - 2. 5
  - 3. 15
  - 4. -5

Q.43 BKOT is related to DMQV in a certain way based on the English alphabetical order. In the same way, JHAP is related to LJCR. To which of the following is NEIM related, following the same logic?

- Ans
- 1. PGKO
  - 2. ADNG
  - 3. HJTF
  - 4. POLS

Q.44 AE 56 is related to EI 60 in a certain way. In the same way, WA 91 is related to AE 95. To which of the following is XB 77 related, following the same logic?

- Ans
- 1. PT 18
  - 2. HN 81
  - 3. IK 81
  - 4. BF 81

Q.45 Select the set in which the numbers are related in the same way as are the numbers of the following sets.  
(NOTE : Operations should be performed on the whole numbers, without breaking down the numbers into its constituent digits. E.g. 13 – Operations on 13 such as adding /subtracting /multiplying etc. to 13 can be performed. Breaking down 13 into 1 and 3 and then performing mathematical operations on 1 and 3 is not allowed)  
(100, 15)  
(118, 18)

- Ans
- 1. (100, 16)
  - 2. (120, 17)
  - 3. (94, 14)
  - 4. (80, 13)

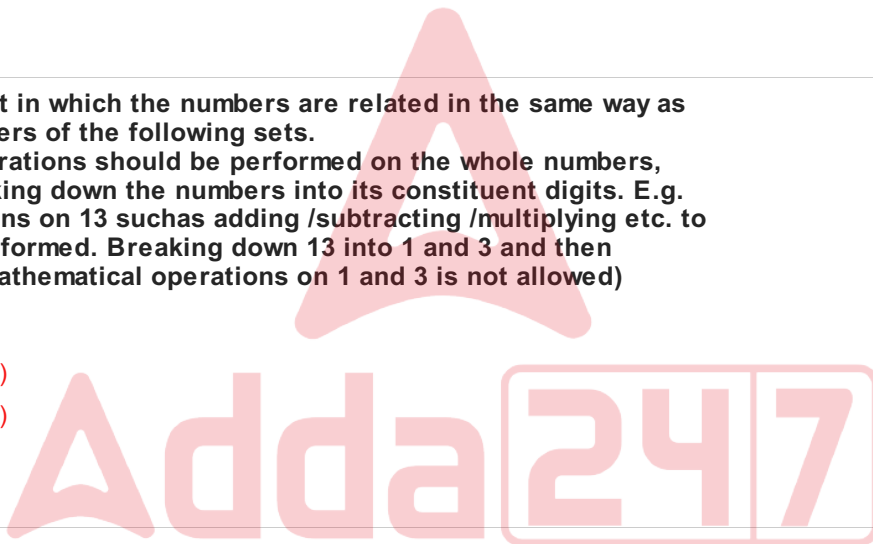

Q.46 Select the correct mirror image of the given figure when the mirror is placed at MN as shown below.

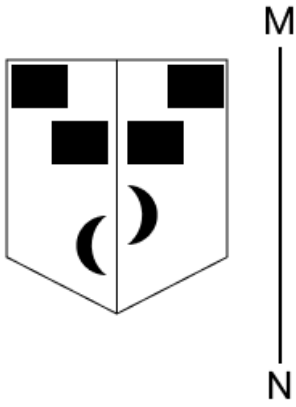

Ans

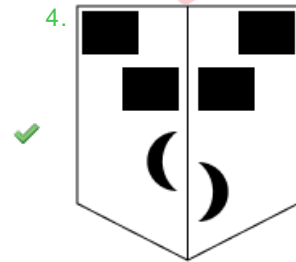
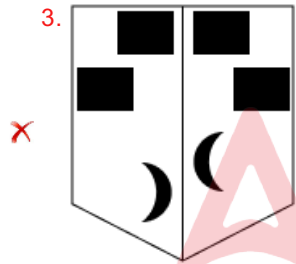
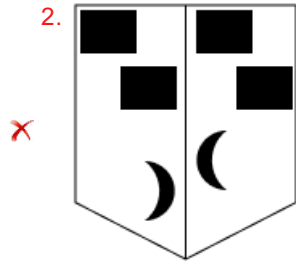
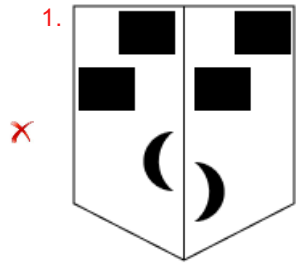

adda247

Q.47 What should come in place of the question mark (?) in the given series based on the English alphabetical order?  
MBT, ODV, QFX, SHZ, UJB, ?

- Ans
- 1. ULD
  - 2. VLE
  - 3. ULE
  - 4. WLD

Q.48 A, B, C, D, E, F, and G are sitting around a circular table, facing the centre (not necessarily in the same order). Only 2 people sit between C and F when counted from the right of C. A and D are immediate neighbours of G. E sits to the immediate left of B. Only 1 person sits between E and D when counted from the right of D. Who is sitting to the immediate right of G?

- Ans
- 1. C
  - 2. B
  - 3. A
  - 4. D

Q.49 Rajat drove for 4 km from point A, towards the west. He took a left turn and drove for 4 km. He took a left turn again and drove for 8 km and then he took a right turn and drove for 3 km. Again, he took a right turn and drove for 4 km. At last, he took a right turn and drove for 6 km and stopped at point B. How far (shortest distance) and towards which direction should he drive in order to reach point A again?  
(All turns are 90° turns only, unless specified.)

- Ans
- 1. 3 km towards the north
  - 2. 2 km towards the north
  - 3. 2 km towards the south
  - 4. 1 km towards the north

Q.50 Read the given statements and conclusions carefully. Assuming that the information given in the statements is true, even if it appears to be at variance with commonly known facts, decide which of the given conclusions logically follow(s) from the statements.

Statements: Some guitars are drums. Some drums are violins. No drum is a flute.

Conclusion (I): No flute is a violin.

Conclusion (II): Some flutes are guitars.

- Ans
- 1. Only conclusion (I) follows
  - 2. Only conclusion (II) follows
  - 3. Both conclusions (I) and (II) follow
  - 4. Neither conclusion (I) nor (II) follows

Section : General Awareness

Q.1 Which of the following is not a rock?

- Ans
- 1. Limestone
  - 2. Granite
  - 3. Quartz
  - 4. Marble

Q.2 All India Padma Shri Mohd. Shahid Invitational Prize Money Men's Hockey Tournament 2023 was organised in \_\_\_\_\_, Uttar Pradesh.

- Ans
- 1. Kanpur
  - 2. Lucknow
  - 3. Varanasi
  - 4. Gorakhpur

Q.3 Which Article of the Constitution of India guarantees the Right to Constitutional Remedies?

- Ans
- 1. Article 28
  - 2. Article 29
  - 3. Article 30
  - 4. Article 32

Q.4 Which level of ecological organisation includes all the different species living in a particular area?

- Ans
- 1. Community
  - 2. Population
  - 3. Ecosystem
  - 4. Habitat

Q.5 Sachindra Nath Sanyal established a branch of Anushilan Samiti at Patna in which of the following years?

- Ans
- 1. 1920
  - 2. 1929
  - 3. 1913
  - 4. 1925

Q.6 The Greek letter 'Omega' is used to represent which physical quantity in the International System of Units (SI)?

- Ans
- 1. Electrical conductance
  - 2. Electric resistance
  - 3. Electric displacement field
  - 4. Electric potential difference

Q.7 In business, what is a 'supply chain'?

- Ans
- 1. A series of businesses that supply products to one another
  - 2. The chain of command in a corporation
  - 3. A network of all entities involved in producing and delivering a product
  - 4. The total stock of a product in a market

Q.8 What was the child sex-ratio as per Census 2011 of India?

- Ans
- 1. 1000
  - 2. 890
  - 3. 919
  - 4. 1024

Q.9 Who among the following Sultans of the Khilji dynasty started giving cash salary to his soldiers and controlled the market during his reign?

- Ans
- 1. Alauddin Khilji
  - 2. Jalal-ud-din Khilji
  - 3. Shihab-ud-din Omar
  - 4. Qutb-ud-din Mubarak

Q.10 The Amrit Bharat Station Scheme launched in 2023 envisages to take-up \_\_\_\_\_ stations for upgradation/modernisation over the Indian Railway.

- Ans
- 1. 1108
  - 2. 1234
  - 3. 1309
  - 4. 1405

Q.11 Basanti Bisht, a Padma Shri awardee, is an Indian folk singer from which of the following states?

- Ans
- 1. Rajasthan
  - 2. Punjab
  - 3. Maharashtra
  - 4. Uttarakhand

Q.12 The Malwa Plateau is located in which of the following states?

- Ans
- 1. Jharkhand
  - 2. Tamil Nadu
  - 3. Madhya Pradesh
  - 4. Karnataka

Q.13 Which of the following princely states was annexed by the East India Company in the year 1852 AD under the Doctrine of Lapse?

- Ans
- 1. Udaipur
  - 2. Nagpur
  - 3. Sambalpur
  - 4. Satara

Q.14 A man started working in a factory where he needed to deal with steam and boiling water regularly. On the first day, his doctor warned him to be more careful of the steam because burns caused by steam can be more severe than that of hot water. What is the reason behind this?

- Ans
- 1. Steam cannot be seen
  - 2. Steam is odourless
  - 3. Steam has more latent heat of vaporisation
  - 4. Steam can remain stuck to the body

Q.15 Which of the following is NOT a part of the Directive Principles of State Policy of the Constitution of India?

- Ans
- 1. Protection and improvement of environment and safeguarding of forests and wildlife
  - 2. Protection of monuments and places and objects of national importance
  - 3. Provision for early childhood care and education to children below the age of six years
  - 4. Provision for protection of minority regions in Rajasthan

Q.16 Which of the following is INCORRECT about cooking of food?

- Ans
- 1. Makes it easier to digest
  - 2. Results in the loss of certain nutrients
  - 3. Destroys vitamin C easily
  - 4. Destroys vitamin D easily

Q.17 As of March 2023, who among the following is the Union Minister of Jal Shakti?

- Ans
- 1. Ramesh Pokhriyal
  - 2. Gajendra Singh Shekhawat
  - 3. Dharmendra Pradhan
  - 4. Giriraj Singh

Q.18 Which of the following bills was introduced in the Rajya Sabha by the Ministry of Law and Justice on 10 August 2023?

- Ans
- 1. The Chief Election Commissioner and other Election Commissioners (Appointment Conditions of Service and Term of Office) Bill, 2023
  - 2. The Bharatiya Nyaya Sanhita Bill, 2023
  - 3. The Digital Personal Data Protection Bill, 2023
  - 4. The Repealing and Amending Bill, 2023

Q.19 In May 2023, \_\_\_\_\_, the Comptroller and Auditor General of India (CAG), has been re-elected as the External Auditor of the World Health Organization (WHO) for a four-year term from 2024 to 2027.

- Ans
- 1. Kailasavadivoo Sivan
  - 2. Sushil Chandra
  - 3. KK Venugopal
  - 4. G C Murmu

Q.20 Soy milk is produced from:

- Ans
- 1. cow
  - 2. goat
  - 3. buffalo
  - 4. soybeans

Q.21 Which piece in a chess game can move in an 'L' shape – two squares vertically and one horizontally, and vice versa?

- Ans
- 1. Knight
  - 2. Bishop
  - 3. Queen
  - 4. Rook

Q.22 According to 'Basic Animal Husbandry Statistics 2023', which state has the highest production of Milk during the year 2022-2023?

- Ans
- 1. Rajasthan
  - 2. Gujarat
  - 3. Uttar Pradesh
  - 4. Maharashtra

Q.23 Identify whether the following statements are true (T) or false (F) with respect to the weather conditions of a place and select the correct option.

- A. It refers to change in temperature over a few years.
- B. It depends on the elevation of the area.
- C. It refers to temperature fluctuation within a day.

- Ans
- 1. TTT
  - 2. FFF
  - 3. FTT
  - 4. TTF



Q.24 Who discovered the staining technique called 'Black Reaction', which was capable of revealing neurons in their entirety?

- Ans
- 1. Robert Remak
  - 2. Albert Kolliker
  - 3. Camillo Golgi
  - 4. Jacques Loeb

Q.25 According to Census of India 2011, which state recorded the highest literacy rate in India?

- Ans
- 1. Kerala
  - 2. Goa
  - 3. Punjab
  - 4. Mizoram

Q.26 Who among the following was the governor of Telangana as the end of 2023?

- Ans
- 1. Tamilisai Soundararajan
  - 2. Kalraj Mishra
  - 3. Ganesh Lal
  - 4. Baby Rani Maurya

Q.27 What specialised nerve cells does the phylum Cnidaria have to capture and stun prey such as water fleas and plankton?

- Ans
- 1. collar cell
  - 2. stinging cell
  - 3. flame cell
  - 4. chief cell

Q.28 \_\_\_\_\_ was announced as part of the Atma Nirbhar Bharat Package in 2020 with the objective to help businesses including MSMEs to meet their operational liabilities and resume businesses in view of the distress caused by the COVID-19 crisis, by providing Member Lending Institutions (MLIs), 100 percent guarantee against any losses suffered by them due to non-repayment of the ECLGS funding by borrowers.'

- Ans
- 1. Emergency Credit Line Guarantee Scheme
  - 2. Mission Karmayogi
  - 3. Sahakar Pragya Yojana
  - 4. Stand-up India

Q.29 In 1946, BN Rao was formally appointed as \_\_\_\_\_ to the core drafting Committee of the Indian Constitution.

- Ans
- 1. Constitutional Advisor
  - 2. Chief Draftsman
  - 3. Vice-Chairman
  - 4. Anglo-Indian Representative

Q.30 What is the full form of 'CC' in the context of email?

- Ans
- 1. Common Copy
  - 2. Carbon Copy
  - 3. Confidential Copy
  - 4. Copy Communication

Q.31 In which plant tissue does photosynthesis primarily occur?

- Ans
- 1. Xylem
  - 2. Phloem
  - 3. Mesophyll
  - 4. Epidermis

Q.32 Ajit Pawar, who took oath as the Deputy Chief Minister of Maharashtra on 2 July 2023, belongs to which political party?

- Ans
- 1. Nationalist Congress Party (NCP)
  - 2. Jan Adhikar Party (JAP)
  - 3. Rashtriya Samaj Paksha (RSP)
  - 4. Maharashtra Navnirman Sena (MNS)

Q.33 In December 1885, \_\_\_\_\_ delegates from various parts of India established the Indian National Congress.

- Ans
- 1. 43
  - 2. 57
  - 3. 61
  - 4. 72

Q.34 Which of the following parts of an email is used to indicate the sender and recipient details, as well as the date and time?

- Ans
- 1. Subject line
  - 2. Body
  - 3. Email header
  - 4. Attachment

Q.35 The Parliamentary government is also known by which other names?

- 1: Cabinet government
- 2: Responsible government
- 3: Westminster model of government
- 4: Fixed executive system of government

- Ans
- 1. Only 1, 3 and 4
  - 2. Only 1, 2 and 3
  - 3. Only 1, 2 and 4
  - 4. Only 2, 3 and 4

Q.36 What is the impact of ocean acidification on coral reefs and shell-forming organisms?

- Ans
- 1. Ocean acidification has no impact on coral reefs.
  - 2. Ocean acidification enhances coral growth.
  - 3. Ocean acidification weakens coral skeletons and affects shell formation.
  - 4. Ocean acidification increases coral biodiversity.

Q.37 Which of the following is NOT a vector quantity?

- Ans
- 1. Acceleration
  - 2. Mass
  - 3. Velocity
  - 4. Force

Q.38 The SI unit of which fundamental physical quantity is named in the honour of Charles Augustin Coulomb?

- Ans
- 1. Electric field
  - 2. Electric current density
  - 3. Electric power
  - 4. Electric charge

Q.39 Which of the following minerals is essential for maintaining healthy bones and teeth?

- Ans
- 1. Fluoride
  - 2. Potassium
  - 3. Sodium
  - 4. Phosphorus

Q.40 Anupama Bhagwat is associated with which of the following musical instruments?

- Ans
- 1. Sarangi
  - 2. Sitar
  - 3. Surbahar
  - 4. Mridangam

Q.41 If the atomic mass of carbon is 12.011, that of hydrogen is 1.008 and that of oxygen is 15.999, then calculate the molecular mass of  $C_2H_4O$ .

- Ans
- 1. 40.053
  - 2. 34.053
  - 3. 44.053
  - 4. 16.053

Q.42 Which of the following institutions is referred to as 'lender of last resort'?

- Ans
- 1. NABARD
  - 2. SBI
  - 3. RBI
  - 4. SEBI

Q.43 The '\_\_\_\_\_ Devi Narmade' scheme has been undertaken by the government of Madhya Pradesh for the conservation of River Narmada.

- Ans
- 1. Jal
  - 2. Namami
  - 3. Pavitra
  - 4. Mata

Q.44 Calculate personal income from the following data.

- I. National Income = ₹1,000
- II. Corporate tax = ₹10
- III. Subsidies = ₹5
- IV. Undistributed profits = ₹15
- V. Rent = ₹15

- Ans
- 1. ₹975
  - 2. ₹950
  - 3. ₹1,000
  - 4. ₹980

Q.45 In electricity overloading cannot be caused by:

- Ans
- 1. connecting too many appliances to a single socket
  - 2. accidental hike in the supply voltage
  - 3. the live wire coming in direct contact with the neutral wire
  - 4. the live wire and the neutral wire coming into contact through a heavy resistance

Q.46 Who among the following was the first and the longest serving attorney general of India?

- Ans
- 1. Milon Kumar Banerji
  - 2. Niren De
  - 3. Motilal Chimanlal Setalvad
  - 4. Lal Narayan Sinha

Q.47 Which food item has pH value between 2 and 3? This value makes it acidic.

- Ans
- 1. Blackberry juice
  - 2. Tomato juice
  - 3. Lemon juice
  - 4. Apple juice

Q.48 Which cell organelle is the energy factory of cells and is an important hub for intracellular interactions with other organelles?

- Ans
- 1. Golgi apparatus
  - 2. Lysosomes
  - 3. Mitochondria
  - 4. Peroxisomes

Q.49 Which of the following is/are most essential for growth and development?

- Ans
- 1. High sugar
  - 2. Salts
  - 3. Protein
  - 4. Spices

Q.50 The National Awards to Teachers were first instituted in \_\_\_\_\_.

- Ans
- 1. 1972
  - 2. 1958
  - 3. 1947
  - 4. 1964

Section : General Engineering Civil and Structural

Q.1 Which of the following is a requirement for thermal insulation in materials?

- Ans
- 1. High temperature resistance
  - 2. Low density
  - 3. Low thermal conductivity
  - 4. High permeability

Q.2 The waste from printers, scanners, refrigerators, etc. is called \_\_\_\_\_.

- Ans
- 1. municipal waste
  - 2. industrial waste
  - 3. electrical waste
  - 4. e-waste

Q.3 The soil has a liquid limit of 50% and plastic limit of 25%, respectively. If the volumetric shrinkages at the liquid limit and plastic limit are 50% and 30%, respectively, determine the dry volume of soil, if the volume at liquid limit is 1 ml.

- Ans
- 1. 0.895 ml
  - 2. 0.485 ml
  - 3. 0.234 ml
  - 4. 0.667 ml

Q4 A road embankment with cross-sectional area of  $100 \text{ m}^2$  is constructed with an average gradient of 1 in 50 from contour 200 m to 250 m. Find the volume of the earth work.

- Ans
- 1. 250000  $\text{m}^3$
  - 2. 1250000  $\text{m}^3$
  - 3. 5000  $\text{m}^3$
  - 4. 22500  $\text{m}^3$

Q5 The prestressed concrete pavements for highways can be built without joints in continuous length up to how many metres?

- Ans
- 1. 45 metres
  - 2. 90 metres
  - 3. 60 metres
  - 4. 120 metres

Q6 In a fly levelling work, if the back sight staff reading is greater than fore sight staff reading, it indicates a \_\_\_\_\_ in ground level.

- Ans
- 1. horizontal surface
  - 2. rise
  - 3. fall
  - 4. level surface

Q7 A downward pointing equilateral triangle, having a red border and a white background is a:

- Ans
- 1. danger sign
  - 2. warning sign
  - 3. stop sign
  - 4. give way sign

Q8 Match the following.

Bin Colour	Type of Biomedical Waste
I. Yellow	A. To be incinerated
II. Red	B. To be autoclaved
III. Black	C. For burial

- Ans
- 1. I-A, II-B, III-C
  - 2. I-A, II-C, III-B
  - 3. I-B, II-A, III-C
  - 4. I-B, II-C, III-A

Q.9 Calculate the quantity of excavation of foundation for the given water tank.

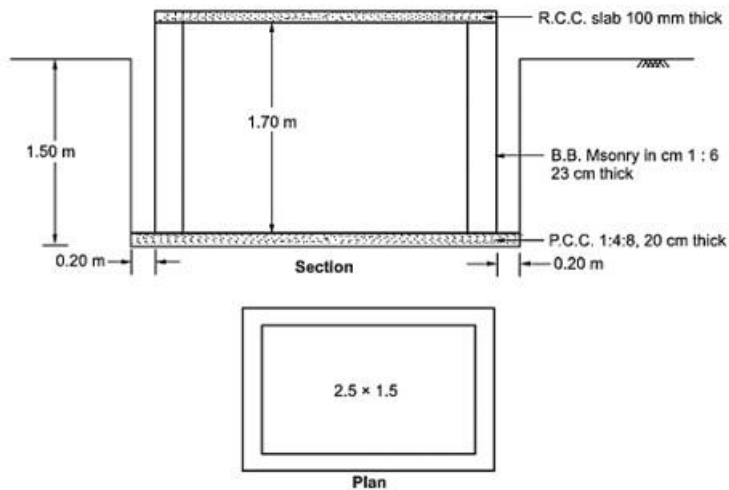

- Ans
- 1.  $2.36 \times 5.36 \times 1.5 \text{ m}^3$
  - 2.  $4.36 \times 2.36 \times 1.5 \text{ m}^3$
  - 3.  $1.36 \times 4.36 \times 1.5 \text{ m}^3$
  - 4.  $3.36 \times 2.36 \times 1.5 \text{ m}^3$

Q.10 Continuity equation used for fluid flowing through pipes is based on principle of \_\_\_\_\_

- Ans
- 1. Conservation of energy
  - 2. Conservation of momentum
  - 3. Conservation of mass
  - 4. Conservation of energy and momentum

Q.11 Automatic rain gauges are in the form of a pen mounted on a clock-driven chart and can give a permanent, automatic rainfall record. Which of the following is an example of automatic rain gauge?

- Ans
- 1. Hygrometer
  - 2. Hydrometer
  - 3. Symon's rain gauge
  - 4. Float type rain gauge

Q.12 A T-section is designated by ISNT 150 @ 223.7 N/m. What are the meanings of 150 and 223.7?

- Ans
- 1. It is 150 mm thick and the self-weight is 223.7 kg per metre length.
  - 2. It is 150 mm deep and the self-weight is 223.7 N per metre length.
  - 3. It is 150 mm thick and the self-weight is 223.7 N per metre length.
  - 4. It is 150 mm deep and the self-weight is 223.7 kg per metre length.

Q.13 Which of the following is an INCORRECT feature of the auto level instrument, used for levelling?

- Ans
- 1. Readings on the staff are taken manually.
  - 2. Initially, the instrument should be levelled roughly by using foot screws.
  - 3. The auto level works on the compensator mechanism.
  - 4. Readings on the staff are taken automatically.

Q.14 Estimate the flow cross sectional area in a triangular channel with 5 m depth, and side slope 2H:1V.

- Ans
- 1. 50 m<sup>2</sup>
  - 2. 60 m<sup>2</sup>
  - 3. 40 m<sup>2</sup>
  - 4. 80 m<sup>2</sup>

Q.15 As per IS 383:2016, the maximum crushing value of coarse aggregates used for runways and other wearing surfaces shall be \_\_\_\_\_ percentage.

- Ans
- 1. 50
  - 2. 10
  - 3. 12
  - 4. 30

Q.16 In 'No Parking' signs, the oblique red bar is placed at an angle of \_\_\_\_\_.

- Ans
- 1. 60 degrees
  - 2. 30 degrees
  - 3. 15 degrees
  - 4. 45 degrees

Q.17 The figure below represents a catchment area with the precipitations observed in a year. The mean precipitation calculated by using the Thiessen polygon method is \_\_\_\_\_.

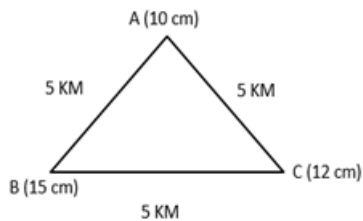

- Ans
- 1. 13.45 cm
  - 2. 12.33 cm
  - 3. 14.46 cm
  - 4. 11.28 cm

Q.18 Which of the following steel reinforcement does not act as a shear reinforcement in RCC beams?

- Ans
- 1. Bent up portion of longitudinal steel
  - 2. Stirrups perpendicular to beam axis
  - 3. Stirrups inclined (at 45") to beam axis
  - 4. Tension steel parallel to the beam axis

Q.19 As per IS standards on method of measurement of building and civil engineering works, the dimensions have to be measured to the nearest \_\_\_\_\_.

- Ans
- 1. 0.001 m
  - 2. 0.01 m
  - 3. 1.0 m
  - 4. 0.1 m

Q.20 Select the option that is appropriate regarding the following two statements labelled Assertion and Reason.  
Assertion: Piping below the weir can be prevented by providing an impervious floor of sufficient length so that the path of percolation is increased and the exit gradient is decreased.  
Reason: If the exit gradient is less than a certain critical value, the soil starts boiling and is washed away by percolating water.

- Ans
- 1. Assertion is true, but Reason is false.
  - 2. Both Assertion and Reason are false.
  - 3. Both Assertion and Reason are true, but Reason is not the correct explanation of Assertion.
  - 4. Both Assertion and Reason are true and Reason is the correct explanation of Assertion.

Q.21 A revised estimate should be accompanied by \_\_\_\_\_.

- Ans
- 1. an administrative sanction
  - 2. an abstract of bill
  - 3. a comparative statement
  - 4. a technical sanction

Q.22 \_\_\_\_\_ is that branch of science which deals with behaviour of the fluids (liquids or gases) at rest as well as in motion.

- Ans
- 1. Fluid mechanics
  - 2. Hydrostatics
  - 3. Hydrokinetics
  - 4. Hydrokinematics

Q.23 Calculate the effective length of a steel column of length 3 m that is effectively held in position at both ends and restrained in rotation at one end?

- Ans
- 1. 2.4 m
  - 2. 1.4 m
  - 3. 3.4 m
  - 4. 1 m

Q.24 All the voids of soil layer get filled with water after a heavy storm, upto a depth of 1 m from the surface. If the soil is dry below the depth of 1 m, the condition of soil upto the depth of 1 m below the surface is :

- Ans
- 1. saturated
  - 2. submerged
  - 3. dry
  - 4. capillary saturated

Q.25 When the staff reading increases between two consecutive points, the difference between the readings shall be recorded in \_\_\_\_\_ column in case of levelling by rise and fall method.

- Ans
- 1. R.L.
  - 2. H.I.
  - 3. Fall
  - 4. Rise

Q.26 Select the correct statement while designing a singly reinforced beam in the limit state method.

- Ans
- 1. Under reinforced beams have brittle failure.
  - 2. A designer may have multiple solutions.
  - 3. Only over reinforced beams are designed.
  - 4. Under reinforced beams have minimum cross section area.



Q.27 Which of the following is NOT a secondary treatment unit in wastewater treatment ?

- Ans
- 1. trickling filter
  - 2. Imhoff tank
  - 3. aerated lagoon
  - 4. aeration tank

Q.28 Where is lead glass commonly used in building construction?

- Ans
- 1. False ceiling
  - 2. Flooring works
  - 3. Facades and windows
  - 4. Plumbing and piping

Q.29 Estimate the earthwork quantity by trapezoidal formula method, for the construction of an approach road, whose length is 500m, base width of embankment =10m, height of embankment=70 cm and side slope = 1H:2V.

- Ans
- 1. 3377.5 cu. m
  - 2. 2500 cu. m
  - 3. 4500 cu. m
  - 4. 5000 cu. m

Q.30 Following the cubical content method of estimate for buildings, the estimated cost of building is determined by multiplying the total cubical contents of the building and ..... (Assume specifications and construction similar to buildings in the locality)

- Ans
- 1. area of the building
  - 2. local cubic rate
  - 3. height of the building
  - 4. volume of the building

Q.31 The following observation was made for a construction project where RL of the bench mark (BM) at Point A (bottom of a lintel) was 101.50 m.

The staff reading (inverted) on BM was 2.25 m and the reading at Point B on ground before the instrument was shifted was 1.05 m. After the change point, the staff reading to Point B measured 1.35 m. If the last reading was taken at the bottom of a canopy (Point C) with staff inverted was 4.100 m, RL of Point C was \_\_\_\_\_.

- Ans
- 1. 103.30 m
  - 2. 102.65 m
  - 3. 102.30 m
  - 4. 103.65 m

Q.32 Which of the following is the correct expression for slope  $\left(\frac{dy}{dx}\right)$  at any distance 'X' in a cantilever beam shown in the figure according to the double integration method?

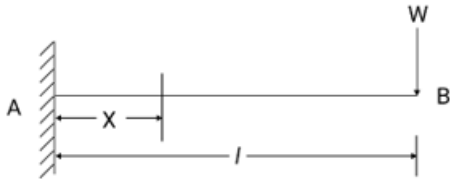

Where, EI is the flexural rigidity of beam section.

- Ans
- 1.  $\frac{dy}{dx} = -\frac{W}{2EI}(2l-x)$
  - 2.  $\frac{dy}{dx} = -\frac{W}{4EI}(2l-x)$
  - 3.  $\frac{dy}{dx} = -\frac{W}{2EI}(2lx-x^2)$
  - 4.  $\frac{dy}{dx} = -\frac{W}{4EI}(2lx-x^2)$

Q.33 Which of the following is NOT a reason for minor head loss in pipe flow?

- Ans
- 1. loss due to friction
  - 2. loss due to an exit of the pipe
  - 3. loss due to a bend in the pipe
  - 4. loss due to an entrance of the pipe

Q.34 Which of the following is NOT a bio-pesticide that helps in reducing soil pollution?

- Ans
- 1. Endosulphan
  - 2. Azadirachta indica
  - 3. Trichogramma
  - 4. Bacillus thuringiensis

Q.35 A cantilever beam AB of length 'l' is subjected to a downward load 'P' at its free end and an upward load 'P' at a distance of 'x' from the free end. The shear force will be \_\_\_\_\_.

- Ans
- 1. equal to P, between the two point loads
  - 2. equal to 2P, only at the free end
  - 3. equal to P/2, only at the free end
  - 4. equal to 2P, between the two point loads

Q.36 Which of the following factors contribute(s) to reducing soil pollution?

- I: Treating the water courses (drainage line treatment)
- II: Gabion structure
- III: Use of microbial pesticides

- Ans
- 1. Only I
  - 2. All of I, II and III
  - 3. Only I and III
  - 4. Only I and II

Q.37 The value of adopted ruling gradient on a highway road is 1 in 200. Calculate the percentage of ruling gradient provided on the road.

- Ans
- 1. 0.5%
  - 2. 1%
  - 3. 2.5%
  - 4. 5%

Q.38 Which types of trees grow inwards and fibrous mass is seen in their longitudinal sections?

- Ans
- 1. Conifers
  - 2. Deciduous
  - 3. Exogenous trees
  - 4. Endogenous trees

Q.39 Which of the following defects in timber occurs due to the faulty method of seasoning of timber?

- Ans
- 1. Wet rot
  - 2. Burl
  - 3. Honeycombing
  - 4. Shakes

Q.40 The stadia method used in tacheometric surveys generally refers to measurements taken with a \_\_\_\_\_.

- Ans
- 1. tacheometer with fixed stadia hair
  - 2. tacheometer with variable stadia hair
  - 3. fixed elvation of point
  - 4. fixed staff reading

Q.41 As per IS 456 : 2000, the limiting value for neutral axis depth measured from extreme fibre of a singly reinforced RCC beam with rectangular cross section is \_\_\_\_\_. Consider the grade of steel as Fe-500 and 'd' is effective depth of beam section.

- Ans
- 1. 0.53 d
  - 2. 0.46 d
  - 3. 0.44 d
  - 4. 0.48 d

Q.42 In the context of vehicular characteristics and efficiency of brakes, braking distance is:

- Ans
- 1. directly proportional to design coefficient of friction
  - 2. directly proportional to speed of vehicle
  - 3. inversely proportional to speed of vehicle
  - 4. inversely proportional to design coefficient of friction

Q.43 Net positive suction head(NPSH), which plays an important role in the proper selection of pumps is given by \_\_\_\_\_

- Ans
- 1. the product of Suction head and the liquids vapor head
  - 2. the sum of Suction head and the liquids vapor head
  - 3. the difference between Suction head and the liquids vapor head
  - 4. the ratio of Suction head and the liquids vapor head

Q.44 During construction of roads, a feature that facilitates drainage of the pavement laterally is called \_\_\_\_\_.

- Ans
- 1. camber
  - 2. shoulder
  - 3. median
  - 4. kerbs

Q.45 A sample of soil failed a triaxial test under a deviator stress of 200 kN/m<sup>2</sup> when the confining pressure was 100 kN/m<sup>2</sup>. If, for the sample, the confining pressure had been 200 kN/m<sup>2</sup>, what would have been the deviator stress at failure?  
(Assume  $\Phi = 0$ .)

- Ans
- 1. 400 kN/m<sup>2</sup>
  - 2. 500 kN/m<sup>2</sup>
  - 3. 200 kN/m<sup>2</sup>
  - 4. 100 kN/m<sup>2</sup>

Q.46 The upper limit on percentage longitudinal reinforcement in an RCC column has been kept in mind to serve which of the given option?

- Ans
- 1. To limit the size of the column
  - 2. To stop buckling of the column
  - 3. To cater easy placement and compaction of concrete in the column
  - 4. To limit the ductility of the column

Q.47 Which of the following is a sub-surface source of water supply?

- Ans
- 1. Dam
  - 2. Reservoir
  - 3. Tube well
  - 4. Streams

Q.48 Which of the following is/are the correct reason(s) for closing errors in compass surveying at the time of traversing?

- I. The end station of a traverse generally coincides exactly with its starting station.
- II. There is no error in the magnetic bearing observation.
- III. There is an error in the linear distance measurement.

- Ans
- 1. Only I and II
  - 2. Only I and III
  - 3. Only III
  - 4. I, II and III

Q.49 What is the primary factor that governs the shear strength of sands?

- Ans
- 1. Friction angle
  - 2. Void ratio
  - 3. Pore pressure
  - 4. Cohesion

Q.50 As per IS 456 :2000, the permissible limit for inorganic solids present in water that is used for construction activities is \_\_\_\_\_

- Ans
- 1. 3000 mg/l
  - 2. 1100 mg/l
  - 3. 150 mg/l
  - 4. 2400 mg/l

Q.51 The table below shows the data sheet from a levelling book. If the RL at station P is 550.50 m, then which of the following options is INCORRECT?

Station	BS	IS	FS	Remark
P	1.265			BM
Q		1.415		
R		1.715		
S	2.330		2.165	CP
T			2.930	

(BS = Back Sight, IS = Intermediate Sight, FS = Fore Sight, RL = Reduced Level, BM = Bench Mark and CP = Change Point)  
(All figures are in metre.)

- Ans
- 1. Station S is at a lower elevation than Station P.
  - 2. Station R is at a higher elevation than Station P.
  - 3. Station R is at a higher elevation than Station T.
  - 4. Station S is at a lower elevation than Station Q.



Q.52 Which of the following is correct expression to compute design bending strength of a laterally unsupported beam?

Where  $f_{bd}$  = design bending compressive stress,  
 $\beta_b = Z_e/Z_p$ ,  $Z_e$  = Elastic section modulus and  $Z_p$  = Plastic section modulus

- Ans
- 1.  $M_d = Z_p f_{bd}$
  - 2.  $M_d = \beta_b Z_p / f_{bd}$
  - 3.  $M_d = \beta_b f_{bd} / Z_p$
  - 4.  $M_d = \beta_b Z_p f_{bd}$

Q.53 If lining is provided to the canals, seepage loss of water can be controlled and ultimately it \_\_\_\_\_ the irrigated command area of the project.

- Ans
- 1. doesn't affect
  - 2. neither increases nor reduces
  - 3. increases
  - 4. decreases

**Q.54** Which of the following types of construction offers comparatively better earthquake resistance based on its structural action? Consider that the thickness and length of member to be constructed is constant for any of the following cases.

- Ans
- 1. Random rubble stone masonry
  - 2. Size stone masonry
  - 3. Reinforced brickwork
  - 4. Brickwork with English bond

**Q.55** The modulus of elasticity of a material is:

- Ans
- 1. not referred to as Young's modulus
  - 2. only defined in the linearly elastic region
  - 3. having the same unit as that of strain
  - 4. equal to the slope of the strain–stress curve

**Q.56** The temperature at which vitrification of low melting clay bricks occurs at a temperature of \_\_\_\_\_.

- Ans
- 1. 1200°C-1400°C
  - 2. 300°C-500°C
  - 3. 600°C-800°C
  - 4. 900°C-1100°C

**Q.57** The velocity components of a two-dimensional plane motion of a fluid with constant density are  $u = 2x - x^2y$  and  $v = xy^2 - 2y$ . Which of the following is the correct statement?

- Ans
- 1. The fluid is incompressible and flow is steady.
  - 2. The fluid is compressible and flow is unsteady.
  - 3. The fluid is compressible and flow is steady.
  - 4. The fluid is incompressible and flow is unsteady.

**Q.58** Which of the following precaution is generally followed in cold weather concreting and not in hot weather concreting?

- Ans
- 1. Use of an air-entraining agent
  - 2. Sprinkling of formwork with cooled water
  - 3. Covering the finished concrete surface by impermeable sheet
  - 4. Cooling of aggregates

**Q.59** In a barometer, air is trapped in the space labelled 'A' above the mercury level in the tube of the barometer, which measures 730 mmHg. If the atmospheric pressure is 750 mmHg, then the pressure of the trapped air is:

- Ans
- 1. 20 mmHg
  - 2. 750 mmHg
  - 3. 730 mmHg
  - 4. 745 mmHg

**Q.60** The material supported by a retaining wall kept above the horizontal plane at the elevation of the top of the retaining wall is known as:

- Ans
- 1. infill
  - 2. surcharge
  - 3. backfill
  - 4. debris

Q.61 The design shear strength of concrete in the RCC beam does NOT depend on the:

- Ans
- 1. grade of concrete
  - 2. cross-sectional dimension of the beam
  - 3. grade of steel
  - 4. area of steel

Q.62 An economical cross-section of an irrigation canal is formed partly in cutting and partly in filling, with the depth of cutting in canal cross-section equal to balancing depth. What does this indicate ?

- Ans
- 1. Wetted perimeter of cutting portion of canal = Wetted perimeter of the filling portion of canal
  - 2. Depth of earthwork cutting = Depth of earthwork in filling
  - 3. Quantity of earthwork in filling = Two times the quantity of earthwork in cutting
  - 4. Quantity of earthwork in cutting = Quantity of earthwork in filling

Q.63 Which of the following sewer sections has the least perimeter for a given cross-sectional area?

- Ans
- 1. Egg-shaped sewer
  - 2. Circular sewer
  - 3. Parabolic sewer
  - 4. Rectangular sewer

Q.64 Which irrigation method has the highest irrigation efficiency?

- Ans
- 1. Sprinkler irrigation
  - 2. Drip irrigation
  - 3. Border strip irrigation
  - 4. Furrow

Q.65 Select the option that is appropriate regarding the following two statements labelled Assertion and Reason.

**Assertion:** In urban areas, roofing on built-up areas, concrete and asphalt surfaces are major factors that inhibit infiltration and surface retention.

**Reason:** The presence of pervious surface areas decreases infiltration and initial losses and leads to consequent increase in the effective rainfall.

- Ans
- 1. Both Assertion and Reason are false.
  - 2. Both Assertion and Reason are true and Reason is the correct explanation of Assertion.
  - 3. Both Assertion and Reason are true, but Reason is not the correct explanation of Assertion.
  - 4. Assertion is true, but Reason is false.

Q.66 As per IS 456:2000, the maximum compressive strain at highly compressed fiber in RCC column subjected to bending and axial compression is given by: (Consider no tension in the section).

- Ans
- 1.  $0.002 - 0.75 \times$  (strain at the least compressed extreme fiber)
  - 2.  $0.002 + 0.75 \times$  (strain at the least compressed extreme fiber)
  - 3.  $0.0035 + 0.75 \times$  (strain at the least compressed extreme fiber)
  - 4.  $0.0035 - 0.75 \times$  (strain at the least compressed extreme fiber)

Q.67 In which type of the finish is the booster or chisel used to make non-continuous parallel marks on the stone surface? These marks may be horizontal, inclined, or vertical.

- Ans
- 1. Dragged or combed finish
  - 2. Rubbed finish
  - 3. Hammer dressed finish
  - 4. Furrowed finish dressing of stones

Q.68 Which of the following types of foundation is suitable for cohesive soil with high load bearing capacity and load can be distributed over a wide area compared to other foundation types?

- Ans
- 1. Strip foundation
  - 2. Pier foundation
  - 3. Pile foundation
  - 4. Raft foundation

Q.69 Which of the following municipal solid wastes CANNOT be recycled?

- Ans
- 1. Papers
  - 2. Fruit peelings
  - 3. Glasses
  - 4. Plastics

Q.70 Hazard markers should reflect \_\_\_\_\_ light, visible at least from a distance of about \_\_\_\_\_.

- Ans
- 1. red; 500 m
  - 2. yellow; 150 m
  - 3. red; 150 m
  - 4. yellow; 500 m

Q.71 What is potential head?

- Ans
- 1. Kinetic energy per unit weight of fluid particle
  - 2. Potential energy per unit mass of fluid particle
  - 3. Pressure energy per unit weight of fluid particle
  - 4. Potential energy per unit weight of fluid particle

Q.72 The passive earth pressure for a soil is -----

- Ans
- 1. always greater than active earth pressure
  - 2. equal to earth pressure at rest
  - 3. always less than the earth pressure at rest
  - 4. equal to active earth pressure

Q.73 The part of the runoff that enters the stream immediately after the rainfall is called direct runoff. The total direct runoff is the sum of \_\_\_\_\_.

- Ans
- 1. overland flow and infiltration
  - 2. surface runoff, infiltration and evapotranspiration
  - 3. rainfalls
  - 4. surface runoff, prompt interflow and channel precipitation

Q.74 If the specific weight of a certain liquid is  $5000\text{N/m}^3$ , then calculate the specific volume (in  $\text{m}^3/\text{N}$ ).

- Ans
- 1. 0.02
  - 2. 0.2
  - 3. 0.002
  - 4. 0.0002



Q.75 Which of the following factors is NOT considered while preparing a detailed estimate?

- Ans
- 1. Departmental charges
  - 2. Specifications for different items of work
  - 3. Transportation of materials
  - 4. Quantity of the materials

Q.76 Which of the following statements are correct with respect to grain size distribution curve?

I: The grain size distribution curve, having a horizontal line (parallel to x-axis) for some distance, shows poorly graded soil.

II: The grain size distribution curve, having a horizontal line (parallel to x-axis) for some distance, shows gap graded soil.

III: If the value of  $C_u$  (coefficient of uniformity) is large, it shows the presence of wide range of size of particles.

IV: If the value of  $C_u$  (coefficient of uniformity) is large, it shows the presence of narrow range of size of particles.

- Ans
- 1. I and III
  - 2. II and IV
  - 3. II and III
  - 4. I and IV

Q.77 Which estimate is prepared for administrative approval and technical sanction?

- Ans
- 1. Supplementary estimate
  - 2. Complete estimate
  - 3. Detailed estimate
  - 4. Revised estimate

Q.78 The value of dynamic gauge (G) used to calculate the super elevation is \_\_\_\_ for broad gauge railway tracks.

- Ans
- 1. 1900 mm
  - 2. 1650 mm
  - 3. 1750 mm
  - 4. 1550 mm

Q.79 As per IS 13311 (part 1), the natural frequency of transducers for a path length of more than 1500 mm is \_\_\_\_\_.

- Ans
- 1. greater than or equal to 10 kHz
  - 2. greater than or equal to 20 kHz
  - 3. less than 5 kHz
  - 4. greater than or equal to 50 kHz

Q.80 Which property of timber makes it resistant to corrosion and rust?

- Ans
- 1. Non-metallic composition
  - 2. High strength
  - 3. Low density
  - 4. High moisture absorption

Q.81 Identify whether the following statements about sanitary landfill are true or false.

Statement I: There is continuous evolution of foul gases near the fill side.

Statement II: During rainy season, leachate may come out of the dump.

Statement III: The method requires further treatments for completion.

- Ans
- 1. Statement I is true, but Statements II and III are false
  - 2. Statements I and III are true, but Statement II is false
  - 3. Statements I and II are false and Statement III is true
  - 4. Statements I and II are true, but Statement III is false

Q.82 Absolute pressure is equal to:

- Ans
- 1. Gauge pressure + Atmospheric pressure
  - 2. Gauge pressure – Atmospheric pressure
  - 3. Atmospheric pressure × Gauge pressure
  - 4. Atmospheric pressure – Gauge pressure

Q.83 For a retaining wall, the Mohr circle radius for active earth pressure is \_\_\_\_\_ the Mohr circle radius for passive earth pressure.

- Ans
- 1. equal to
  - 2. less than
  - 3. more than
  - 4. More or less depending on the angle of internal friction of soil

Q.84 What is the meaning of a signal 'Left arm extended' given by a surveyor?

- Ans
- 1. Move considerably towards your left
  - 2. Plumb the rod towards your left
  - 3. Move slowly towards your left
  - 4. Continue to move towards your left

Q.85 As per Kennedy's theory, the ratio of the mean velocity 'V' to the critical velocity 'VO' is known as the critical velocity ratio. It is denoted by 'm'. If  $m > 1$ , \_\_\_\_\_ will occur.

- Ans
- 1. scouring
  - 2. both scouring and silting
  - 3. silting
  - 4. neither scouring nor silting

Q.86 What is the application of geotechnical engineering in highway pavement design ?

- Ans
- 1. Analysis of stability of the camber slope
  - 2. Designing of the footing for rigid pavements
  - 3. Designing the thickness of flexible pavements
  - 4. Determination of traffic load

Q.87 Which of the following is a limitation of lightweight concrete when compared to conventional type concrete?

- Ans
- 1. Reduced density
  - 2. Enhanced thermal property
  - 3. Increased permeability
  - 4. Higher fire resistance

Q.88 What would be the average flow per hour (litre/hour) water consumption if 5000 litres is used per day?

- Ans
- 1. 400
  - 2. 500
  - 3. 100
  - 4. 208.33

Q.89 The elements included in the road margins are:

- Ans
- 1. embankment slope, driveway, carriageway, median
  - 2. footpath, shoulder, median, frontage road
  - 3. frontage road, shoulder, median, kerbs
  - 4. frontage road, parking lane, footpath, drive way

Q.90 Which of the following operation is meant for manual or automatic process by which air present in a centrifugal pump and its suction line is removed by filling liquid.

- Ans
- 1. starting of the electric motor
  - 2. the lubrication
  - 3. closure of the delivery valve
  - 4. closure of the suction valve

Q.91 Consider the following statements about the stability criterion of a gravity dam.

Statement I : If the force of friction is more than the force due to water pressure, the dam is safe against sliding.

Statement II : If the resultant of the weight of the dam and the horizontal force due to water pressure lies outside the base of the dam, but within  $h$  ( $h$  = height of the dam) from the face of the dam, the dam is safe against overturning.

Statement III : To avoid tension at the base of the dam, the maximum value of eccentricity is  $b/6$  on either side of geometrical axis of base section. Where,  $b$  is base width of dam. Which of the given statements is/are correct?

- Ans
- 1. Statements I and II
  - 2. Statements I and III
  - 3. Statement II only
  - 4. Statements II and III

Q.92 What amount of principle reinforcement materials is used in pultrusion process?

- Ans
- 1. 5% – 22%
  - 2. 40% – 70%
  - 3. 85% – 92%
  - 4. 22% – 38%

Q.93 Under which of the following condition an element subjected to stresses is said to be in a state of triaxial stress?

- Ans
- 1. When the shear stresses acting along three mutually perpendicular directions of the element
  - 2. When the principal stresses acting along three mutually perpendicular directions
  - 3. When the normal stress along two mutually perpendicular direction and shear stress along third direction
  - 4. When the stress acting along only one axis of the element

Q.94 Which of the following methods is/are used for disposal of the municipal solid waste?

I: Sanitary landfilling

II: Shredding or pulverisation

III: Barging out into the sea

Ans  1. Only I

2. Only II

3. All of I, II and III

4. Only I and II

Q.95 Which of the following materials is used for waterproofing during the construction of foundation and for protection of the structure from seepage problems?

Ans  1. Plaster of Paris

2. Portland cement

3. Pitch

4. Furnace slag

Q.96 Which characteristic of fine aggregates indicates their ability to retain water and affects the workability of concrete or mortar mix?

Ans  1. Fineness modulus

2. Water absorption

3. Particle size distribution

4. Specific gravity

Q.97 Due to segregation of well-mixed concrete, \_\_\_\_\_.

Ans  1. the workability of concrete decreases

2. the durability of concrete increases

3. the strength of concrete increases

4. the permeability of concrete decreases

Q.98 For a cantilever beam AB (A is fixed) of length L carrying a point load P at the free end, the slope equation obtained using double integration method is given below. Find the maximum deflection.

$$EI \frac{dy}{dx} = -P(Lx - \frac{x^2}{2})$$

E = Young's modulus

I = Moment of inertia

x is measured from the fixed end.

Ans  1.  $-\frac{PL^2}{3EI}$

2.  $-\frac{PL^3}{3EI}$

3.  $-\frac{PL^2}{6EI}$

4.  $-\frac{PL^3}{6EI}$

Q.99 Match the following.

Type of Water Pollution	Agent
I. Physical pollution	A. Sewage
II. Chemical pollution	B. Chromium
III. Bacteriological pollution	C. Fungi

- Ans
- ✓ 1. I-A, II-B, III-C
  - ✗ 2. I-A, II-C, III-B
  - ✗ 3. I-B, II-C, III-A
  - ✗ 4. I-B, II-A, III-C

Q.100 Select the option that is appropriate regarding the following two statements labelled Assertion and Reason.

**Assertion:** Rivers that flow through catchment areas having steep slopes carry a lot of sediment.

**Reason:** Steep slopes lead to high velocity of the flow, which causes more erosion of the surface soil.

- Ans
- ✗ 1. Assertion is true, but Reason is false.
  - ✗ 2. Both Assertion and Reason are true, but Reason is not the correct explanation of Assertion.
  - ✗ 3. Both Assertion and Reason are false.
  - ✓ 4. Both Assertion and Reason are true and Reason is the correct explanation of Assertion.



## Junior Engineer Civil Mechanical and Electrical Examination 2024 Paper I

Exam Date	06/06/2024
Exam Time	5:00 PM - 7:00 PM
Subject	Junior Engineer 2024 Civil Paper I

### Section : General Intelligence and Reasoning

**Q1** Select the triad in which the numbers are related to each other in the same way as are the numbers of the given triads.  
(NOTE: Operations should be performed on the whole numbers, without breaking down the numbers into its constituent digits. E.g. 13 – Operations on 13 such as adding /deleting /multiplying etc. to 13 can be performed. Breaking down 13 into 1 and 3 and then performing mathematical operations on 1 and 3 is not allowed.)  
(218, 121, 97)  
(254, 138, 116)

- Ans
- 1. (312, 194, 128)
  - 2. (267, 118, 129)
  - 3. (296, 147, 156)
  - 4. (325, 184, 141)

**Q2** Dilip starts from point A and drives 6 km towards the North. He then takes a right turn and drives 2 km. He then takes a left turn and drives 3 km. He then takes a left turn and drives 7 km. He takes a final left turn and drives 9 km to reach point B. How far (shortest distance) and towards which direction should he drive in order to reach Point A again? (All turns are 90 degrees turns only unless specified)

- Ans
- 1. 5 km East
  - 2. 6 km West
  - 3. 5 km West
  - 4. 3 km East

**Q3** If '+' means 'subtraction', '-' means 'division', '÷' means 'multiplication' and '×' means 'addition', then what will come in place of the question mark (?) in the following equation?  
 $30 - 5 \times 2960 + 74 \div 4 = ?$

- Ans
- 1. 2671
  - 2. 2670
  - 3. 2673
  - 4. 2674

Q4 Select the option figure that will replace the question mark (?) in the figure given below to complete the pattern.

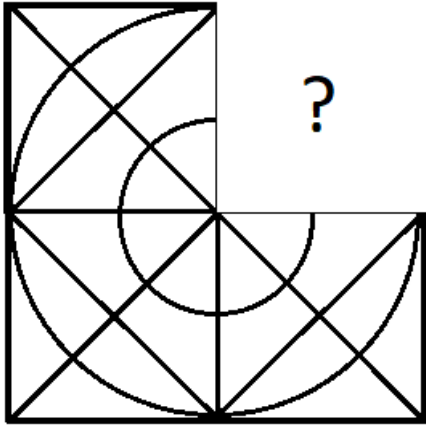

Ans

1.

✗

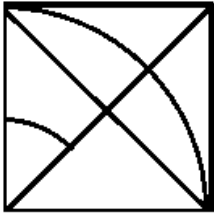

2.

✗

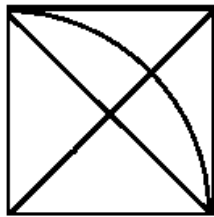

3.

✗

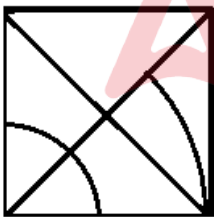

4.

✓

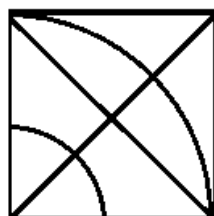

Q5 Select the correct mirror image of the given figure when the mirror is placed at MN as shown below.



- Ans
- 1. M Γ ∂° Y ∅
  - 2. W Γ ∂° Y ∅
  - 3. M ∟ % λ ∅
  - 4. M ∟ λ % ∅

Q6 What should come in place of the question mark (?) in the given series based on the English alphabetical order?  
LFC, IDZ, FBW, CZT, ZXQ, ?

- Ans
- 1. XZR
  - 2. UWM
  - 3. XYP
  - 4. WVN

Q7 What should come in place of the question mark (?) in the given series based on the English alphabetical order?  
VUR, TSP, RQN, POL, ?

- Ans
- 1. MLI
  - 2. NMK
  - 3. NMJ
  - 4. MLK

Q8 Seven friends S, Q, K, P, E, C and N have different ages. S is older than N but younger than E. K is older than P. Q is younger than E. C is younger than K. N is older than P. C is older than P. K is younger than Q. Which among them is the oldest?

- Ans
- 1. N
  - 2. Q
  - 3. K
  - 4. E

Q9 What should come in place of the question mark (?) in the given series?

44, 48, 52, 56, 60, 64, ?

- Ans
- 1. 72
  - 2. 66
  - 3. 70
  - 4. 68



Q.10 Select the set in which the numbers are related in the same way as are the numbers of the following sets.  
 (NOTE: Operations should be performed on the whole numbers, without breaking down the numbers into its constituent digits. E.g. 13 – Operations on 13 such as adding/subtracting/multiplying etc. to 13 can be performed. Breaking down 13 into 1 and 3 and then performing mathematical operations on 1 and 3 is not allowed.)  
 (16, 9, 14)  
 (33, 11, 44)

- Ans
- 1. (41, 23, 25)
  - 2. (18, 7, 22)
  - 3. (22, 6, 30)
  - 4. (17, 4, 22)

Q.11 A dice has its faces marked by letters R, S, T, U, V and W. Two positions of the same dice are shown below. Which face is opposite to face R?

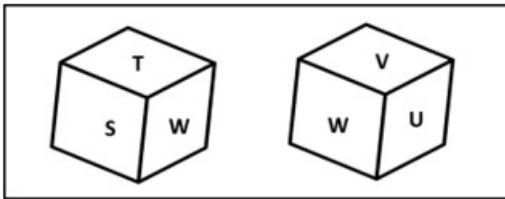

- Ans
- 1. V
  - 2. S
  - 3. W
  - 4. T

Q.12 What will come in place of the question mark (?) in the following equation if '+' and '-' are interchanged and 'x' and '÷' are interchanged?  
 $55 \times 5 - 3 \div 6 + 12 = ?$

- Ans
- 1. 17
  - 2. 15
  - 3. 13
  - 4. 21

Q.13 'TOUR' is related to 'VQWT' in a certain way based on the English alphabetical order. In the same way, 'QLRO' is related to 'SNTQ'. To which of the following is 'MHNK' related following the same logic?

- Ans
- 1. JOMP
  - 2. JOPM
  - 3. OJPM
  - 4. OJMP

Q.14 'UV 4' is related to 'WX 16' in a certain way based on the English alphabetical and numerical order. In the same way, 'PQ 3' is related to 'RS 9'. To which of the following is 'AB 5' related following the same logic?

- Ans
- 1. CD 10
  - 2. CD 25
  - 3. AC 25
  - 4. CE 25

Q.15 What will come in place of the question mark (?) in the following equation if '+' and '-' are interchanged and 'x' and '÷' are interchanged?

$$4 \div 5 + 21 \times 3 - 2 = ?$$

- Ans
- 1. 14
  - 2. 17
  - 3. 15
  - 4. 12

Q.16 A, B, C, D, P, Q और R एक गोल मेज के परितः उसके केंद्र की ओर अभिमुख होकर बैठे हैं (लेकिन जरूरी नहीं कि इसी क्रम में हों)। R के दायीं ओर से गिनने पर, D और R के बीच केवल तीन व्यक्ति बैठे हैं। R और Q दोनों का निकटतम पड़ोसी B है। P, D के बायीं ओर दूसरे स्थान पर बैठा है। C, D का निकटतम पड़ोसी नहीं है। R के दायीं ओर तीसरे स्थान पर कौन बैठा है?

- Ans
- 1. P
  - 2. Q
  - 3. A
  - 4. C

Q.17 Select the word-pair that best represents a similar relationship to the one expressed in the pair of words given below.  
(The words must be considered as meaningful English words and must not be related to each other based on the number of letters/number of consonants/vowels in the word.)

Pressure : Pascal

- Ans
- 1. Electric Current : Kelvin
  - 2. Work : Joule
  - 3. Momentum : Newton
  - 4. Force : Watt

Q.18 एक निश्चित कूट भाषा में,  
A @ B का अर्थ है 'A, B की माँ है'  
A - B का अर्थ है 'A, B का भाई है'  
A % B का अर्थ है 'A, B का पुत्र है'  
A ÷ B का अर्थ है 'A, B का पिता है'  
उपरोक्त के आधार पर, यदि 'E % F ÷ G - H @ M' है, तो E का M से क्या संबंध है?

- Ans
- 1. भाई
  - 2. नाना
  - 3. मामा
  - 4. पिता

Q.19 152 is related to 19 following a certain logic. Following the same logic, 232 is related to 29. To which of the following is 392 related, following the same logic?  
(NOTE: Operations should be performed on the whole numbers, without breaking down the numbers into its constituent digits. E.g. 13 - Operations on 13 such as adding/deleting/multiplying etc. to 13 can be performed. Breaking down 13 into 1 and 3 and then performing mathematical operations on 1 and 3 is not allowed.)

- Ans
- 1. 46
  - 2. 47
  - 3. 48
  - 4. 49

Q.20 What should come in place of the question mark (?) in the following series?

11, 17, 29, 47, 71, ?

- Ans
- 1. 100
  - 2. 99
  - 3. 102
  - 4. 101

Q.21 Pillar P is to the west of Pillar Q. Pillar R is to the east of Pillar Q. Pillar T is to the north of Pillar R. Pillar U is to the south of Pillar R. What is the position of Pillar Q with respect to Pillar U?

- Ans
- 1. North-West
  - 2. South-West
  - 3. North
  - 4. South



Q.22 Select the option in which the given figure is embedded (rotation is NOT allowed).

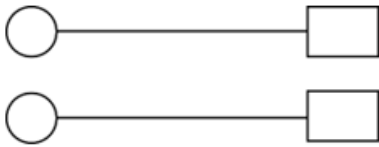

Ans

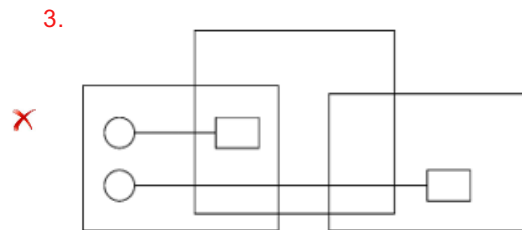
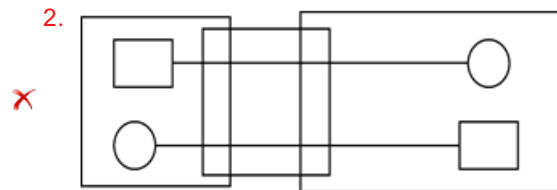
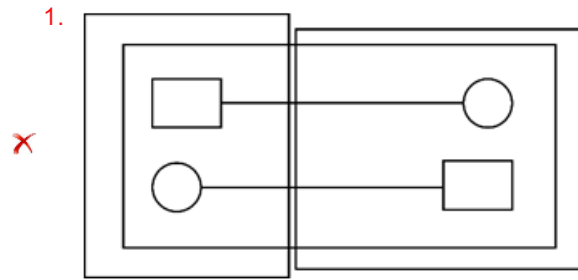

Q.23 Read the given statements and conclusions carefully. Assuming that the information given in the statements is true, even if it appears to be at variance with commonly known facts, decide which of the given conclusions logically follow(s) from the statements.

Statements: Some phones are tablets. Some tablets are laptops.

Conclusion 1: Some laptops are phones.

Conclusion 2: No phone is a laptop.

Ans

✗ 1. Only conclusion (2) follows

✓ 2. None of the conclusions follow

✗ 3. Both conclusion (1) and conclusion (2) follow

✗ 4. Only conclusion (1) follows

Q.24 How many triangles are there in the given figure?

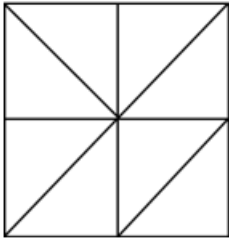

- Ans
- 1. 14
  - 2. 12
  - 3. 11
  - 4. 13

Q.25 Select the correct mirror image of the given figure when the mirror is placed at OG as shown below.

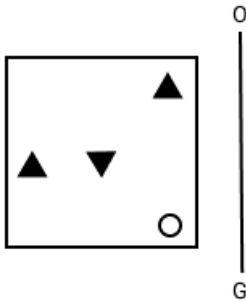

- Ans
- 1.
  - 2.
  - 3.
  - 4.

Q.26 The position(s) of how many letters will remain unchanged if each of the letters in the word SMOTHER is arranged in the English alphabetical order?

- Ans
- 1. Three
  - 2. Two
  - 3. Zero
  - 4. One

Q.27 What should come in place of the question mark (?) in the given series?

54, 43, 33, 24, 16, ?

- Ans
- 1. 11
  - 2. 6
  - 3. 9
  - 4. 8

Q.28 In a certain code language, 'FISH' is coded as '7913' and 'SALE' is coded as '8641'. What is the code for 'S' in the given language?

- Ans
- 1. 1
  - 2. 8
  - 3. 4
  - 4. 3

Q.29 123 is related to 223 following a certain logic. Following the same logic, 465 is related to 565. To which of the following is 786 related, following the same logic?

(NOTE: Operations should be performed on the whole numbers, without breaking down the numbers into its constituent digits. E.g. 13 – Operations on 13 such as adding/subtracting/multiplying etc. to 13 can be performed. Breaking down 13 into 1 and 3 and then performing mathematical operations on 1 and 3 is not allowed.)

- Ans
- 1. 686
  - 2. 786
  - 3. 886
  - 4. 986

Q.30 Select the set in which the numbers are related in the same way as are the numbers of the following sets.

(NOTE: Operations should be performed on the whole numbers, without breaking down the numbers into its constituent digits. E.g., 13 – Operations on 13 such as adding/subtracting/multiplying etc. to 13 can be performed. Breaking down 13 into 1 and 3 and then performing mathematical operations on 1 and 3 is not allowed.)  
(6, 18, 123)  
(17, 9, 168)

- Ans
- 1. (18, 5, 100)
  - 2. (21, 7, 147)
  - 3. (14, 8, 127)
  - 4. (20, 6, 94)

Q.31 CE 13 is related to GI 19 in a certain way. In the same way, KM 19 is related to OQ 25. To which of the following is SU 17 related, following the same logic?

- Ans
- 1. YZ 23
  - 2. LI 23
  - 3. WY 23
  - 4. MP 21

Q.32 Select the option in which the given figure is embedded (rotation is NOT allowed).

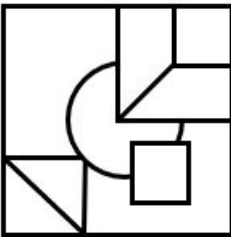
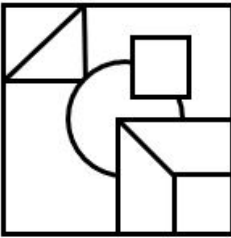
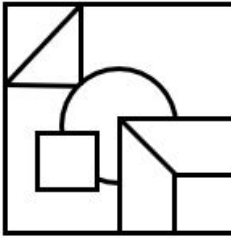
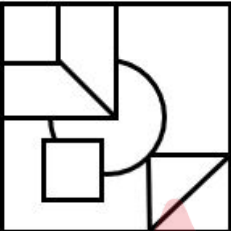

Ans

1. 
2. 
3. 
4. 

Q.33 What should come in place of the question mark (?) in the given series based on the English alphabetical order?  
FZP, DYU, BXZ, ZWE, ?

- Ans
- 1. YWN
  - 2. ZUM
  - 3. XVJ
  - 4. YOU

Q.34 What should come in place of the question mark (?) in the given series based on the English alphabetical order?  
NTZ, LRX, JPV, HNT, ?

- Ans
- 1. GLN
  - 2. GLR
  - 3. FLR
  - 4. FMR

Q.35 What will come in place of the question mark (?) in the following equation if '+' and '-' are interchanged and '×' and '÷' are interchanged?

$$42 \times 6 + 5 \div 8 - 34 = ?$$

- Ans
- 1. 1
  - 2. 3
  - 3. 4
  - 4. 5

Q.36 P, Q, R, S, T, U and V are sitting around a circular table facing the centre (not necessarily in the same order). P is sitting to the immediate left of V. R is sitting to the immediate right of T. U is sitting to the immediate left of P and immediate right of S. Q is sitting to the immediate left of S. T is sitting to the immediate right of V. Who is sitting to the immediate left of Q?

- Ans
- 1. V
  - 2. R
  - 3. P
  - 4. U

Q.37 एक निश्चित कूट भाषा में,  
'A + B' का अर्थ है कि 'A, B का पति है',  
'A - B' का अर्थ है कि 'A, B की पत्नी है',  
'A × B' का अर्थ है कि 'A, B का पिता है', और  
'A ÷ B' का अर्थ है कि 'A, B की बहन है'।  
यदि 'P - Q × R ÷ S + T' है, तो P का T से क्या संबंध है?

- Ans
- 1. पुत्र-वधु
  - 2. सास
  - 3. भाभी
  - 4. दादी

Q.38 In a certain code language, 'BOIL' is coded as '6428' and 'LEAD' is coded as '9671'. What is the code for 'L' in that language?

- Ans
- 1. 6
  - 2. 8
  - 3. 1
  - 4. 9

Q.39 CEG is related to KMO in a certain way based on the English alphabetical order. In the same way, GIK is related to OQS. To which of the following is MOQ related, following the same logic?

- Ans
- 1. UWY
  - 2. IKM
  - 3. BDF
  - 4. LNP

Q.40 PTOS is related to NRMQ in a certain way based on the English alphabetical order. In the same way, JNIM is related to HLGK. To which of the following is QUPT related, following the same logic?

- Ans
- 1. OSRN
  - 2. SONR
  - 3. SORN
  - 4. OSNR



Q41 What should come in place of the question mark (?) in the given series based on the English alphabetical order?

CGPY, KOXG, SWFO, AENW, ?

- Ans
- 1. IMVE
  - 2. IVEB
  - 3. IMNJ
  - 4. IKJU

Q42 Select the correct option that indicates the arrangement of the following words in a logical and meaningful order.

1. State
2. Village
3. District
4. Nation
5. House

- Ans
- 1. 4, 1, 3, 2, 5
  - 2. 4, 5, 2, 3, 1
  - 3. 4, 3, 5, 1, 2
  - 4. 4, 2, 1, 5, 3

Q43 Select the correct option that indicates the arrangement of the following words in a logical and meaningful order (in terms of food chain).

1. Grass
2. Grasshopper
3. Frog
4. Snake
5. Eagle

- Ans
- 1. 1, 2, 3, 4, 5
  - 2. 2, 3, 4, 5, 1
  - 3. 3, 4, 5, 2, 1
  - 4. 2, 4, 3, 1, 5

Q44 What should come in place of the question mark (?) in the given series based on the English alphabetical order  
PRT, LNP, HJL, DFH, ?

- Ans
- 1. YAD
  - 2. ZAD
  - 3. ZBD
  - 4. YBD

Q45 The position(s) of how many letters will remain unchanged if each of the letters in the word PLANKED is arranged in the English alphabetical order?

- Ans
- 1. Three
  - 2. Zero
  - 3. Two
  - 4. One

Q.46 Read the given statements and conclusions carefully. You have to take the given statements to be true even if they seem to be at variance from commonly known facts. You have to decide which conclusion/s logically follow/s from the given statements.

Statements: All plants are rocks. All rocks are lakes. No lake is a kite.

Conclusions:

(I) No rock is a kite.

(II) At least some lakes are plants.

- Ans
- 1. Both conclusions (I) and (II) follow.
  - 2. Only conclusion (I) follows.
  - 3. Neither conclusion (I) nor (II) follows.
  - 4. Only conclusion (II) follows.

Q.47 In a certain code language, 'he is right' is coded as 'ab yo km' and 'right now here' is coded as 'km gh bd'. How is 'right' coded in the given language?

- Ans
- 1. gh
  - 2. ab
  - 3. yo
  - 4. km

Q.48 PUQT is related to RWSV in a certain way based on the English alphabetical order. In the same way, SXTW is related to UZVY. To which of the following is KPLO related, following the same logic?

- Ans
- 1. NRMQ
  - 2. MRNP
  - 3. MRNQ
  - 4. NRQM

Q.49 Select the option in which the numbers share the same relationship as that shared by the given number triads.

9-5-1

14-10-6

(NOTE: Operations should be performed on the whole number, without breaking down the numbers into its constituent digits. E.g. 13- Operations on 13 such as adding/subtracting/multiplying etc. to 13 can be performed. Breaking down 13 into 1 and 3 and then performing mathematical operations on 1 and 3 is NOT allowed.)

- Ans
- 1. 30-28-26
  - 2. 20-16-12
  - 3. 21-16-14
  - 4. 25-21-19

Q.50 In a certain code language, 'DYO' is coded as '44' and 'PDX' is coded as '44'. What is the code for 'ZMB' in the given language?

- Ans
- 1. 48
  - 2. 41
  - 3. 56
  - 4. 52

Section : General Awareness

Q.1 Sahel is an area in Africa that has lost a huge area of productive land in the last century due to excessive human activities and climate change. This area is a blaring example of \_\_\_\_\_.

- Ans
- 1. failed Irrigation
  - 2. endangering species
  - 3. desertification
  - 4. pollution

Q.2 Which of the following options is used to check the spelling and grammar in a Microsoft Word document?

- Ans
- 1. Review tab
  - 2. Home tab
  - 3. Insert tab
  - 4. Format tab

Q.3 PT Usha clocked a timing of 55.42 sec in 400-metre hurdles at which of the following Olympic Games?

- Ans
- 1. 1980 Moscow
  - 2. 1984 Los Angeles
  - 3. 1948 London
  - 4. 1956 Melbourne

Q.4 The enzyme that is essential for fat digestion is:

- Ans
- 1. lipase
  - 2. trypsin
  - 3. zymase
  - 4. invertase

Q.5 What is the freezing point of water on the Celsius scale?

- Ans
- 1. 100°C
  - 2. 98°C
  - 3. 32°C
  - 4. 0°C

Q.6 What is a small, shallow freshwater body with calm water called?

- Ans
- 1. Lagoon
  - 2. Pond
  - 3. River
  - 4. Lake

Q.7 Which of the following features was borrowed by the Constitution of India from Ireland?

- Ans
- 1. Separation of Powers
  - 2. Directive Principles of State Policy
  - 3. Fundamental Rights
  - 4. Amendment Method

Q.8 भूस्खलन को कम करने के लिए निम्नलिखित में से कौन-से कदम उठाए जा सकते हैं?

- A. चिह्नित भूस्खलन-प्रवण क्षेत्रों में बस्तियों को बसाने से बचना चाहिए
- B. अनावश्यक वृक्षों एवं वनस्पतियों को काटना चाहिए
- C. मजबूत दीवारें बनानी चाहिए
- D. निर्माण से बचने के लिए जल निकासी व्यवस्था का निर्माण नहीं करना चाहिए

- Ans
- 1. केवल B और D
  - 2. B, C और D
  - 3. A और C
  - 4. A और B

Q.9 Which of the following pairs is NOT correctly matched?

- Ans
- 1. Commonwealth Games 2022 – England
  - 2. Olympics 2020 – Tokyo
  - 3. FIFA World Cup Football 2022 – Japan
  - 4. FIH Men Hockey World Cup 2023 – India

Q.10 The world's largest population of which endangered species resides in Assam's Kaziranga National Park?

- Ans
- 1. Shaggy horn wild ibex
  - 2. Bluebull
  - 3. One-horned rhinoceros
  - 4. Red panda

Q.11 By what name is Vitamin B1 known which is essential for glucose metabolism and healthy nerve, muscle and heart function?

- Ans
- 1. Thiamin
  - 2. Pantothenic acid
  - 3. Niacin
  - 4. Riboflavin

Q.12 According to Census of India 2011, what is the population growth rate in the Hindu community?

- Ans
- 1. 8.3%
  - 2. 24.9%
  - 3. 16.8%
  - 4. 30.2%

Q.13 What is the name of project undertaken by the Indian Government to conserve tigers when their population dwindled to very low numbers?

- Ans
- 1. Animal Protection
  - 2. Project Tiger
  - 3. Wildlife Conservation Project
  - 4. Predator Project

Q.14 Otto von Guericke was the most prominent person known for which invention in the 17th century?

- Ans
- 1. Fluorescent electric lamp
  - 2. Diesel engine
  - 3. Barometer
  - 4. Air pump

Q.15 What is the primary function of carbohydrates in the body?

- Ans
- 1. To regulate metabolism
  - 2. To enhance vision
  - 3. To build muscle
  - 4. To provide energy

Q.16 In the context of internet access, Wi-Fi stands for \_\_\_\_\_.

- Ans
- 1. Wired Fidelity
  - 2. Wireless Fidelity
  - 3. Wideband Fibre
  - 4. Web Interface

Q.17 According to Census of India 2011, which state recorded the second highest literacy rate in India?

- Ans
- 1. Nagaland
  - 2. Goa
  - 3. Tripura
  - 4. Mizoram

Q.18 Which of the following sentences is/are true?

- i. After independence, about two-thirds of India's population is now (2011 Census) literate.
- ii. In India, between 2001 and 2011, male literacy rose faster than female literacy.
- iii. Female literacy rose by about 10.4 per cent between 2001 and 2011 in India.

- Ans
- 1. Only i and ii
  - 2. Only ii and iii
  - 3. Only ii
  - 4. Only i and iii

Q.19 As per newest notification of december 2023, the decennial Census of India to be delayed till at least \_\_\_\_\_.

- Ans
- 1. January 2024
  - 2. October 2024
  - 3. March 2024
  - 4. July 2024

Q.20 Under the Regulating Act of 1773, the Supreme Court was established by British Emperor in which of the following cities in British India?

- Ans
- 1. Madras
  - 2. Bombay
  - 3. Calcutta
  - 4. Delhi

Q.21 What is the name of the scheme announced by Arunachal Pradesh Chief Minister Pema Khandu in September 2023 for the welfare of the state's labour force?

- Ans
- 1. Mukhya Mantri Shramik Suraksha Yojana
  - 2. Arunachal Shramik Vikas Yojana
  - 3. Labor Welfare Samriddhi Yojana
  - 4. Mukhya Mantri Shramik Kalyan Yojana

Q.22 If a government wants to boost economic growth in a recession, which measure is it likely to take?

- Ans
- 1. Implement strict trade barriers
  - 2. Increase taxes significantly
  - 3. Reduce public spending
  - 4. Increase public spending

Q.23 Which of the following lakes is located in Buldhana district of Maharashtra?

- Ans
- 1. Bhimtal
  - 2. Lonar
  - 3. Dal
  - 4. Pushkar

Q.24 What is the frequency of an object if we know that it oscillates 100 times in 5 seconds?

- Ans
- 1. 20 Hz
  - 2. 100 Hz
  - 3. 200 Hz
  - 4. 50 Hz

Q.25 The Gujarat Assembly, on 18 September 2023, approved a bill that reserves \_\_\_\_\_ of local body seats specifically for Other Backward Classes (OBCs).

- Ans
- 1. 20%
  - 2. 27%
  - 3. 30%
  - 4. 35%

Q.26 The supreme court has published new guidelines for which designation on 17 July 2023?

- Ans
- 1. District Judge
  - 2. Senior Advocate
  - 3. Judicial Magistrate
  - 4. Additional Senior Civil Judge

Q.27 The Indian Copper Complex (ICC) is located at Ghatsila in the state of \_\_\_\_\_.

- Ans
- 1. Jharkhand
  - 2. Telangana
  - 3. Maharashtra
  - 4. Rajasthan

Q.28 Which disease is characterised by the body's inability to regulate blood sugar levels?

- Ans
- 1. Diabetes
  - 2. Hypertension
  - 3. Arthritis
  - 4. Asthma

Q.29 If an atom has atomic number = 6 and number of neutrons = 10, then what is the atomic mass of the atom?

- Ans
- 1. 4
  - 2. 16
  - 3. 10
  - 4. 6

Q.30 What is the process by which one organism captures and consumes another organism called?

- Ans
- 1. Mutualism
  - 2. Competition
  - 3. Predation
  - 4. Parasitism

Q.31 The 'Rajya Sangeeta Vidwan' award is conferred by which state?

- Ans
- 1. Karnataka
  - 2. Tamil Nadu
  - 3. Andhra Pradesh
  - 4. Kerala

Q.32 When did the Indigo Revolt of Bengal take place?

- Ans
- 1. 1859 C.E.
  - 2. 1857 C.E.
  - 3. 1852 C.E.
  - 4. 1855 C.E.

Q.33 The basophilic nucleoprotein granules that are scattered within the cytoplasm of a nerve cell and helps in the protein synthesis are known as:

- Ans
- 1. Nissl bodies
  - 2. Subunit of Parson
  - 3. Oxisome
  - 4. Golgi bodies

Q.34 Who has been appointed as India's first Woman Aide-De-Camp by the governor of Mizoram?

- Ans
- 1. Abhilipsa Mohanty
  - 2. Poonam Veeram
  - 3. Deepa Shah
  - 4. Manisha Padhi

Q.35 Which of the following are the functions of the National Commission for Scheduled Castes?

- 1) Providing Constitutional protection to Scheduled Castes
- 2) Investigating any case that violates the interests of Scheduled Castes
- 3) Submitting a report to the Prime Minister related to the protection of Scheduled Castes
- 4) Presenting to the President, annually and at such other times as the Commission may deem fit, reports upon the working of those safeguards

- Ans
- 1. Only 1, 3 and 4
  - 2. Only 1, 2 and 3
  - 3. Only 1, 2 and 4
  - 4. Only 2, 3 and 4

Q.36 Sangeet Natak Akademi awardee, Prabhat Sarma from Assam was an eminent player of which of the following musical instruments?

- Ans
- 1. Tabla
  - 2. Sarod
  - 3. Flute
  - 4. Sarangi

Q.37 Which of the following sentence/s is/are NOT correct?

- i. The detailed estimates of revenue receipts are usually presented in the finance bill.
- ii. Non-tax revenue of the central government mainly consists of taxes imposed on goods imported into and exported out of India.
- iii. Revenue receipts are redeemable.

- Ans
- 1. Only i
  - 2. i and ii
  - 3. ii and iii
  - 4. i and iii

Q.38 Who was re-appointed as the Solicitor General of India for a term of three years starting from 1 July 2023?

- Ans
- 1. Suryaprakash V Raju
  - 2. Tushar Mehta
  - 3. Chetan Sharma
  - 4. Vikramjit Banerjee

Q.39 In dravidian style of temples the main temple tower is known as

- Ans
- 1. shikhara
  - 2. mandapa
  - 3. gopuram
  - 4. vimana

Q.40 Mahatma Gandhi gave the slogan of 'Do or Die' during the

- Ans
- 1. Non-Cooperation Movement
  - 2. Quit India Movement
  - 3. Kheda Satyagraha
  - 4. Champaran Satyagraha

Q.41 Which system of India is based on the Westminster model?

- Ans
- 1. Indian Parliamentary system
  - 2. Welfare State system
  - 3. Federal system
  - 4. Strong Centre system

Q.42 How many items did the Swaran Singh Committee recommend to be incorporated in the Constitution of India as duties of the Indian citizen?

- Ans
- 1. 8
  - 2. 10
  - 3. 12
  - 4. 6



Q.43 If the meat is cooked above 140°C, which of the following reactions occurs?

- Ans
- 1. Caramelisation
  - 2. Oxidation reaction
  - 3. Emulsification
  - 4. Maillard reaction

Q.44 Who was the chairman of the task force on the production and promotion of biofertilizers constituted by NITI Aayog in 2021?

- Ans
- 1. Prof. Ramesh Chand
  - 2. Prof. Suresh Pal
  - 3. Prof. Vijay P Sharma
  - 4. Prof. Gopal Naik

Q.45 Which of the following statements about the Rajasthan Minimum Guaranteed Income Bill 2023 is INCORRECT?

- Ans
- 1. The bill promises 125 days of work a year for all families in the state.
  - 2. The bill guarantees a minimum pension of ₹1,000 per month to the elderly, specially abled, widows and single women.
  - 3. The minimum pension under the bill will increase by 15% every year.
  - 4. The bill offers free education to all residents of Rajasthan.

Q.46 Mango shower is a term used for \_\_\_\_\_.

- Ans
- 1. monsoon showers
  - 2. pre-monsoon showers
  - 3. post-monsoon showers
  - 4. winter showers

Q.47 Which months are known for the season of retreating monsoon in India?

- Ans
- 1. March and April
  - 2. October and November
  - 3. May and June
  - 4. January and February

Q.48 Which of the following fundamental rights has been amended as a constitutional right in the form of Article 300A in the new Chapter IV Part XII of the Indian Constitution?

- Ans
- 1. Cultural and Educational Rights
  - 2. Right to Freedom of Religion
  - 3. Right against Exploitation
  - 4. Right to Property

Q.49 Match the following.

A	Propene	1	Unsaturated 3 carbon chains with double bond
B	Propyne	2	Unsaturated 3 carbon chains with triple bond
C	Propane	3	Saturated 3 carbon bonds

- Ans
- 1. A-3, B-1, C-2
  - 2. A-1, B-2, C-3
  - 3. A-3, B-2, C-1
  - 4. A-2, B-1, C-3

Q.50 Boron is the only metalloid of which group of the periodic table?

- Ans
- 1. Group 10
  - 2. Group 16
  - 3. Group 5
  - 4. Group 13

Section : General Engineering Civil and Structural

Q.1 For a balanced beam section, the limit state is reached when:

- Ans
- 1. there is the simultaneous crushing of concrete and yielding of steel
  - 2. there is the simultaneous crushing of concrete and breaking of steel
  - 3. there is the simultaneous yielding of concrete and breaking of steel
  - 4. there is the simultaneous yielding of both concrete and steel

Q.2 \_\_\_\_\_ shall be used to strength the beam against the maximum nominal shear stress in a RC beam.

- Ans
- 1. compression reinforcement
  - 2. shear reinforcement
  - 3. tension reinforcement
  - 4. side reinforcement

Q.3 Laminated wood offers several advantages over solid wood. Which of the following is NOT an advantage of laminated wood?

- Ans
- 1. Since laminated wood is glued, wood of only large dimensions can be used, which increases the amount of waste.
  - 2. Individual boards, which are used in laminated wood due to their relative thinness, can be properly dried without checking (cracking) and defects, such as knots, can be removed.
  - 3. Structures can be designed with laminated wood based on the required strength and low-grade wood can be positioned accordingly.
  - 4. It can be used to fabricate large members that are impossible to be made from solid wood.

Q.4 Which property of concrete makes it advantageous for construction of bridges?

- Ans
- 1. Low tensile strength
  - 2. Low durability
  - 3. High compressive strength
  - 4. Low thermal conductivity

Q.5 A direct runoff hydrograph of triangular shape, caused by a storm, has a time base of 100 hours and the peak flow of 50 cumec occurring at 30 hours from the start. If the catchment area is 150 km<sup>2</sup>, the rainfall excess of the storm was \_\_\_\_\_.

- Ans
- 1. 6.8 cm
  - 2. 5.6 cm
  - 3. 7.2 cm
  - 4. 6 cm

Q.6 In the direct shear test conducted on soils, a proving ring is used to \_\_\_\_\_.

- Ans
- 1. measure the magnitude of shear load
  - 2. measure vertical strain
  - 3. measure horizontal stress
  - 4. measure horizontal strain

Q.7 For a project, which of the following estimate is accorded sanction in a Technical sanction ?

- Ans
- 1. Preliminary estimate
  - 2. Abstract estimate
  - 3. Approximate estimate
  - 4. Detailed estimate

Q.8 Select the option that is appropriate regarding the following two statements pertaining to lining of canals, labelled as Assertion and Reason.

**Assertion:** The expenditure on lining depends on the availability of construction materials and transportation charges.

**Reason:** To reduce the expenditure on lining, materials which are available in the vicinity of the project should be utilised.

- Ans
- 1. Both Assertion and Reason are false.
  - 2. Assertion is true, but Reason is false.
  - 3. Both Assertion and Reason are true, but Reason is not the correct explanation of Assertion.
  - 4. Both Assertion and Reason are true and Reason is the correct explanation of Assertion.

Q.9 A soil has a liquid limit of 40% and its plasticity index is 10%. The percentage passing through a 4.75 mm sieve is 60% and the percentage passing through a 75 micron sieve is 45%. The soil can be classified as:

- Ans
- 1. SM-SC
  - 2. GM
  - 3. GC
  - 4. SM

Q.10 Find the correct statement regarding the assumption of limit state design under compression member as per IS 456:2000.

- Ans
- 1. The minimum compressive strain in concrete in axial compression is 0.002.
  - 2. The maximum compressive strain in concrete in axial compression is 0.02.
  - 3. The minimum compressive strain in concrete in axial compression is 0.0002.
  - 4. The maximum compressive strain in concrete in axial compression is 0.002.

Q.11 In the case of preliminary estimate prepared per unit basis, the service units to be considered for a school and hospital are respectively \_\_\_\_\_.

- Ans
- 1. bench and bed
  - 2. classroom and bed
  - 3. classroom and ward
  - 4. bench and ward

Q.12 A catchment area of 10 km<sup>2</sup> has recorded a rainfall of 25 mm/h. Assuming a runoff co-efficient of 0.3, the peak discharge from the catchment using the rational method is \_\_\_\_\_.

- Ans
- 1. 20.83 cumec
  - 2. 18.36 cumec
  - 3. 26.56 cumec
  - 4. 24.6 cumec

Q.13 Which of the following statements represent(s) advantages of the separate system of sewerage?

Statement I: The load on treatment units becomes less.

Statement II: Sewers are large in diameter.

Statement III: Maintenance costs are reasonable.

Ans  1. Only III

2. Only I

3. Only II and III

4. Only II

Q.14 Which of the following options serves all the three objectives mentioned below?

I: To promote human health

II: To provide a cleaner environment

III: To break the cycle of diseases

Ans  1. Drainage system

2. Scavenging system

3. Sanitary system

4. Distribution system

Q.15 In case of absorption test on burnt clay building bricks as per IS 3495 (part 2);1992, bricks shall be soaked in cold water for a duration of \_\_\_\_\_ .

Ans  1. 24 hours

2. 16 hours

3. 9 hours

4. 12 hours

Q.16 Which of the following methods of transportation of concrete is useful for transporting the concrete to a relatively greater distance from batching plant?

Ans  1. Pump and pipe line

2. Transit mixer

3. Crane and bucket method

4. Wheel barrow

Q.17 Why are air vessels fitted in reciprocating pumps?

Ans  1. For faster discharge

2. For increasing the speed of rotation of the crank

3. To reduce the head loss due to friction in suction and delivery pipe

4. For increasing the velocity of discharge

Q.18 Based on Allen-Hazens experiments, the co-efficient of permeability  $k$  (cm/s) is related to the effective size of soil  $D_{10}$  (cm) as \_\_\_\_\_. (where  $C$  is a constant with a value between 100 and 150).

Ans  1.  $k = CD_{10}^2$

2.  $k = C^2D_{10}$

3.  $k = D_{10}/C^2$

4.  $k = C/D_{10}^2$

Q.19 Identify the INCORRECT statement regarding ready-mix concrete (RMC). Consider that ordinary Portland cement is used for making RMC.

- Ans
- 1. The mix design of RMC is tailor made to suit the placing methods of the contractor.
  - 2. Ready-mix concrete in wet condition is transported by using a transit mixer from the batching plant to the construction site.
  - 3. Ready-mix concrete increases the speed of construction.
  - 4. Ready-mix concrete packed in bags should be added with a hydration activator while mixing with water.

Q.20 The loss of life is maximum if the flood water suddenly enters the inhabited areas at night. The loss of life during the floods is considered as \_\_\_\_\_ loss.

- Ans
- 1. huge and tangible
  - 2. measurable
  - 3. tangible
  - 4. intangible

Q.21 Which of the following is/are the objectives of road sign?

- i. Promote road safety
- ii. Promote efficient movement of vehicles
- iii. Increase design speed
- iv. Calculate traffic volume
- v. Provide warning for safe movement

- Ans
- 1. i, ii, iii and v
  - 2. Only i, ii and v
  - 3. Both iii and v
  - 4. Only i

Q.22 As per IS 456 : 2000, the design strength of a short axially loaded compression member is expressed as \_\_\_\_\_. Where,  $f_y$ =characteristic strength of the compression reinforcement,  $A_{sc}$ =area of longitudinal reinforcement for columns,  $f_{ck}$ =characteristic compressive strength of the concrete,  $A_c$ =Area of concrete.

- Ans
- 1.  $[0.87 f_{sc}A_{sc} + f_{ck}A_c]$
  - 2.  $[0.45 f_{sc}A_{sc} + f_{ck}A_c]$
  - 3.  $[0.87 f_{ck}A_c + f_{sc}A_{sc}]$
  - 4.  $[0.4f_{ck}A_c+0.67f_yA_{sc}]$

Q.23 In an irrigated field, the crop requires 60 cm of water in 15 days, while the effective rainfall during that period is recorded as 15 cm. Find the duty at the head of field. Assume no losses

- Ans
- 1. 288 ha/cumec
  - 2. 278 ha/cumec
  - 3. 298 ha/cumec
  - 4. 268 ha/cumec

Q.24 Which of the following can be used as an alternative for the blast furnace in the steel manufacturing industry for energy saving?

- Ans
- 1. Pulverised coal injection
  - 2. Dry quenching
  - 3. Heat recovery from hot sinter
  - 4. Programmed coke heating

Q.25 Identify different stages in the treatment of sewage.

- Ans
- 1. Disinfection and secondary treatment
  - 2. Primary treatment and disinfection
  - 3. Primary treatment and secondary treatment
  - 4. Primary treatment, secondary treatment and disinfection

Q.26 \_\_\_\_\_ are popularly known as white ants, though they are in no way related to ants.

- Ans
- 1. Termites
  - 2. Bacteria
  - 3. Flies
  - 4. Viruses

Q.27 Which of the following term is used to express the process of water coming out from the concrete and accumulate at the surface of concrete during compaction?

- Ans
- 1. Efflorescence
  - 2. Seepage
  - 3. Bleeding
  - 4. Permeability

Q.28 Which of the following statements about the Noise Pollution (Regulation and Control) Rules, 2000, under the Environment Protection Act, 1986, is INCORRECT?

- Ans
- 1. There are three categories of zones.
  - 2. Day time shall mean the period from 6.00 a.m. to 10.00 p.m.
  - 3. The day time and night time limits of noise in commercial areas are 75 dB and 70 dB, respectively.
  - 4. Silence zone is an area comprising not less than 100 m around hospitals, etc.

Q.29 In the laboratory determination of California Bearing Ratio (CBR) test on soils as per IS : 2720(Part 16) – 1987, the CBR values are usually reported for penetration values of :

- Ans
- 1. 5.0 mm, 7.5 mm
  - 2. 1.5 mm, 2.5 mm
  - 3. 2.5 mm, 5.0 mm
  - 4. 3.5 mm, 5.0 mm

Q.30 When pipes of different diameters are connected in series from end to end to form a pipe line, the total head loss developed is equal to\_\_\_\_\_

- Ans
- 1. sum of major head losses in each pipe
  - 2. Sum of local head losses only
  - 3. Zero
  - 4. Sum of local head losses and major head losses in each pipe

Q.31 The canal fall with a combination of a convex curve and a concave curve, which is provided for carrying the canal water from a higher level to a lower level, is known as \_\_\_\_\_.

- Ans
- 1. rapid fall
  - 2. ogee fall
  - 3. stepped fall
  - 4. sarda fall

Q.32 As per IS 1077:1992, the size of standard modular burn clay building bricks is\_\_\_

- Ans
- 1. 19 cm × 9 cm × 9 cm
  - 2. 25 cm × 19 cm × 9 cm
  - 3. 19 cm × 18 cm × 18 cm
  - 4. 22 cm × 15 cm × 10 cm

Q.33 Which of the following pairs of parameters of drinking water and their desirable limits is correctly matched (as per IS 10500: 1991)?

- Ans
- 1. Chlorides – 250 mg/l
  - 2. pH – 7
  - 3. Fluorides – 0.5 mg/l
  - 4. Iron – 0.5 mg/l

Q.34 Identify the correct characteristic feature of scale chosen to draw profile of ground using profile leveling data

- Ans
- 1. Both horizontal and vertical distances are always plotted to 1 : 1 scale.
  - 2. Horizontal distances are exaggerated as compared to vertical distances.
  - 3. Vertical distances are exaggerated as compared to horizontal distances.
  - 4. Both horizontal and vertical distances are plotted to the same scale.

Q.35 What will be the discharge of a single-acting pump if it has one cylinder of area 0.5 m<sup>2</sup> and stroke of length 20 cm and if the pump has 180 rpm of speed?

- Ans
- 1. 0.25m<sup>3</sup>/s
  - 2. 0.3 m<sup>3</sup>/s
  - 3. 0.1m<sup>3</sup>/s
  - 4. 0.2 m<sup>3</sup>/s

Q.36 Which of the following property of water makes the raindrops to form roughly spherical structure?

- Ans
- 1. air resistance
  - 2. atmospheric pressure
  - 3. surface tension
  - 4. Acceleration due to gravity

Q.37 Which of the following statements about soil pollution is INCORRECT?

- Ans
- 1. The area treatment method to prevent soil erosion involves treating the natural water courses.
  - 2. Irrigation water can cause salinisation of soil.
  - 3. In temperate regions, DDT has a half-life of 10–15 years.
  - 4. Storing surplus rainwater by constructing bunds, ponds, etc. belongs to the category of area treatment method.

Q.38 Which of the given procedures should be followed before applying paint onto different components of a building?

- i) Chalking
- ii) Flaking
- iii) Removing blisters
- iv) Surface wetting

- Ans
- 1. (i), (ii) and (iii)
  - 2. (ii) and (iii)
  - 3. Only (i)
  - 4. All of (i), (ii), (iii) and (iv)

Q.39 Select the option that is appropriate regarding the following two statements labelled Assertion and Reason.  
Assertion: Proper deep ploughing, which is done by tractors, requires overall less quality of water and hence, the duty is high.  
Reason: Ploughing should be done properly and deeply so that the moisture-retaining capacity of the soil is increased.

- Ans
- 1. Both Assertion and Reason are false.
  - 2. Both Assertion and Reason are true, but Reason is not the correct explanation of Assertion.
  - 3. Assertion is true, but Reason is false.
  - 4. Both Assertion and Reason are true and Reason is the correct explanation of Assertion.

Q.40 Which of the following is the hazardous waste produced by petroleum refining industries?

- Ans
- 1. Tarry residues
  - 2. Cyanide-containing sludge
  - 3. Lead ash
  - 4. Spent clay-containing oil

Q.41 Calculate the design stress for a steel grade Fe-415 after applying necessary factor of safety, in case of design of RCC members in accordance with limit state design.

- Ans
- 1. 435 N/mm<sup>2</sup>
  - 2. 217.5 N/mm<sup>2</sup>
  - 3. 415 N/mm<sup>2</sup>
  - 4. 361.05 N/mm<sup>2</sup>

Q.42 The distance travelled by a vehicle after the application of brakes to a dead stop position is known as:

- Ans
- 1. braking distance
  - 2. distance to react
  - 3. stopping distance
  - 4. deceleration distance

Q.43 If the value of Poisson's ratio for a material is given as 0.35, then the elastic constants are related to each other as:

- Ans
- 1.  $G = 2.7E$
  - 2.  $K = 0.9E$
  - 3.  $E = 2.7G$
  - 4.  $E = 1.3G$

Q.44 If 90% of soil particles got retained over 2 mm sieve and 50% of soil particles got retained over 4.75 mm sieve, then the effective diameter of the soil will be:

- Ans
- 1. 2 mm
  - 2. 6.75 mm
  - 3. 4.75 mm
  - 4. 1.25 mm

Q.45 The biological treatment techniques used can be classified into attached growth processes and suspended growth processes. Which of the following treatments is classified under attached growth processes?

- Ans
- 1. Sludge digestion system
  - 2. Activated sludge process
  - 3. Rotating biological conductor
  - 4. Aerated lagoon



Q.46 The tangent drawn to the instantaneous velocity in a flow field is called:

- Ans
- 1. timeline
  - 2. pathline
  - 3. streamline
  - 4. streakline

Q.47 Modern electronic distance measurement (EDM) measures distance by \_\_\_\_\_

- Ans
- 1. measurement by invar tape
  - 2. measurement of velocity of infra-red signals
  - 3. measurement of wave travel time
  - 4. measurement of phase difference between transmitted and reflected signals

Q.48 Plinth area is calculated for the covered area by taking \_\_\_\_\_.

- Ans
- 1. both the external and internal dimension of the building at the floor level
  - 2. centre to centre length at floor level
  - 3. internal dimensions of the building at floor level
  - 4. external dimensions of the building at the floor level

Q.49 Let P and Q be the reference points on the ground. You have to establish a point R. Which of the following methods conforms to the fundamental principles of surveying?

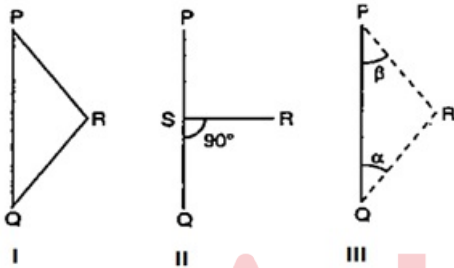

- Ans
- 1. Only I
  - 2. I, II and III
  - 3. Only III
  - 4. Only I and II

Q.50 Which of the following indicates a preliminary stage of dead knot, where the fibres of knot are not firmly held in the surrounding wood?

- Ans
- 1. Dead knot
  - 2. Round knot
  - 3. Loose knot
  - 4. Tight knot

Q.51 For a given open channel, if the Chezy's coefficient (C) is decreased, then how will it affect the discharge (Q) of the flow?

- Ans
- 1. Q will increase
  - 2. Q will decrease
  - 3. Q will remain constant
  - 4. Q will become zero

Q.52 A school building of 15 classrooms is to be constructed and the cost of construction of the school in terms of per classroom is ₹1,50,000. Calculate the approximate cost of the proposed school building.

- Ans
- 1. ₹30,00,000
  - 2. ₹42,50,000
  - 3. ₹22,50,000
  - 4. ₹20,00,000

Q.53 Identify the canal regulation structure, used for closing the supply to the downstream of the parent canal during repairs.

- Ans
- 1. cross regulator
  - 2. stream regulator
  - 3. head regulator
  - 4. distributary regulator

Q.54 Which of the following is/are the main advantage of using a dumpy level in surveying?

- i) Simple to use
- ii) Provides accurate level of reading
- iii) Can be used at night, without light

- Ans
- 1. Both i and ii
  - 2. Only ii
  - 3. Only i
  - 4. Only iii

Q.55 Following IS : 2502-1963, determine the approximate total length of bar of 6 mm diameter, measured along centre line, for the stirrup shown in Figure. (Note : Take the given stirrup dimensions in Figure as internal).

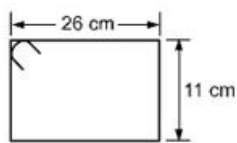

- Ans
- 1. 0.884 m
  - 2. 0.448 m
  - 3. 0.848 m
  - 4. 0.440 m

Q.56 The soil has a liquid limit of 50 %. Following the A-line, in the plasticity chart as per IS : 1498 – 1970, the corresponding plastic limit is :

- Ans
- 1. 28.1%
  - 2. Insufficient data
  - 3. 25%
  - 4. 21.9%

Q.57 Which of the following statements regarding the vertical circle of a theodolite is correct?

- Ans
- 1. Both the graduation circle and the Vernier scale move with the telescope.
  - 2. The Vernier scale is fixed, but the graduation circle moves with the telescope.
  - 3. Both the graduation circle and the Vernier scale are fixed, while the telescope moves.
  - 4. The graduation circle is fixed, but the Vernier scale moves with the telescope.

Q.58 The following are different factors that affect the diurnal variation in magnetic declination. The condition which may result in the maximum variation is \_\_\_\_\_.

- Ans
- 1. at the Equator during winter
  - 2. at the Magnetic Poles during winter
  - 3. at the Equator during summer
  - 4. at the Magnetic Poles during summer

Q.59 Which of the piles is used for compacting loose granular soil?

- Ans
- 1. End bearing piles
  - 2. Tension piles
  - 3. Compaction piles
  - 4. Friction piles

Q.60 Which of the following methods make use of infra-red lamp in the determination of water content of soils ?

- Ans
- 1. Torsional balance method
  - 2. Calcium carbide method
  - 3. Alcohol method
  - 4. Pycnometer method

Q.61 A rectangular RCC beam section having a width of 200 mm and depth of 300 mm is subjected to a factored shear force of 60 kN. Determine the nominal shear stress acting in the section if the effective cover is 50 mm and grade of concrete is M 20 and the grade of steel is Fe 415.

- Ans
- 1. 1.4 N/mm<sup>2</sup>
  - 2. 1.2 N/mm<sup>2</sup>
  - 3. 1 N/mm<sup>2</sup>
  - 4. 0.86 N/mm<sup>2</sup>

Q.62 The effective length ratio 'K' for a column in frame with no sway is limited between:

- Ans
- 1. 0 and 0.5
  - 2. 0.25 and 0.5
  - 3. 0 and 1.0
  - 4. 0.5 and 1.0

Q.63 Timber which are slow and difficult to season free from defects, are classified as based upon their behaviour to cracking and splitting during normal air-seasoning practice.

- Ans
- 1. Moderate refractory
  - 2. High refractory
  - 3. Low refractory
  - 4. Null refractory

Q.64 The right limb of height  $h_2$  in the simple u tube manometer containing mercury is open to atmosphere, while the left limb of height  $h_1$  is connected to pipe in which a liquid of specific gravity 1 is flowing with uniform speed with  $h_1 < h_2$ . This condition gives \_\_\_\_\_ kind of pressure.

- Ans
- 1. atmospheric pressure
  - 2. positive gauge pressure
  - 3. absolute pressure
  - 4. negative gauge pressure

Q.65 Linear strains along X, Y and Z directions in an object with homogenous material are given as 0.05, 0.10 and 0.10, respectively. The size of the object before deformation was 20 cm × 10 cm × 10 cm. Determine the volumetric strain and change in volume of the material after deformation.

- Ans
- 1. Volumetric strain = 0.25, change in volume =  $5 \times 10^3 \text{ mm}^3$
  - 2. Volumetric strain = 0.25, change in volume = 500  $\text{mm}^3$
  - 3. Volumetric strain = 0.3, change in volume =  $60 \times 10^3 \text{ mm}^3$
  - 4. Volumetric strain = 0.7, change in volume = 1400  $\text{cm}^3$

Q.66 Which of the following type of cement is preferred for concrete making which is used in construction of sewage treatment plants located where, soil is infested with sulphates?

- Ans
- 1. Rapid-hardening cement
  - 2. Portland slag cement
  - 3. Extra rapid-hardening cement
  - 4. Sulphate-resisting cement

Q.67 The result of the soundness test of 53-grade Portland cement conducted by using Le Chatelier's apparatus shall NOT exceed \_\_\_\_\_ mm.

- Ans
- 1. 10
  - 2. 5
  - 3. 12
  - 4. 15

Q.68 If the velocity of the fluid does NOT change with respect to time, the flow is said to be a/an:

- Ans
- 1. non-uniform flow
  - 2. steady flow
  - 3. unsteady flow
  - 4. uniform flow

Q.69 In which type of dressing of stone are about 1 cm vertical or horizontal grooves sunk with a chisel having its shape as a hollow semi-circle?

- Ans
- 1. Reticulated finish
  - 2. Punched dressing
  - 3. Close picked and fine tooling
  - 4. Boasted or droved finish

Q.70 Which of the following is not a functional characteristics of kerbs used in road construction?

- Ans
- 1. Presents a more finished appearance
  - 2. acts as a boundary between the pavement and the footpath.
  - 3. Protects the pavement edge
  - 4. provides cross slope to the pavement so that immediate drainage of water takes place

Q.71 Streams passing through peaty land possess \_\_\_\_\_ colour.

- Ans
- 1. brown
  - 2. yellow
  - 3. black
  - 4. blue

Q.72 Which of the following factors is not accounted in the cost estimation of a reinforced concrete (RC) water tank?

- Ans
- 1. Thickness of RC slab and wall
  - 2. Length of water tank
  - 3. height of water tank
  - 4. Density of water

Q.73 A Moody diagram represents \_\_\_\_\_ as a function of Reynolds number, in a pipe flow.

- Ans
- 1. Length of pipe
  - 2. Kinetic head
  - 3. friction factor
  - 4. Flow velocity

Q.74 What is the best side slope (n) for the most economic trapezoidal channel having depth d and base width b?

- Ans
- 1.  $\sqrt{3}$
  - 2.  $\sqrt{2}$
  - 3.  $\frac{1}{\sqrt{3}}$
  - 4.  $\frac{1}{\sqrt{2}}$

Q.75 A cantilever beam subjected to two different point loads is shown in the figure. Calculate the slope at fixed end A. Take 'EI' as constant throughout its length.

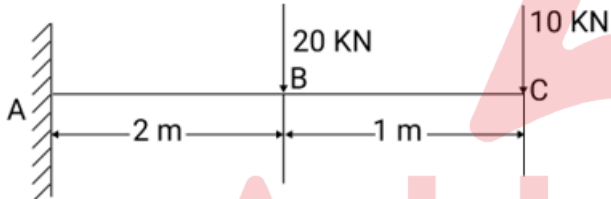

- Ans
- 1.  $\frac{105}{EI}$
  - 2.  $\frac{13.33}{EI}$
  - 3. Zero
  - 4.  $\frac{85}{EI}$

Q.76 Which of the following stress distribution diagrams represents the condition where the intensity of direct stress is less than the intensity of bending stress?

Where  $\sigma_{\min}$  is minimum resultant stress and  $\sigma_{\max}$  is maximum resultant stress.

Ans

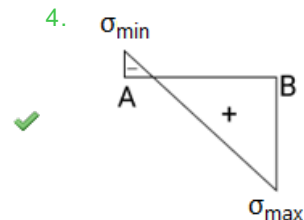
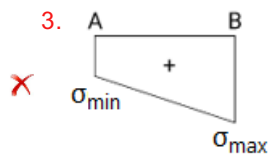
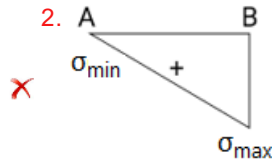
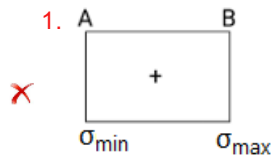

Q.77 Which of the following conditions followed in making concrete reduces the workability of concrete?

- Ans
- X 1. Use of superplasticisers
  - ✓ 2. Higher aggregate-cement ratio in concrete
  - X 3. Higher water-cement ratio in concrete
  - X 4. Use of round aggregates

Q.78 The specific gravity of most of the stones lies between \_\_\_\_\_.

- Ans
- X 1. 1 and 2
  - ✓ 2. 2 and 3
  - X 3. 3 and 3.5
  - X 4. 3.5 and 4

Q.79 Which of the following is not a primary objective of design of railway track geometric?

- Ans
- X 1. Achieving maximum speed
  - ✓ 2. Carrying only light axle load
  - X 3. Smooth running
  - X 4. Safety

Q.80 The curve that is generally used to avoid the obstructions like hard rocks, deep cuttings, soft gradients is called \_\_\_\_\_.

- Ans
- 1. transitional curve
  - 2. compound curve
  - 3. parabolic curve
  - 4. simple curve

Q.81 The suitability for a particular type of foundation does NOT depend upon the \_\_\_\_\_ .

- Ans
- 1. Optimum moisture content (OMC) of soil
  - 2. type of soil
  - 3. depth of ground water table
  - 4. magnitude of loads

Q.82 The markings on the kerbs are painted with which colour to increase user visibility?

- Ans
- 1. Alternate white and yellow
  - 2. Alternate black and white
  - 3. Yellow Only
  - 4. Black Only

Q.83 As per Euler's theory, buckling of the long column occurs when

(Given,  $P$  = Applied axial load and  $P_{cr}$  = Crippling load by Euler's theory)

- Ans
- 1.  $P > P_{cr}$
  - 2.  $P = P_{cr}$
  - 3.  $P$  is of any value
  - 4.  $P < P_{cr}$

Q.84 Which of the following properties should the subgrade soil have in order to be used as highway material?

- Ans
- 1. Large changes in volume under adverse conditions of weather, stability
  - 2. Large changes in volume under adverse conditions of weather, compressibility, good drainage
  - 3. Ease of compaction, compressibility, stability
  - 4. Stability, incompressibility, good drainage

Q.85 The number of days between sowing and harvesting of a crop is called the crop period. Base period is the number of days between the first watering at the time of sowing and the last water before harvesting of a crop. If the base period and the crop period are compared, \_\_\_\_\_.

- Ans
- 1. the base period is slightly more than the crop period
  - 2. the base period is much higher than the crop period
  - 3. the base period is equal to the crop period
  - 4. the base period is slightly less than the crop period

Q.86 As per IS: 1562-1962, the 'Diagonal Scale - A' has a graduated length of \_\_\_\_\_.

- Ans
- 1. 1.5 cm
  - 2. 15 cm
  - 3. 150 cm
  - 4. 0.15 cm

Q.87 A reinforced concrete slab must be designed as \_\_\_\_\_ in order to develop complete the yield line pattern

- Ans
- 1. under reinforced
  - 2. balanced reinforced
  - 3. over reinforced
  - 4. shear reinforced

Q.88 Which of the following methods used for finding the slope and deflection of beams is also called the 'method of singularity function'?

- Ans
- 1. Moment area method
  - 2. Conjugate beam method
  - 3. Macaulay's method
  - 4. Mohr's Theorem method

Q.89 Which of the following estimates mostly resembles a detailed estimate ?

- Ans
- 1. Rough estimate
  - 2. Quantity estimate
  - 3. Item rate estimate
  - 4. Annual maintenance estimate

Q.90 Which of the following statements about the secondary treatment of sewage is INCORRECT?

- Ans
- 1. Secondary treatment methods are broadly divided into filtration and activated sludge process.
  - 2. Activated sludge is biologically active.
  - 3. Primary treatment of sewage is not essential for efficient working of contact beds.
  - 4. Oxidation of organic matter occurs in trickling filters under aerobic conditions.

Q.91 Which of the following statements is correct about measurement of the vertical angle while using a total station?

- Ans
- 1. It is usually measured as a zenith angle.
  - 2. An electronic digital theodolite is not able to measure the vertical angle.
  - 3. It is measured relative to the horizontal direction.
  - 4. It is measured from the instrument north in the horizontal plane.

Q.92 Match the following markings drawn on the carriage way with their significances.

S. No.	Type of Line	S. No.	Significance
A	Double longitudinal solid lines	1	Guiding and regulating line
B	Broken longitudinal lines	2	Edge line
C	Solid longitudinal lines	3	Indicate centre line or lane-marking for multi-lane roads
		4	Indicate maximum restriction and are only to be crossed in case of emergency

- Ans
- 1. A-1, B-3, C-4
  - 2. A-2, B-2, C-4
  - 3. A-4, B-3, C-1
  - 4. A-3, B- 4, C-1



Q.93 Which of the following is a type of detailed estimate?

- Ans
- 1. Service unit method
  - 2. Plinth area rate method
  - 3. Cubical content method
  - 4. Revised estimate

Q.94 Among the following factors that can cause an error during distance measurement in chaining, the compensating error is caused by \_\_\_\_\_.

- Ans
- 1. bad ranging
  - 2. variation in temperature
  - 3. sag in chain
  - 4. careless holding and marking

Q.95 As per IS 2770(part I), the load at failure in a pull out test was found to be 180 kN. Calculate the bond strength if the bar diameter is 20 mm and its embedded length into concrete is 300 mm.

- Ans
- 1.  $\frac{10}{\pi}$  N/mm<sup>2</sup>
  - 2.  $\frac{30}{\pi}$  N/mm<sup>2</sup>
  - 3.  $\frac{15}{\pi}$  N/mm<sup>2</sup>
  - 4.  $\frac{50}{\pi}$  N/mm<sup>2</sup>

Q.96 As per IS 456:2000, the minimum cross sectional area of longitudinal reinforcement(irrespective of load requirement) in a RCC column of size 150x300 mm shall NOT be less than \_\_\_\_\_. Consider the limit state method of design.

- Ans
- 1. 360 mm<sup>2</sup>
  - 2. 780 mm<sup>2</sup>
  - 3. 440 mm<sup>2</sup>
  - 4. 240 mm<sup>2</sup>

Q.97 Which of the following type of coarse aggregate is preferred in road construction, so that greatest density of road layer is achieved?

- Ans
- 1. Any type of aggregates
  - 2. porous aggregates
  - 3. Single-size aggregates
  - 4. All-in aggregates

Q.98 What is the maximum limit of grade compensation for the gradient on the horizontal curve along highways, if 'R' is the radius of the circular curve in metres?

- Ans
- 1.  $\frac{300}{R}$
  - 2.  $\frac{150}{R}$
  - 3.  $\frac{50}{R}$
  - 4.  $\frac{75}{R}$

Q.99 Assuming the stress block diagram of the rectangular concrete beam section as per IS 456-2000, the depth of the centre of compressive force measured from the neutral axis is given by: (Assuming  $X_u$  as the depth of neutral axis from top compression fiber)

- Ans
- 1.  $0.36 X_u$
  - 2.  $0.58 X_u$
  - 3.  $0.42 X_u$
  - 4.  $0.67 X_u$

Q.100 Bernoulli's equation is applicable for:

- Ans
- 1. viscous fluids
  - 2. rotational fluids
  - 3. compressible fluids
  - 4. incompressible fluids



## Junior Engineer Civil Mechanical and Electrical Examination 2024 Paper I

Exam Date	06/06/2024
Exam Time	1:00 PM - 3:00 PM
Subject	Junior Engineer 2024 Electrical Paper I

### Section : General Intelligence and Reasoning

Q1 What should come in place of the question mark (?) in the given series based on the English alphabetical order?  
GCR, HEU, IGX, JIA, ?

- Ans
- 1. KKD
  - 2. GLC
  - 3. MNB
  - 4. JMC

Q2 What will come in place of the question mark (?) in the following equation if '+' and 'x' are interchanged?  
 $104 \times 8 \div 11 + 33 - 47 = ?$

- Ans
- 1. 124
  - 2. 135
  - 3. 129
  - 4. 137

Q3 What will come in the place of the question mark (?) in the following equation, if '+' and '÷' are interchanged and 'x' and '-' are interchanged?  
 $24 + 6 - 11 \times 15 \div 12 = ?$

- Ans
- 1. 41
  - 2. 51
  - 3. 61
  - 4. 31

Q4 EJFI is related to KPLO in a certain way based on the English alphabetical order. In the same way, INJM is related to OTPS. To which of the following is LQMP related, following the same logic?

- Ans
- 1. RWSV
  - 2. RWVS
  - 3. SWVR
  - 4. SWRV

Q5 Select the option in which the given figure is embedded (rotation is NOT allowed).

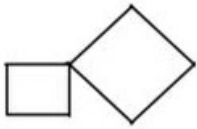

Ans

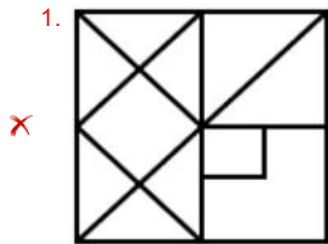

✗

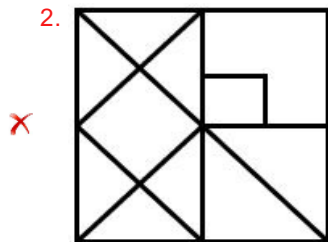

✗

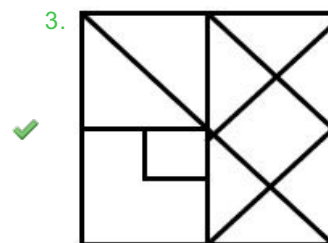

✓

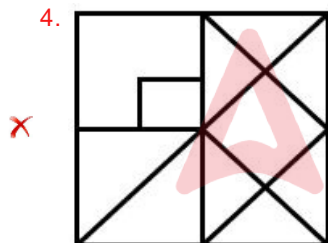

✗

Q6 OKRN is related to UQXT in a certain way based on the English alphabetical order. In the same way, KGNJ is related to QMTP. To which of the following is NJQM related, following the same logic?

- Ans
- ✗ 1. PTWS
  - ✗ 2. PTSW
  - ✗ 3. TPSW
  - ✓ 4. TPWS

Q7 What should come in place of the question mark (?) in the given series based on the English alphabetical order? ZBL, YDM, XFN, WHO, ?

- Ans
- ✗ 1. UJP
  - ✗ 2. RKL
  - ✗ 3. RKN
  - ✓ 4. VJP

Q8 UPSN is related to LGJE in a certain way based on the English alphabetical order. In the same way, WRUP is related to NILG. To which of the following is SNQL related, following the same logic?

- Ans
- ✓ 1. JEHC
  - ✗ 2. JECH
  - ✗ 3. EJCH
  - ✗ 4. EJHC

Q9 Select the figure from the options that can replace the question mark (?) and complete the given pattern.

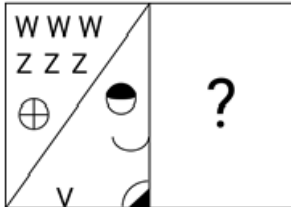

- Ans
- 1.
    - ✗
  - 2.
    - ✗
  - 3.
    - ✗
  - 4.
    - ✓

Q10 Read the given statements and conclusions carefully. Assuming that the information given in the statements is true, even if it appears to be at variance with commonly known facts, decide which of the given conclusions logically follow(s) from the statements.

Statements:

Some peacocks are robins.

All robins are sparrows.

All sparrows are owls.

Conclusions:

(I) No owl is a peacock.

(II) All sparrows are peacocks.

- Ans
- ✓ 1. Neither conclusion (I) nor (II) follows
  - ✗ 2. Only conclusion (II) follows
  - ✗ 3. Both conclusions (I) and (II) follow
  - ✗ 4. Only conclusion (I) follows

Q.11 Select the correct mirror image of the given figure when the mirror is placed at MN as shown below.

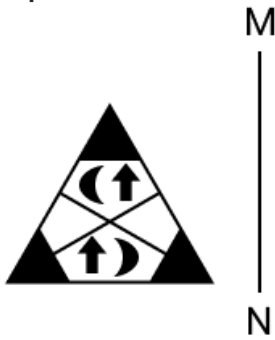

Ans 1.



2.



3.



4.



Q.12 A, B, C, D, E, F, and G are sitting around a circular table, facing the centre (not necessarily in the same order). Only 2 people sit between A and D when counted from the left of A. E sits to the immediate left of D. G sits to the immediate left of B. G is not an immediate neighbour of D. F sits to the immediate left of C. What is the position of B with respect to C?

Ans  1. Second to the right

2. Third to the left

3. Second to the left

4. Third to the right

Q.13 What should come in place of the question mark (?) in the given series?

4, 10, 28, 82, 244, ?

Ans  1. 714

2. 698

3. 680

4. 730

Q.14 AD 17 is related to CF 13 in a certain way. In the same way, EH 29 is related to GJ 25. To which of the following is IL 38 related, following the same logic?

- Ans
- 1. KN 34
  - 2. TZ 35
  - 3. XZ 34
  - 4. TY 35

Q.15 In a certain code language, 'CMPX' is coded as 'EONV' and 'WBFK' is coded as 'YDDI'. What is the code for 'XAOD' in the given language?

- Ans
- 1. YDND
  - 2. XDOD
  - 3. ZCMB
  - 4. XBMC

Q.16 The position(s) of how many letters will remain unchanged if each of the letter in the word AMPLIFY is arranged in the English alphabetical order?

- Ans
- 1. 1
  - 2. 2
  - 3. 3
  - 4. 4

Q.17 Select the option figure that will replace the question mark (?) in the figure given below to complete the pattern.

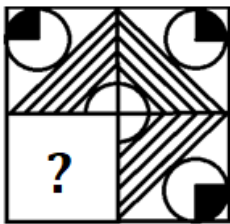

- Ans
- 1.
  - 2.
  - 3.
  - 4.

Q.18 If A means +, B means -, C means  $\times$  and D means  $\div$ , then what will come in place of the question mark (?) in the following equation?  
7 C 5 B 32 D 8 A 6 = ?

- Ans
- 1. 33
  - 2. 35
  - 3. 31
  - 4. 37

Q.19 Select the set in which the numbers are related in the same way as are the numbers of the following sets.  
(NOTE : Operations should be performed on the whole numbers, without breaking down the numbers into its constituent digits. E.g. 13 – Operations on 13 such as adding /subtracting /multiplying etc. to 13 can be performed. Breaking down 13 into 1 and 3 and then performing mathematical operations on 1 and 3 is not allowed)  
(23, 60)  
(13, 30)

- Ans
- 1. (9, 20)
  - 2. (10, 21)
  - 3. (11, 26)
  - 4. (12, 28)

Q.20 Select the set in which the numbers are related in the same way as are the numbers of the following sets.  
(NOTE: Operations should be performed on the whole numbers, without breaking down the numbers into its constituent digits. E.g., 13 – Operations on 13 such as adding/subtracting/multiplying etc. to 13 can be performed. Breaking down 13 into 1 and 3 and then performing mathematical operations on 1 and 3 is not allowed.)  
(12, 216, 6)  
(17, 408, 8)

- Ans
- 1. (8, 86, 12)
  - 2. (19, 190, 5)
  - 3. (14, 210, 5)
  - 4. (11, 220, 5)

Q.21 What should come in place of the question mark (?) in the given series based on the English alphabetical order?  
FDI, HEK, JFM, LGO, ?

- Ans
- 1. MHQ
  - 2. NHQ
  - 3. NOP
  - 4. MNQ

Q.22 What should come in place of the two question marks (?) in the given series in the same order?  
42, 43, 47, 56, ? , 97 , ?

- Ans
- 1. 72, 133
  - 2. 74, 135
  - 3. 71, 132
  - 4. 70, 131

Q.23 What should come in place of the question mark (?) in the given series based on the English alphabetical order?  
FOT, HLV, JIX, LFZ, NCB, ?

- Ans
- 1. MDE
  - 2. ODC
  - 3. NCB
  - 4. PZD



Q.24 23 is related to 69 following a certain logic. Following the same logic, 41 is related to 123. To which of the following is 52 related following the same logic?

(NOTE: Operations should be performed on the whole numbers, without breaking down the numbers into its constituent digits. E.g. 13 – Operations on 13 such as adding /subtracting /multiplying etc. to 13 can be performed. Breaking down 13 into 1 and 3 and then performing mathematical operations on 1 and 3 is not allowed.)

- Ans
- 1. 126
  - 2. 136
  - 3. 146
  - 4. 156

Q.25 How many triangles are there in the given figure?

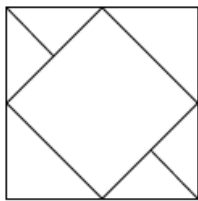

- Ans
- 1. 6
  - 2. 7
  - 3. 8
  - 4. 9

Q.26 In a certain code language, 'oh my god' is written as 'jk sr qw', and 'god is good' is written as 'dk zx sr'. How is 'god' written in that language?

- Ans
- 1. sr
  - 2. dk
  - 3. qw
  - 4. jk

Q.27 Select the correct option that indicates the arrangement of the following words in a logical and meaningful order.

1. Running
2. Crawling
3. Cycling
4. Walking
5. Driving

- Ans
- 1. 2, 5, 3, 1, 4
  - 2. 2, 3, 4, 5, 1
  - 3. 2, 1, 5, 4, 3
  - 4. 2, 4, 1, 3, 5

Q.28 18 is related to 126 following a certain logic. Following the same logic, 28 is related to 196. To which of the following is 48 related, following the same logic?

(NOTE: Operations should be performed on the whole numbers, without breaking down the numbers into its constituent digits. E.g. 13 – Operations on 13 such as adding/deleting/multiplying etc. to 13 can be performed. Breaking down 13 into 1 and 3 and then performing mathematical operations on 1 and 3 is not allowed.)

- Ans
- 1. 380
  - 2. 320
  - 3. 336
  - 4. 366

Q.29 Select the word-pair that best represents a similar relationship to the one expressed in the pair of words given below.

(The words must be considered as meaningful English words and must not be related to each other based on the number of letters/number of consonants/vowels in the word.)

Hematologists : Blood

- Ans
- 1. Oncologist : Cancer
  - 2. Cardiologist : Lungs
  - 3. Pathologist : Eye
  - 4. Nephrologist : Nervous System

Q.30 Select the option figure in which the given figure (X) is embedded as its part (rotation is NOT allowed).

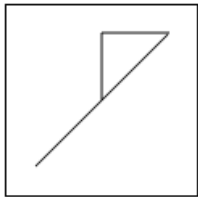

(X)

- Ans
- 1.
  - 2.
  - 3.
  - 4.

Q.31 Select the option in which the given figure is embedded (rotation is NOT allowed).

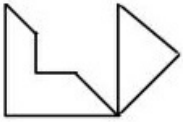

Ans

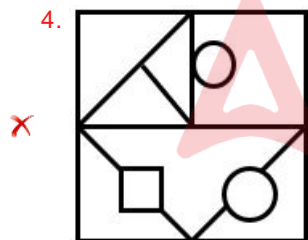
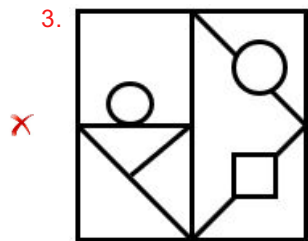
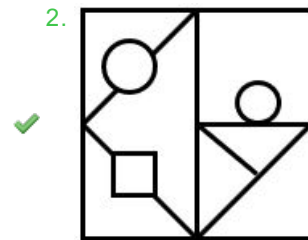
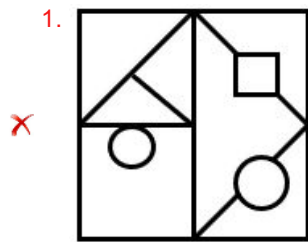

Q.32 In a certain code language,  
 'A + B' means 'A is the father of B',  
 'A - B' means 'A is the mother of B',  
 'A × B' means 'A is the wife of B', and  
 'A ÷ B' means 'A is the brother of B'.  
 How is P related to T if 'P ÷ Q - R × S + T'?

- Ans
- 1. Sister's husband
  - 2. Mother's brother
  - 3. Daughter's husband
  - 4. Mother's mother's brother

Q.33 Pillar E is to the east of Pillar D. Pillar A is to the west of Pillar D. Pillar B is to the north of Pillar A. Pillar C is to the south of Pillar A. What is the position of Pillar C with respect to Pillar E?

- Ans
- 1. South
  - 2. North-West
  - 3. North
  - 4. South-West

Q.34 Select the option in which the numbers share the same relationship as that shared by the given number triads.

39-36-33

67-64-61

(NOTE: Operations should be performed on the whole number, without breaking down the numbers into its constituent digits. E.g. 13- Operations on 13 such as adding/subtracting/multiplying etc. to 13 can be performed. Breaking down 13 into 1 and 3 and then performing mathematical operations on 1 and 3 is NOT allowed.)

- Ans
- 1. 98-95-92
  - 2. 100-94-90
  - 3. 120-116-105
  - 4. 64-54-50

Q.35 What will come in the place of the question mark (?) in the following equation, if '+' and 'x' are interchanged and '÷' and '-' are interchanged?

$$18 - 6 + 3 \times 20 \div 9 = ?$$

- Ans
- 1. 18
  - 2. 6
  - 3. 12
  - 4. 20

Q.36 E, F, G, H, I, J and K are sitting around a circular table with their backs facing the centre (not necessarily in the same order). J is sitting to the immediate left of G. K is sitting to the immediate right of E. H is sitting to the immediate right of K. I is sitting to the immediate right of H and immediate left of F. F is sitting to the immediate left of J. Who is an immediate neighbour of both E and J?

- Ans
- 1. H
  - 2. F
  - 3. G
  - 4. K

Q.37 Vikram walked 10 m towards the north. Then he turned right and walked 20 m. Then he turned right and walked 25 m. Then he turned left and walked 5 m. In what direction is he facing?

- Ans
- 1. South
  - 2. East
  - 3. West
  - 4. North

Q.38 Read the given statements and conclusions carefully. Assuming that the information given in the statements is true, even if it appears to be at variance with commonly known facts, decide which of the given conclusions logically follow(s) from the statements.

Statements: Some bowls are spoons. All spoons are plates.

Conclusion 1: Some spoons are bowls.

Conclusion 2: Some bowls are plates.

- Ans
- 1. None of the conclusions follow
  - 2. Only conclusion (2) follows
  - 3. Both conclusions (1) and (2) follow
  - 4. Only conclusion (1) follows

Q.39 CYTV is related to DZUW in a certain way based on the English alphabetical order. In the same way, GKOS is related to HLPT. To which of the following is BAHG related, following the same logic?

- Ans
- 1. CBIH
  - 2. ALPO
  - 3. MJGH
  - 4. PLIY

Q.40 In a certain code language, 'let us eat' is written as 'de hj kn' and 'let us play' is written as 'de kn cx'. How is 'eat' written in the given language?

- Ans
- 1. kn
  - 2. cx
  - 3. de
  - 4. hj

Q.41 What should come in place of ? in the given series based on the English alphabetical order?  
ITV, EPR, ALN, WHJ, ?

- Ans
- 1. QCG
  - 2. QBH
  - 3. SDF
  - 4. RCH

Q.42 What should come in place of the question mark (?) in the given series based on the English alphabetical order?

RDKW, WIPB, BNUG, GSZL, ?

- Ans
- 1. LKJU
  - 2. LXDE
  - 3. LXEQ
  - 4. LQSW

Q.43 Select the pair in which the numbers are related to each other in the same way as are the numbers of the given pairs.

(NOTE: Operations should be performed on the whole numbers, without breaking down the numbers into its constituent digits. E.g. 13 – Operations on 13 such as adding/deleting/multiplying etc. to 13 can be performed. Breaking down 13 into 1 and 3 and then performing mathematical operations on 1 and 3 is not allowed.)

(376, 234)

(354, 212)

- Ans
- 1. (281, 139)
  - 2. (294, 145)
  - 3. (328, 283)
  - 4. (349, 217)

Q.44 What should come in place of the question mark (?) in the given series?

146, 218, 340, 512, 734, ?

- Ans
- 1. 1134
  - 2. 1146
  - 3. 1006
  - 4. 1128

Q.45 The position of how many letters will remain unchanged if each of the letters in the word ADVISER is arranged in the English alphabetical order?

- Ans
- 1. One
  - 2. Two
  - 3. Three
  - 4. Four

Q.46 A, B, C, D, E, F and G are seven students from a college who appeared for an exam and scored different marks each. D scored the second highest marks. C scored immediately lower marks than D and immediately higher marks than F. E scored higher than only B. G scored less marks than four of the fellow students. Who scored the highest marks?

- Ans
- 1. A
  - 2. F
  - 3. B
  - 4. D

Q.47 Select the option that indicates the arrangement of the following words in meaningful and logical order.

1. Town
2. Village
3. Country
4. State
5. City

- Ans
- 1. 1, 3, 2, 4, 5
  - 2. 2, 1, 5, 4, 3
  - 3. 5, 1, 3, 2, 4
  - 4. 4, 1, 3, 2, 5

Q.48 ADVN is related to GJPH in a certain way based on the English alphabetical order. In the same way, WHUB is related to CNOV. To which of the following is RFMJ related, following the same logic?

- Ans
- 1. WMFE
  - 2. XMGE
  - 3. XLGD
  - 4. WLFD

Q.49 In a certain code language, 'bring him here' is coded as 'gy ct bo' and 'here is there' is coded as 'bo di yk'. How is 'here' coded in the given language?

- Ans
- 1. gy
  - 2. yk
  - 3. ct
  - 4. bo

Q.50 In a certain code language,  
'A + B' means 'A is the mother of B',  
'A - B' means 'A is the brother of B',  
'A × B' means 'A is the sister of B', and  
'A ÷ B' means 'A is the husband of B'.  
How is F related to Z if 'D ÷ F × G ÷ H + N - Z'?

- Ans
- 1. Mother's sister
  - 2. Husband's sister
  - 3. Sister
  - 4. Father's sister

Section : General Awareness

Q.1 Which of the following is the chemical formula of baking soda?

- Ans
- 1.  $\text{Na}_2\text{CO}_3 \cdot 10\text{H}_2\text{O}$
  - 2.  $\text{NaOH}$
  - 3.  $\text{CaOCl}_2$
  - 4.  $\text{NaHCO}_3$

Q.2 Which of the following is a colourless liquid whose formula is  $\text{CHCl}_3$  which evaporates rapidly and turns into gas?

- Ans
- 1. Ethanol
  - 2. Acetone
  - 3. Chloroform
  - 4. Ammonia

Q.3 The Government launched a 'Scheme for Expansion and Modernisation of Fire Services in the States' in July 2023 under the \_\_\_\_\_ for strengthening fire services in the States.

- Ans
- 1. National Disaster Response Fund (NDRF)
  - 2. National Disaster Relief Fund (NDRF)
  - 3. National Disaster Regulation Fund (NDRF)
  - 4. National Disaster Research Fund (NDRF)

Q.4 In which location were the inaugural National Games, previously known as the 'All India Olympic Games,' held before the independence of India?

- Ans
- 1. Lahore
  - 2. Poona
  - 3. Bombay
  - 4. Patiala

Q.5 Name a sublimable substance that can be converted into gas without passing through any intermediate liquid phase.

- Ans
- 1. Naphthalene
  - 2. Chalk Powder
  - 3. Alum
  - 4. Rust

Q.6 If wildlife sanctuaries are there to protect wild animals, then what do biosphere reserves protect?

- Ans
- 1. Native trees and plants
  - 2. Entire biodiversity of the area
  - 3. Forests of the area
  - 4. Water animals of the area

Q.7 Who can operate a blog?

- Ans
- 1. Individuals or small groups of people
  - 2. Only businesses
  - 3. Only large corporations
  - 4. Only individuals

Q.8 According to Census of India 2011, which of the following states recorded apopulation density of more than 1100 persons per km<sup>2</sup>?

- Ans
- 1. Rajasthan
  - 2. Punjab
  - 3. Kerala
  - 4. Bihar

Q.9 According to Census of India 2011, in which Union Territory was the highest population growth rate recorded?

- Ans
- 1. Dadra and Nagar Haveli
  - 2. Daman and Diu
  - 3. Andaman and Nicobar Islands
  - 4. Chandigarh

Q.10 Under which of the following ministries does 'VAIBHAV' Fellowship Programme announced by the Government of India in June 2023 ?

- Ans
- 1. Ministry of Urban Development
  - 2. Ministry of Human Resource Development
  - 3. Ministry of Science & Technology
  - 4. Ministry of Rural Development

Q.11 What makes countries near the equator hotter than those which are away from the equator?

- Ans
- 1. The equator is near the earth's core.
  - 2. The equator is a hot line.
  - 3. Areas near the equator have more volcanoes.
  - 4. Areas near the equator receive direct and more sunlight.

Q.12 What is the minimum age prescribed for a person to be eligible to become Vice-President of India?

- Ans
- 1. 25 years
  - 2. 30 years
  - 3. 35 years
  - 4. 40 years

Q.13 Which of the following trees is NOT found in the tropical evergreen forests of India?

- Ans
- 1. Rosewood
  - 2. Mahogany
  - 3. Ebony
  - 4. Amaltas

Q.14 The Rourkela Steel plant was set up in the year \_\_\_\_\_ in Odisha state.

- Ans
- 1. 1973
  - 2. 1969
  - 3. 1955
  - 4. 1959



Q.15 If a windmill farm has to be set up, setting up it near a coastal area seems like a good idea. What could be the main reason behind this?

- Ans
- 1. No water scarcity
  - 2. Heavily populated
  - 3. Land and sea breezes
  - 4. Chances of storms

Q.16 The Project Great Indian Bustard was launched by the Government of \_\_\_\_\_ in June 2013.

- Ans
- 1. Bihar
  - 2. Manipur
  - 3. Uttarakhand
  - 4. Rajasthan

Q.17 Which is the essential non-justiciable feature of the Indian Constitution associated with the welfare and well-being of the common man?

- Ans
- 1. Fundamental Rights
  - 2. Parliamentary Sovereignty
  - 3. Directive principles of State Policy
  - 4. Federalism

Q.18 Which of the following demineralises the enamel of the teeth?

- Ans
- 1. Acids produced by bacteria
  - 2. Soft toothbrush
  - 3. Toothpaste
  - 4. Saliva

Q.19 Some simple multicellular organisms reproduce by first splitting into multiple pieces. Then each of these pieces grow up into a new individual. What is this method of reproduction known as?

- Ans
- 1. Regeneration
  - 2. Binary fission
  - 3. Multiple fission
  - 4. Fragmentation

Q.20 According to which of the following constitutional articles in India does the government need to present the estimated receipts and expenditures before the parliament?

- Ans
- 1. Article 212
  - 2. Article 112
  - 3. Article 312
  - 4. Article 412

Q.21 Which of the following is an important step towards offering primary education to all children between the ages of 6 and 14?

- Ans
- 1. Sarva Siksha Abhiyan
  - 2. Rashtriya Madhyamik Shiksha Abhiyan
  - 3. Adult Education Programme
  - 4. Mid-day meal

Q.22 Where in India was the Indian music director and classical flautist Pandit Hariprasad Chaurasia born?

- Ans
- 1. Banaras
  - 2. Bihar
  - 3. Jhansi
  - 4. Prayagraj

Q.23 Which of the following is/are Pteridophyta?

- Ans
- 1. Lichens
  - 2. Mosses
  - 3. Fern
  - 4. Hornworts

Q.24 Pramila Malik was in news to become the first woman Speaker of which state assembly in September 2023?

- Ans
- 1. Odisha
  - 2. Gujarat
  - 3. Karnataka
  - 4. Jharkhand

Q.25 Who said, "A single shelf of a good European library was worth the whole native literature of India and Arabia"?

- Ans
- 1. Thomas Macaulay
  - 2. Max Mueller
  - 3. W Hunter
  - 4. William Jones

Q.26 What is the primary reason for a government to implement a Goods and Services Tax (GST)?

- Ans
- 1. To discourage all kinds of consumption
  - 2. To increase the complexity of the tax system
  - 3. To eliminate all indirect taxes
  - 4. To simplify the tax structure

Q.27 Which of the following is a popular cloud storage service on the internet?

- Ans
- 1. Microsoft Word
  - 2. Google Drive
  - 3. Adobe Photoshop
  - 4. Internet Explorer

Q.28 The Arabian Sea is connected to the Red Sea, through the Strait of Bab-el-Mandeb and the Gulf of Eden, and the Persian Gulf via the \_\_\_\_\_.

- Ans
- 1. Gulf of Riga
  - 2. Gulf of Mexico
  - 3. Gulf of Oman
  - 4. Gulf of Alaska

Q.29 Who called off the Non-Cooperation Movement due to the Chauri Chaura incidence?

- Ans
- 1. Lala Lajpat Rai
  - 2. Mahatma Gandhi
  - 3. Rajendra Prasad
  - 4. Chittaranjan Das

Q.30 What is the meaning of the word 'Taraf' under the Bahmani Sultanate?

- Ans
- 1. Merchant
  - 2. Tax
  - 3. Horse
  - 4. Province

Q.31 Who was honoured with the National Kalidas Samman 2022 award for sitar playing?

- Ans
- 1. Niladri Kumar
  - 2. Purbayan Chatterjee
  - 3. Nishat Khan
  - 4. Budhaditya Mukherjee

Q.32 Which of the following are the features of the Parliamentary form of government?

- 1) The President is the nominal or de jure executive.
- 2) The Prime Minister is the titular executive.
- 3) The President is the head of state.
- 4) The Prime Minister is the head of government.

- Ans
- 1. Only 1, 3 and 4
  - 2. Only 1, 2 and 3
  - 3. Only 1, 2 and 4
  - 4. Only 2, 3 and 4

Q.33 Which freedom is protected by Article 19(d) of the Constitution?

- Ans
- 1. Freedom to reside and settle in any part of India
  - 2. Freedom to move freely throughout the territory of India
  - 3. Freedom to assemble peacefully
  - 4. Freedom of speech and expression

Q.34 Which of the following is a function of the cytoskeleton?

- Ans
- 1. Protein synthesis
  - 2. Cell division
  - 3. ATP production
  - 4. Cell support and shape

Q.35 Which of the following animals is NOT a mammal?

- Ans
- 1. Elephant
  - 2. Dolphin
  - 3. Bat
  - 4. Lizard

Q.36 A cricket ball of mass 160 grams was dropped from a height of 50 metres. What would be its kinetic energy just before touching the ground? [use the value of acceleration due to gravity as  $10 \text{ m/s}^2$ ]

- Ans
- 1. 50 joules
  - 2. 80 joules
  - 3. 8 joules
  - 4. 160 joules

Q.37 What is the purpose of 'customs duty' in international trade?

- Ans
- 1. To encourage unlimited imports
  - 2. To protect domestic industries by taxing imports
  - 3. To standardise products internationally
  - 4. To regulate the export of goods

Q.38 Why is it always emphasised NOT to touch any electric switch board with wet hands?

- Ans
- 1. Water can erode the switchboard.
  - 2. Combination of water and our body is a good conductor of electricity.
  - 3. Wet hands can fade away the colour coat of the switchboard.
  - 4. Wet hands might slip from the switch.

Q.39 Which of the following schemes focuses on reduced imports, increased exports and grassroot campaigns that support local initiatives towards self-reliance?

- Ans
- 1. Samarth Scheme
  - 2. Vocal for Local
  - 3. Mission Karmayogi
  - 4. Skill India Mission

Q.40 Mr Ajit Pawar became the Deputy Chief Minister of which state on 2nd July 2023?

- Ans
- 1. Goa
  - 2. Maharashtra
  - 3. Gujarat
  - 4. Rajasthan

Q.41 It is difficult to carry a heavy shopping bag with thin handles by hand, but slightly easier when the handles are covered with a thick piece of cloth. What is the reason behind that?

- Ans
- 1. Handles become stronger
  - 2. Cloth is colourful
  - 3. Increase in surface area reduces the force exerted
  - 4. Chances of tearing are eliminated

Q.42 Which of the following health campaigns was launched by President Draupadi Murmu through a virtual event on 13 September 2023?

- Ans
- 1. Ayushman Bhav
  - 2. Ayurveda for One Health
  - 3. Yoga for Mental Health
  - 4. Health For All

Q.43 A milliamp is a unit of measurement of electric current, which is equal to how many amps?

- Ans
- 1. 0.0001 AMP
  - 2. 0.00001 AMP
  - 3. 0.001 AMP
  - 4. 0.01 AMP

Q.44 Which group of beneficial bacteria is commonly used in fermented dairy products?

- Ans
- 1. *Campylobacter jejuni*
  - 2. *Lactobacillus acidophilus*
  - 3. *Streptomyces rhizobium*
  - 4. *Staphylococcus aureus*

Q.45 Which disease causes bone pain, stunted growth and soft, weak bones that can lead to skeletal deformities due to not having enough vitamin D?

- Ans
- 1. Rickets
  - 2. Pertussis
  - 3. Dementia
  - 4. Polio

Q.46 Vitamin B12 is also known as:

- Ans
- 1. pantothenic acid
  - 2. cyanocobalamin
  - 3. biotin
  - 4. pyridoxine

Q.47 In which of the following Articles is fundamental duties, like protecting public property and renouncing violence, stated?

- Ans
- 1. Article 11 A
  - 2. Article 36 A
  - 3. Article 51A
  - 4. Article 72 A

Q.48 Prime Minister Narendra Modi officially launched the Central Sector Scheme \_\_\_\_\_, for artisans and crafts persons across India in September 2023.

- Ans
- 1. PM Hastshilpi
  - 2. PM Kaamgaar
  - 3. PM Karigar
  - 4. PM Vishwakarma

Q.49 Limitations Law of 1859 is related to which of the following?

- Ans
- 1. Arms
  - 2. Loan bonds
  - 3. Indigo cultivation
  - 4. Social reform

Q.50 Dribbling skills are NOT used in which of the following sports?

- Ans
- 1. Basketball
  - 2. Hockey
  - 3. Football
  - 4. Chess

Section : General Engineering Electrical

Q.1 In a parallel circuit, if 'n' resistors, each of 'R'  $\Omega$ , are connected in parallel, then the total resistance is equal to \_\_\_\_\_.

- Ans
- 1.  $R/n$
  - 2.  $(R^2)/n$
  - 3.  $R \times n$
  - 4.  $R + n$

Q.2 As per the diffusion principle of street lighting installations, which of the following methods is used to calculate the illumination at any point on the road surface?

- Ans
- 1. Specular reflection method
  - 2. Light flux method
  - 3. Watt per square metre method
  - 4. Inverse-square law method

Q3 The current amplification factor for a transistor in a common base configuration is 0.75. If the emitter current is 4A, find the base current.

- Ans
- 1. 1 A
  - 2. 0 A
  - 3. 3 A
  - 4. 5 A

Q4 Damper winding in synchronous motors is used to \_\_\_\_\_.

- A) Prevent the effect of hunting
- B) Make synchronous motors self-starting
- C) Reduce the speed of synchronous motors
- D) Provide constant synchronous motor torque

- Ans
- 1. B and C
  - 2. A and D
  - 3. A and B
  - 4. C and D

Q5 If the field winding, armature winding are connected in parallel and the combination is connected in parallel with the supply, then this is called a \_\_\_\_\_.

- Ans
- 1. long shunt compound motor
  - 2. series motor
  - 3. shunt motor
  - 4. short shunt compound motor

Q6 In a solar power plant, the output terminals of the solar photovoltaic array can be directly connected to the \_\_\_\_\_.

- Ans
- 1. AC load
  - 2. AC to DC converter
  - 3. AC bus bar
  - 4. DC bus bar

Q7 Which of the following types of installations is NOT a part of NEC (National Electrical Code)?

- Ans
- 1. Sports buildings
  - 2. Agriculture premises
  - 3. Medical establishments
  - 4. Traction

Q8 In regard to estimation and costing of public lighting, which of the following should be adequate to provide visibility that guarantees for the user the maximum safety and sufficient visual comfort?

- Ans
- 1. Limitations of glare
  - 2. Optical guidance
  - 3. Uniformity of luminance
  - 4. Level of luminance

Q9 Select the correct statement regarding coal-fired boilers.

- Ans
- 1. Water-tube boilers are more efficient than fire-tube boilers.
  - 2. Fire-tube boilers are typically used for high-pressure applications.
  - 3. Fire-tube boilers have higher thermal efficiency compared to water-tube boilers.
  - 4. Water-tube boilers are less expensive compared to fire-tube boilers.

Q.10 As per the principles of estimation and costing, if the quantity of materials required for work is not ready, then the minimum order quantity required shall be requested in the \_\_\_\_\_.

- Ans
- 1. purchase enquiry
  - 2. purchase order
  - 3. comparative statement
  - 4. tender enquiry

Q.11 The total capacitance between points P and Q in the figure is:

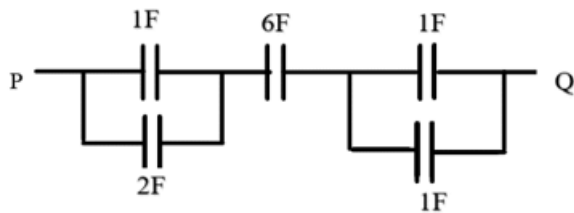

- Ans
- 1. 1 F
  - 2. 11 F
  - 3.  $\frac{43}{6}$  F
  - 4. 10 F

Q.12 Which of the following is NOT a method for solution of medium transmission line?

- Ans
- 1. Nominal-H method
  - 2. End condenser method
  - 3. Nominal-T method
  - 4. Nominal- $\pi$  method

Q.13 The peak value of the output waveform for the sinusoidal input of 30V peak to the circuit is \_\_\_\_\_.



- Ans
- 1. 20V
  - 2. 10V
  - 3. 30V
  - 4. 40V

Q.14 The speed-torque characteristics of which motor whose speed falls when there is increase in load torque is suitable to the application?

- Ans
- 1. DC series motor
  - 2. DC shunt motor
  - 3. DC differential compound motor
  - 4. DC compound motor

Q.15 In any electric circuit, if  $i_1$  and  $i_3$  are incoming currents and  $i_2$  and  $i_4$  are outgoing currents from a node, then according to KCL which is the correct answer?

- Ans
- 1.  $i_1+i_2=i_3+i_4$
  - 2.  $i_4-i_1=i_2+i_3$
  - 3.  $i_1+i_3=i_2+i_4$
  - 4.  $i_1-i_2=i_3-i_4$

Q.16 The built-in potential of a p-n junction \_\_\_\_\_.

- Ans
- 1. depends on both temperature and doping concentration
  - 2. depends on temperature only
  - 3. depends on doping concentration only
  - 4. does not depend on temperature and doping concentration

Q.17 A particular consumer has loads of 200 kW, 400 kW and 300 kW, which are operating continuously. If the maximum demand of the consumer is 600 kW, find the demand factor of the system.

- Ans
- 1. 16.67%
  - 2. 42.5%
  - 3. 66.67%
  - 4. 33.33%

Q.18 A 3-phase voltage of 220 V is applied to a balanced, delta-connected, 3-phase, purely resistive load. Calculate the ratio of the reactive power to the active power.

- Ans
- 1. 1
  - 2. 2
  - 3. 0.5
  - 4. 0

Q.19 What is the diversity factor in a power system?

- Ans
- 1. The ratio of the maximum demand of the power station to the sum of average demands of all consumers connected to it
  - 2. The ratio of the sum of individual maximum demands of all consumers to the maximum demand of the power station
  - 3. The ratio of maximum demand of the power station to the sum of individual maximum demands of all consumers connected to it
  - 4. The ratio of the maximum demand of the power station to the sum of individual minimum demands of all consumers

Q.20 A \_\_\_\_\_ is a failure in a power system of interconnected parts in which the failure of a part can trigger the failure of successive parts.

- Ans
- 1. black out
  - 2. black out and cascade tripping
  - 3. brown out
  - 4. cascade tripping



Q.21 The power dissipated in the  $6\Omega$  resistor is \_\_\_\_\_.

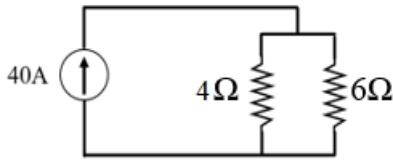

- Ans
- 1. 1000 W
  - 2. 1024 W
  - 3. 3456 W
  - 4. 1536 W

Q.22 Which of the following coefficients provides the relationship between the electric field intensity and the transmitted wave to the incident wave in the medium of origin?

- Ans
- 1. Free space
  - 2. Field reflection
  - 3. Signal attenuation
  - 4. Fresnel reflection

Q.23 Lissajous patterns on a CRO has ten vertical maximum values and eight horizontal maximum values. The frequency of the horizontal input is 1000 Hz. Determine the frequency of the vertical input?

- Ans
- 1. 1344 Hz
  - 2. 1000 Hz
  - 3. 800 Hz
  - 4. 1256 Hz

Q.24 In a metal oxide semiconductor FET, the metal oxide layer acts as a/an \_\_\_\_\_.

- Ans
- 1. gate
  - 2. electric field
  - 3. capacitor
  - 4. dielectric

Q.25 In a drive system, which requires a high starting torque, which of the following electric motors is more suitable?

- Ans
- 1. Synchronous motor
  - 2. Double cage induction motor
  - 3. DC cumulative compound motor
  - 4. DC Series motor

Q.26 The thermal efficiency of a steam plant is defined as \_\_\_\_\_.

- Ans
- 1. the ratio of heat of combustion of coal to the heat equivalent of electrical output
  - 2. the ratio of heat equivalent of mechanical energy transmitted to the turbine shaft to the heat of combustion of coal
  - 3. the ratio of heat equivalent of electrical output to the heat of combustion of coal
  - 4. the ratio of heat of combustion of coal to the heat equivalent of mechanical energy transmitted to the turbine shaft

Q.27 If two identical 2 A, 2  $\Omega$  Norton equivalent circuits are connected in parallel with like polarity connected to like polarity, the combined Norton equivalent circuit is:

- Ans
- 1. 0 A, 1  $\Omega$
  - 2. 4 A, 4  $\Omega$
  - 3. 2 A, 4  $\Omega$
  - 4. 4 A, 1  $\Omega$

Q.28 Which of the following plays a vital role in the determination of sending end and receiving end voltage in ring main AC distribution scheme?

- Ans
- 1. Power factor
  - 2. Hysteresis loss
  - 3. Breakdown voltage of a distribution transformer oil
  - 4. Eddy current loss

Q.29 In the measurement of RMS value of a voltage in CRO, the peak-to-peak voltage is divided by which of the following values?

- Ans
- 1.  $\frac{2}{\sqrt{2}}$
  - 2.  $2\sqrt{2}$
  - 3.  $\sqrt{2}$
  - 4.  $\frac{1}{\sqrt{2}}$

Q.30 An electrical network contains only one loop and no other mesh. How many KVL equations can be formed for the circuit?

- Ans
- 1. 4
  - 2. 1
  - 3. 2
  - 4. 3

Q.31 The consumer associated with the ring main distribution scheme experiences \_\_\_\_\_ as compared to the radial distribution scheme.

- Ans
- 1. less reliable power supply
  - 2. unity power factor always
  - 3. no copper loss
  - 4. less voltage fluctuations

Q.32 Which of the following statements about the hysteresis loop of magnetic materials is correct?

- Ans
- 1. The area of the hysteresis loop of a hard material is greater than that of the soft material.
  - 2. The area of the hysteresis loop of a hard material as well as a soft material is not dependent on temperature.
  - 3. The hysteresis loops of hard and soft materials are of the same area.
  - 4. The area of the hysteresis loop of a hard material is less than that of the soft material.

Q.33 Lambert's Cosine Law describes the relationship between \_\_\_\_\_.

- Ans
- 1. illumination and the angle of light incidence on a surface
  - 2. total lumen on the work plane and lumen emitted by lamp
  - 3. illumination and the distance of light it travels
  - 4. the wavelength of light and its speed in a medium

Q.34 In a fixed bias circuit silicon NPN transistor, common emitter configuration with  $\beta = 50$  is used. Calculate  $V_{CE}$  at quiescent point when  $R_B = 10^6 \Omega$ ,  $R_C = 5 k\Omega$  and  $V_{CC} = 10V$ .

- Ans
- 1. 6.67 V
  - 2. 7.67 V
  - 3. 8.50 V
  - 4. 7.50 V

Q.35 Which of the following statements is true regarding the setting of an earth fault relay?

- Ans
- 1. The setting should always be equal to the rated full-load current of the line.
  - 2. The setting does not depend upon the rated full-load current of the line.
  - 3. The setting should always be greater than the rated full-load current of the line.
  - 4. The setting should always be less than the rated full-load current of the line.

Q.36 Which of the following statements about equivalent circuit with core losses of single-phase motor is/are true?

1. The current drawn by the induction motor when it is not coupled to the driven equipment is called no load current of the motor.
2. The no load current produces the magnetic field in the motor.

- Ans
- 1. Both 1 and 2 are true
  - 2. Only 1 is true
  - 3. Only 2 is true
  - 4. Both 1 and 2 are not true

Q.37 Which of the following statements are true regarding parts of a transformer?

- (i) The thickness of laminations varies from 0.35 mm to 0.5 mm.
- (ii) The material used for breather is blue in colour when it is damp and whitish pink when dry.
- (iii) For a constant input voltage, the output voltage can be varied over a small range by providing few tapings.

- Ans
- 1. (i) and (iii)
  - 2. (i), (ii) and (iii)
  - 3. (i) and (ii)
  - 4. (ii) and (iii)

Q.38 Rotor current frequency = Fractional slip  $\times$  \_\_\_\_\_

- Ans
- 1. EMF
  - 2. Supply frequency
  - 3. Rotor speed
  - 4. No. of poles

Q.39 The average demand of a plant is 55 MW. Find the maximum energy that can be produced if the plant is running at full load according to the operating schedule. The plant use factor is 60%.

- Ans
- 1. 92 MWh
  - 2. 2200 MWh
  - 3. 792 MWh
  - 4. 33 MWh

Q.40 In a single-phase induction motor core loss is neglected. The exciting branch is only consisting of:

- Ans
- 1. exciting reactance
  - 2. no load resistance
  - 3. load resistance
  - 4. load reactance

Q.41 In an induction motor, the relationship between gross mechanical power developed and rotor input is \_\_\_\_\_.

- Ans
- 1. Gross mechanical power developed =  $S \times$  Rotor input
  - 2. Gross mechanical power developed =  $(2-S) \times$  Rotor input
  - 3. Gross mechanical power developed =  $(1-S) \times$  Rotor input
  - 4. Gross mechanical power developed =  $(1/S) \times$  Rotor input

Q.42 In a transistor, the \_\_\_\_\_ region is the widest and the \_\_\_\_\_ region is the thinnest of all.

- Ans
- 1. collector; emitter
  - 2. collector; base
  - 3. emitter; base
  - 4. base; collector

Q.43 Which of the following statements are correct about armature leakage reactance of alternator?

- I. It is dependent on load current.
- II. It does not depend on load current.
- III. It is dependent on the phase angle between armature current and terminal voltage.
- IV. It does not depend on the phase angle between load current and terminal voltage.

- Ans
- 1. Only statements II and IV are correct
  - 2. Only statements I and III are correct
  - 3. Only statements I and IV are correct
  - 4. Only statements II and III are correct

Q.44 Which of the following statements is/are correct regarding superposition theorem?

- (a) It can be used to calculate voltage, current and power.
- (b) It can be used to calculate voltage and current in a circuit containing resistor, capacitor, inductor and diode.
- (c) It can be used to calculate current in a circuit having linear elements resistor, capacitor and inductor.

- Ans
- 1. (c) and (b) only
  - 2. (a) and (b) only
  - 3. (a), (b) and (c)
  - 4. (c) only

Q.45 In electrical circuits, the equivalent resistance of a complicated network of conductors is determined by applying \_\_\_\_\_.

- Ans
- 1. Laplace's law
  - 2. Ampere's circuital law
  - 3. Kirchhoff's law
  - 4. the direct method

Q.46 The value of unknown current in CRO is measured by:

- Ans
- 1. ratio of voltage measured on CRO to resistance of Aquadag
  - 2. ratio of voltage measured on CRO to standard resistance
  - 3. ratio of voltage measured across the unknown resistance to that unknown resistance itself
  - 4. ratio of voltage measured on CRO to resistance of the CRO

Q.47 What is the significance of having hot reserve capacity in a power system?

- Ans
- 1. To ensure power system stability and reliability during emergencies or unexpected events.
  - 2. To provide backup power in case of a complete power outage.
  - 3. To act as a secondary power source during peak demand periods.
  - 4. To meet sudden fluctuations in electricity demand and maintain grid balance

Q.48 Shaded-pole induction motors have which of the following properties?

- Ans
- 1. High starting torque
  - 2. Very high starting torque
  - 3. Low starting torque
  - 4. Medium starting torque

Q.49 In case of electrical installations, if cable conductors are spiralling, then the resistance/unit length will \_\_\_\_\_.

- Ans
- 1. decrease
  - 2. increase
  - 3. remain the same
  - 4. become zero

Q.50 A single phase transmission line is transmitting 1,100 KW power at 11 kV and at unity power factor. If it has a total resistance of 5  $\Omega$ , what is the efficiency of the transmission line?

- Ans
- 1. 80.96%
  - 2. 99.54%
  - 3. 89.65%
  - 4. 100%

Q.51 Back EMF is a significant quantity during operation of a DC motor. Which of the following statements regarding the concept of Back EMF is correct?

- Ans
- 1. The back EMF decreases considerably while loading the motor.
  - 2. Back EMF increases considerably while loading the motor.
  - 3. Back EMF is not necessary for the electromechanical energy conversion in a motor.
  - 4. At no load, the back EMF is zero.

Q.52 The susceptance of the circuit given in the diagram is \_\_\_\_\_.

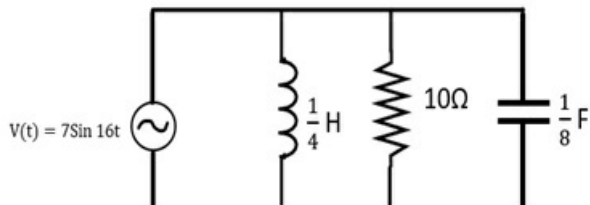

- Ans
- 1.  $(\frac{1}{10} + \frac{j7}{4}) \text{ S}$
  - 2.  $\frac{j4}{7} \text{ S}$
  - 3.  $\frac{j7}{4} \text{ S}$
  - 4.  $(\frac{1}{10} - \frac{j7}{4}) \text{ S}$

Q.53 In an electrostatic instrument, the sensitivity can be increased by \_\_\_\_\_.

- Ans
- 1. increasing the area of the plates
  - 2. increasing the distance between the plates
  - 3. using a phase-shifting capacitor
  - 4. using a magnetic damping mechanism

Q.54 Which of the following statements is correct for the radial distribution network's distributors load change?

- Ans
- 1. The consumer situated at the middle of the distributor will be subjected with serious voltage fluctuations.
  - 2. No consumer in the distribution network will be subjected with any voltage fluctuations.
  - 3. The consumer situated at very close to the distributor will be subjected with serious voltage fluctuations.
  - 4. The consumer situated at the distant end of the distributor will be subjected with serious voltage fluctuations.

Q.55 In a capacitor, if a charge of 1 coulomb accumulates on each plate when a potential difference of 1 volt is applied across the plates, then the capacitance will be \_\_\_\_\_.

- Ans
- 1. 1 nano-farad
  - 2. 1 microfarad
  - 3. 1 farad
  - 4. 1 picofarad

Q.56 In the context of magnetic circuits, if a bar magnet is kept on a paper and iron filings are sprinkled around the magnet, then the iron filings form into closed lines. These lines are called lines of \_\_\_\_\_.

- Ans
- 1. magnetic fringing
  - 2. magnetic angle
  - 3. magnetic motive force
  - 4. magnetic flux

Q.57 If  $\Delta$  is the phase angle between supply voltage and pressure coil flux, which of the following statements is correct about the adjustable resistance used in the energy meter?

- Ans
- 1. It has very low resistance to adjust  $\Delta$  to  $90^\circ$ .
  - 2. It has very high resistance to adjust  $\Delta$  to  $0^\circ$ .
  - 3. It has very high resistance to adjust  $\Delta$  to  $90^\circ$ .
  - 4. It has very low resistance to adjust  $\Delta$  to  $0^\circ$ .

Q.58 In terms of heating effect of electric appliances, what is the percentage of chromium in the stainless steel coils used in space heaters?

- Ans
- 1. 13% to 26%
  - 2. 17% to 23%
  - 3. 10% to 20%
  - 4. 15% to 19%

Q.59 The advantage of using soft starter for an induction motor is for protection against \_\_\_\_\_.

- Ans
- 1. only phase failure
  - 2. phase failure, overcurrent, and undercurrent
  - 3. only undercurrent
  - 4. only overcurrent

Q.60 Calculate the inductance of an air core solenoid of length 400 cm, area of cross-section  $\left(\frac{2}{\pi}\right) m^2$  and having 200 turns.

- Ans
- 1. 10 H
  - 2. 8 mH
  - 3. 0.08 H
  - 4. 8 H

Q.61 The value of Thevenin's voltage across terminal a - b will be \_\_\_\_\_ .

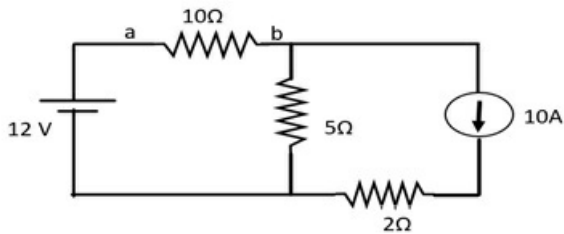

- Ans
- 1. 0 V
  - 2. 50 V
  - 3. 62 V
  - 4. 12 V

Q.62 Choose the correct alternative regarding an electric iron.

- Ans
- 1. Magnesium oxide powder is used for insulation purposes of the heating element.
  - 2. Halogen bulbs are used in an electric iron.
  - 3. The heating element is made up of Chromium.
  - 4. The thermostat used in an electric iron makes use of a single metal strip.

Q.63 A lamp of 80 watt with efficiency of 80% of watt/CP is suspended, The illumination at a point on a working plane directly below the lamp is 25 lumens/m<sup>2</sup>. Determine the height at which the lamp is suspended?

- Ans
- 1. 1.6 meters
  - 2. 3.2 meters
  - 3. 4 meters
  - 4. 2 meters

Q.64 A DC source of EMF E volts and internal resistance R ohms is connected to a variable load and it is adjusted such that the load absorbs maximum power from the source. The current drawn from the source is:

- Ans
- 1.  $\frac{E}{R}$
  - 2.  $\frac{4E}{R}$
  - 3.  $\frac{E}{2R}$
  - 4.  $\frac{2E}{R}$

Q.65 The calculation of sending and receiving end voltage in an AC ring layout considers the voltage drop of:

- Ans
- 1. capacitance alone
  - 2. inductance alone
  - 3. combined effects of resistance, inductance and capacitance
  - 4. resistance alone

Q.66 Which of the following factors is NOT related to the reluctance of the magnetic circuit?

- Ans
- 1. Nature of the magnetic material
  - 2. Length of the magnetic circuit
  - 3. Area of the cross-section of the circuit
  - 4. Magnetomotive force

Q.67 In an electrical circuit, the sum of EMFs of all the sources met on the way plus the voltage drops in the resistances must be zero. This can be explained by \_\_\_\_.

- Ans
- 1. Kirchhoff's current law
  - 2. Laplace's law
  - 3. Kirchhoff's voltage law
  - 4. Ohm's law

Q.68 The magnetic flux through a 150 turns coil increases at the rate of 0.08 wb/s. What is the induced EMF between the ends of the coil?

- Ans
- 1. 20 volts
  - 2. 24 volts
  - 3. 12 volts
  - 4. 120 volts

Q.69 Which of the following types of cooling is employed in small and medium distribution transformers?

- Ans
- 1. Oil filled water cooled
  - 2. Water filled self-cooled
  - 3. Water filled oil cooled
  - 4. Oil filled self-cooled

Q.70 In regard to estimation and costing, the accurate estimate in which the quantity of each item of work is calculated is called \_\_\_\_\_.

- Ans
- 1. rough estimate
  - 2. detailed estimate
  - 3. supplementary estimate
  - 4. approximate estimate

Q.71 The connections of three-phase energy metre for measuring three-phase power, three wire energy is similar to the connections of \_\_\_\_\_.

- Ans
- 1. two wattmeter for power measurement
  - 2. three wattmeter for voltage measurement
  - 3. two wattmeter for voltage measurement
  - 4. three wattmeter for power measurement

Q.72 Power measured using 2 wattmeter method from a three-phase balanced/unbalanced load where line voltage =  $V_L$ , Line current =  $I_L$ , Phase voltage =  $V_P$  and Phase current =  $I_P$  is given by:

- Ans
- 1.  $\sqrt{3}V_P I_P \sin\phi$
  - 2.  $3V_L I_L \cos\phi$
  - 3.  $\sqrt{3} V_P I_P \cos\phi$
  - 4.  $\sqrt{3} V_L I_L \cos\phi$



Q.73 In case of a p-n junction diode, the change in temperature due to heating \_\_\_\_\_.

- Ans
- 1. affects the entire V-I characteristics of the p-n junction diode
  - 2. causes no change in the resistance of the p-n junction diode
  - 3. affects only the reverse resistance of the p-n junction diode
  - 4. affects only the forward resistance of the p-n junction diode

Q.74 Which of the following is NOT correct with reference to full load testing of a single-phase transformer?

- Ans
- 1. This test is used to determine temperature rise and efficiency of the transformer.
  - 2. This test is used to determine voltage regulation of the transformer.
  - 3. In Sumpner's test, two identical transformers are taken, in which primary windings are connected in parallel whereas secondary windings are connected in series.
  - 4. In Sumpner's test, two identical transformers are taken, in which primary windings are connected in parallel whereas secondary windings are connected in series but in phase opposition.

Q.75 In electric power, if a body makes N rpm and the torque acting is T newton-meter, then work done per minute will be \_\_\_\_\_.

- Ans
- 1.  $m \times g$  joules
  - 2. mgh joules
  - 3.  $(2\pi NT)/60$  joules
  - 4.  $2\pi NT$  joules

Q.76 Two identical coils A and B have 400 turns placed such that 60% of flux produced by one coil links with the other. If a current of 10A flowing in coil A produces a flux of 20 mWb in it, find the mutual inductance between coil A and B.

- Ans
- 1. 480 H
  - 2. 100 H
  - 3. 0.48 H
  - 4. 10 H

Q.77 An induction motor can be treated as a transformer with \_\_\_\_\_.

- Ans
- 1. open circuited secondary winding
  - 2. short circuited secondary winding
  - 3. short circuited primary winding
  - 4. open circuited primary winding

Q.78 What is the drawback of a Permanent Magnet Moving Coil (PMMC) instrument?

- Ans
- 1. Low torque / weight ratio
  - 2. High power consumption
  - 3. Absence of effective and efficient current damping
  - 4. Relatively high-cost as compared to moving iron instruments

Q.79 A 415 V, 3-phase voltage is applied to a balanced star connected purely resistive load of  $10 \Omega$ . What is the ratio of reactive power to active power?

- Ans
- 1. 100
  - 2. 1
  - 3. Infinity
  - 4. 0

Q.80 A 400V, 3-phase, star-connected synchronous motor has armature current of 200A at effective resistance of 0.04 OHMS. The short-circuit load loss at half-full load is \_\_\_\_\_.

- Ans
- 1. 2000W
  - 2. 2100 W
  - 3. 1200 W
  - 4. 1000W

Q.81 Stability factors are defined as the rate of change of \_\_\_\_\_ with respect to the \_\_\_\_\_, keeping both the base current and the current gain  $\beta$  constant.

- Ans
- 1. collector base leakage current; collector current
  - 2. collector current; collector base leakage current
  - 3. emitter current; collector base leakage current
  - 4. collector base leakage current; emitter current

Q.82 The polar form of a vector is  $10\angle 30$ . What is the rectangular form of this vector?

- Ans
- 1.  $\sqrt{3} + j5$
  - 2.  $10\sqrt{3} + j2$
  - 3.  $5\sqrt{3} + j5$
  - 4.  $15\sqrt{3} + j3$

Q.83 What are bushings in transformers used for?

- Ans
- 1. They are used to filter contaminants from the transformer oil.
  - 2. They are used to insulate the transformer leads as they come out through the tank.
  - 3. They are used to cool the transformer oil.
  - 4. They are used to connect the transformer to the power grid.

Q.84 Which of the following are the significance of good welds?

- I) Good welds provide strong and reliable bonds between metal components.
- II) High-quality welds require the need for rework, repairs, etc.
- III) They assist fatigue, corrosion and wear contributing to reduce the longevity of the structures.
- IV) Good welds not only provide functional benefits but also contribute to the aesthetics of finished products.

- Ans
- 1. II and IV
  - 2. II and III
  - 3. I and IV
  - 4. I and III

Q.85 How is the resistance of a wire related to the length of the wire?

- Ans
- 1. Not related
  - 2. Inversely proportional
  - 3. Proportional to square of length
  - 4. Directly proportional

Q.86 The average power delivered to an AC series circuit is given by:

- Ans
- 1.  $I V_{rms} \times I_{rms} \cos \theta$
  - 2.  $I(\max) \times V(\max) \times \sin(\theta)$
  - 3. Zero
  - 4.  $I(\max) \times V(\max)$

Q.87 The energy consumed by a  $5\Omega$  resistor carrying a 20A current in 10 minutes will be \_\_\_\_\_.

- Ans
- 1. 120 J
  - 2. 120 KJ
  - 3. 2000 J
  - 4. 1200 KJ

Q.88 In an electrostatic instrument, the controlling torque can be adjusted by:

- I. Changing the spring constant
- II. Changing the length of the pointer needle
- III. Changing the distance between the plates
- IV. Changing the position of the instrument

- Ans
- 1. Only III and IV
  - 2. Only I and II
  - 3. Only I and IV
  - 4. Only I and III

Q.89 To determine the voltage regulation of synchronous generators, the direct load test is suitable only for alternators with power rating:

- Ans
- 1. more than 5 kVA
  - 2. less than 2 kVA
  - 3. less than 5 kVA
  - 4. less than 3 kVA

Q.90 In a semiconductor diode, the ratio of change in the forward biased voltage across the diode to change in the current in the diode is called \_\_\_\_\_.

- Ans
- 1. AC reverse resistance
  - 2. AC forward resistance
  - 3. DC reverse resistance
  - 4. DC forward resistance

Q.91 In CRO, the measurement of time period is obtained by the product of the number of divisions occupied by one cycle and \_\_\_\_\_.

- Ans
- 1. Time/Division
  - 2. Division/time
  - 3. Division/cycle
  - 4. Time/cycle

Q.92 In stator resistance starter, if applied voltage across motor terminals is reduced by 50%, then torque is reduced to \_\_\_\_\_ of the full voltage value.

- Ans
- 1. 50%
  - 2. 12.5%
  - 3. 75%
  - 4. 25%

Q.93 The starting torque of a slip ring induction motor is maximum when rotor resistance/phase is \_\_\_\_\_ rotor reactance/phase.

- Ans
- 1. less than
  - 2. more than
  - 3. equal to
  - 4. not equal to

Q.94 What is the purpose of a maximum power point tracker (MPPT) in a PV system?

- Ans
- 1. To maximise the electrical power output of the PV system
  - 2. To convert DC current to AC current
  - 3. To increase the open circuit voltage (Voc) of the PV cells
  - 4. To reduce the power losses within the PV cells

Q.95 Which of the following is a key indicator of good weld quality?

- Ans
- 1. A good weld should be non-uniform throughout its length
  - 2. No crater cracking on the weld
  - 3. The weld metal burns through the base material
  - 4. The depth of weld penetration is minimal

Q.96 In the estimation and costing, utmost importance is given for the payment of suppliers in an agreed time in order to maintain \_\_\_\_\_.

- Ans
- 1. the contract
  - 2. the guarantee
  - 3. flexibility
  - 4. deposit security

Q.97 Which of the following materials is most commonly used for the filaments in incandescent lamps?

- Ans
- 1. Iron
  - 2. Gold
  - 3. Tungsten
  - 4. Aluminium

Q.98 Which of the following conditions is favourable for the application of radial distribution network?

- Ans
- 1. Power is generated at high voltage and substation is located very far away from the load centre
  - 2. Power is generated at low voltage and substation is located very far away from load centre
  - 3. Power is generated at high voltage and substation is located at the load centre
  - 4. Power is generated at low voltage and substation is located at the load centre

Q.99 The ring main distribution system is preferred over radial distribution system because \_\_\_\_\_.

- Ans
- 1. there is no requirement of distribution transformer
  - 2. it always possesses unity power factor
  - 3. it has fewer voltage fluctuation at consumers side
  - 4. there is no Ohmic loss

Q.100 What do you understand by fundamental period of a signal?

- Ans
- 1. Time taken to complete every cycle of a periodic signal
  - 2. Time taken to complete every cycle of an aperiodic signal
  - 3. Time taken to complete last cycle of a periodic signal
  - 4. Time taken to complete first cycle of a periodic signal



## Junior Engineer Civil Mechanical and Electrical Examination 2024 Paper I

Exam Date	05/06/2024
Exam Time	9:00 AM - 11:00 AM
Subject	Junior Engineer 2024 Civil Paper I

### Section : General Intelligence and Reasoning

Q1 126 is related to 135 following a certain logic. Following the same logic, 214 is related to 223. To which of the following is 425 related following the same logic?

(NOTE: Operations should be performed on the whole numbers, without breaking down the numbers into its constituent digits. E.g. 13 – Operations on 13 such as adding /subtracting /multiplying etc. to 13 can be performed. Breaking down 13 into 1 and 3 and then performing mathematical operations on 1 and 3 is not allowed.)

- Ans
- 1. 424
  - 2. 434
  - 3. 444
  - 4. 454

Q2 In a certain code language, 'VALUES' is coded as '13579\$' and 'VALUED' is coded as '573#91'. What is the code for 'D' in the given code language?

- Ans
- 1. \$
  - 2. 1
  - 3. #
  - 4. 9

Q3 Select the correct mirror image of the given figure when the mirror is placed at MN as shown below.

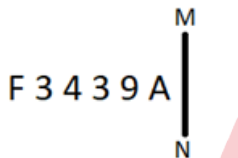

- Ans
- 1. Ɔ ʌ ɹ ʇ Ɔ Ɔ
  - 2. A Ɔ ʇ Ɔ Ɔ F
  - 3. F Ɔ ʇ Ɔ Ɔ A
  - 4. 9 A Ɔ ʇ Ɔ F

Q4 The position(s) of how many letters will remain unchanged if each of the letters in the word REWINDS is arranged in the English alphabetical order?

- Ans
- 1. Zero
  - 2. Three
  - 3. One
  - 4. Two

Q5 What should come in place of the question mark (?) in the given series based on the English alphabetical order?  
BFA, EIE, HLI, KOM, NRQ, ?

- Ans
- 1. QUV
  - 2. QVW
  - 3. QVV
  - 4. QUU

Q.6 Select the option figure that will replace the question mark (?) in the figure given below to complete the pattern.



Ans

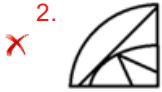

Q.7 Read the given statements and conclusions carefully. Assuming that the information given in the statements is true, even if it appears to be at variance with commonly known facts, decide which of the given conclusions logically follow(s) from the statements.

Statements: Some bikes are trucks. All trucks are planes.

Conclusion 1: Some bikes are planes.

Conclusion 2: No truck is a bike.

Ans

1. None of the conclusions follow

2. Only conclusion (1) follows

3. Only conclusion (2) follows

4. Both conclusion (1) and conclusion (2) follow

Q.8 What will come in place of the question mark (?) in the following equation if '+' and 'x' are interchanged?

$$39 + 27 \div 108 \times 9 - 16 = ?$$

Ans

1. 347

2. 342

3. 339

4. 351

Q.9 QTRU is related to SVTW in a certain way based on the English alphabetical order. In the same way, TWUX is related to VYWZ. To which of the following is LOMP related, following the same logic?

Ans

1. QNOR

2. NQRO

3. NQOR

4. QNRO

Q.10 Select the figure from the options that can replace the question mark (?) and complete the given pattern.

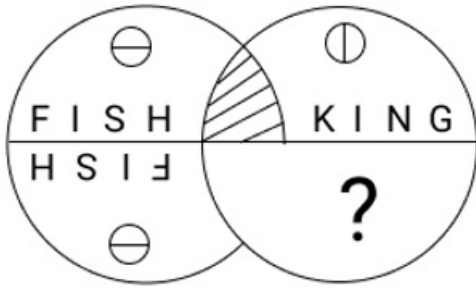

Ans

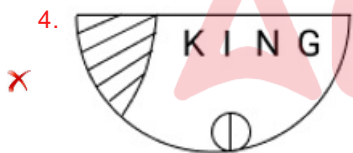
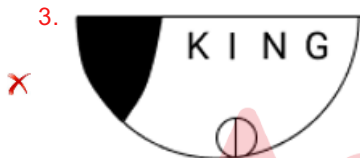
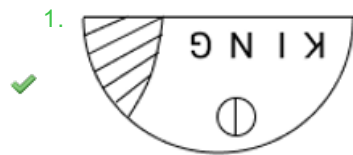

Q.11 What will come in place of the question mark (?) in the following equation if '+' and '-' are interchanged and 'x' and '÷' are interchanged?

$$13 \div 2 - 15 + 120 \times 4 = ?$$

Ans

✓ 1. 11

✗ 2. 15

✗ 3. 13

✗ 4. 7



Q.12 In a certain code language, 'don't worry you' is coded as 'ab kl gy' and 'you have no' is coded as 'gy ad mn'. How is 'you' coded in the given language?

- Ans
- 1. ab
  - 2. gy
  - 3. mn
  - 4. kl

Q.13 What should come in place of the question mark (?) in the given series?  
16, 25, 34, 43, 52, ?

- Ans
- 1. 62
  - 2. 69
  - 3. 61
  - 4. 60

Q.14 Select the correct option that indicates the arrangement of the following words in a logical and meaningful order.

1. Root
2. Branch
3. Twig
4. Trunk
5. Leaf

- Ans
- 1. 1, 3, 4, 5, 2
  - 2. 1, 5, 3, 2, 4
  - 3. 1, 2, 5, 4, 3
  - 4. 1, 4, 2, 3, 5

Q.15 What should come in place of the question mark (?) in the given series based on the English alphabetical order?  
WLI, BJJ, GHK, LFL, QDM, ?

- Ans
- 1. UCN
  - 2. VBN
  - 3. QBN
  - 4. RBM

Q.16 How many triangles are there in the given figure?

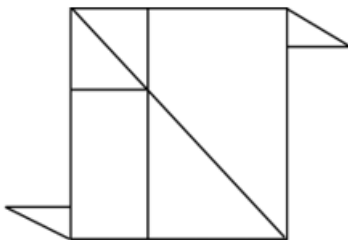

- Ans
- 1. 10
  - 2. 7
  - 3. 9
  - 4. 8

Q.17 L, A, N, T, E, R, and S are sitting around a circular table, facing the centre (not necessarily in the same order). L sits third to the right of E. E sits second to the right of T. S sits third to the left of T. N sits third to the left of A.  
Who is sitting to the immediate left of A?

- Ans
- 1. T
  - 2. E
  - 3. N
  - 4. L

Q.18 In a certain code language, 'RICE' is coded as '5379' and 'COLD' is coded as '8432'.  
What is the code for 'C' in the given code language?

- Ans
- 1. 4
  - 2. 5
  - 3. 3
  - 4. 2

Q.19 MILK is related to OLPL in a certain way based on the English alphabetical order. In the same way, TILE is related to VLPF. To which of the following is STAR related, following the same logic?

- Ans
- 1. UWES
  - 2. VWFS
  - 3. UWFS
  - 4. VWES

Q.20 OTNQ is related to SXRU in a certain way based on the English alphabetical order. In the same way, JOIL is related to NSMP. To which of the following is MRLO related, following the same logic?

- Ans
- 1. VQPS
  - 2. QVSP
  - 3. QVPS
  - 4. VQSP

Q.21 ZX 9 is related to ML 3 in a certain way. In the same way, VT 12 is related to KJ 4. To which of the following is RP 15 related, following the same logic?

- Ans
- 1. HR 8
  - 2. JH 6
  - 3. IH 5
  - 4. HE 7

Q.22 What should come in place of the question mark (?) in the given series based on the English alphabetical order?  
YXB, FEI, MLP, TSW, AZD, ?

- Ans
- 1. HGK
  - 2. HKL
  - 3. JKL
  - 4. GKM

Q.23 Select the set in which the numbers are related in the same way as are the numbers of the following sets.

(NOTE : Operations should be performed on the whole numbers, without breaking down the numbers into its constituent digits. E.g. 13 – Operations on 13 such as adding /subtracting /multiplying etc. to 13 can be performed. Breaking down 13 into 1 and 3 and then performing mathematical operations on 1 and 3 is not allowed)  
(5, 20)  
(10, 90)

- Ans
- 1. (6, 24)
  - 2. (7, 49)
  - 3. (9, 72)
  - 4. (8, 40)

Q.24 Read the given statements and conclusions carefully. You have to take the given statements to be true even if they seem to be at variance from commonly known facts. You have to decide which conclusion/s logically follow/s from the given statements.

Statements: All lions are tigers. All lions are pigeons. All tigers are apes.

Conclusions:

(I) All pigeons are apes.

(II) At least some tigers are pigeons.

- Ans
- 1. Both conclusions (I) and (II) follow.
  - 2. Neither conclusion (I) nor (II) follows.
  - 3. Only conclusion (II) follows.
  - 4. Only conclusion (I) follows.

Q.25 Six babies Ria, Sia, Tia, Urja, Vani and Winnie are born one after the other but not necessarily in the same order. All of them were born in different cities. Only two babies were born before the one who was born in Raipur. Only one baby was born between Sia, who was born in Delhi and the baby born in Raipur. Tia was born before Urja and just after the baby born in Haridwar. Tia was not born in Raipur. Ria was born in Bhopal and just before Vani. Tia was born immediately before the baby born in Ballia. Winnie was not born in Pune. Which baby was born in Raipur?

- Ans
- 1. Urja
  - 2. Ria
  - 3. Vani
  - 4. Tia

Q.26 A, B, C, D, P, Q, and R are sitting around a circular table, facing the centre (not necessarily in the same order) .R sits fourth to the left of B. D sits second to the right of B.A is an immediate neighbour of B and D. Q sits third to the left of A.P is an immediate neighbour of Q and R.

Who is sitting third to the right of R?

- Ans
- 1. A
  - 2. D
  - 3. C
  - 4. Q

Q.27 In a certain code language,  
 'A + B' means 'A is the mother of B',  
 'A - B' means 'A is the brother of B',  
 'A × B' means 'A is the sister of B', and  
 'A ÷ B' means 'A is the husband of B'.  
 How is K related to L if 'L + A - B ÷ K × G + F'?

- Ans
- 1. Daughter
  - 2. Son's daughter
  - 3. Son's wife
  - 4. Daughter's daughter

Q.28 Select the option in which the given figure is embedded (rotation is NOT allowed).



- Ans
- 1.
  - 2.
  - 3.
  - 4.

Q.29 What should come in place of the question mark (?) in the given series based on the English alphabetical order?

MQU, JRT, GSS, DTR, ?

- Ans
- 1. AUQ
  - 2. AUP
  - 3. BUQ
  - 4. ATQ

Q.30 'JK 2' is related to 'MN 12' in a certain way based on the English alphabetical and numerical order. In the same way, 'IJ 25' is related to 'LM 150'. To which of the following is 'RS 24' related following the same logic?

- Ans
- 1. UV 169
  - 2. TV 194
  - 3. TV 169
  - 4. UV 144

Q.31 Ajay starts from his home and drives 5 km towards the south. He then takes a left turn, drives 6 km, turns right, and drives 4 km. He then takes a left turn and drives 5 km and reached his office. In which direction is the office with respect to his home? (All turns are 90° turns only, unless specified.)

- Ans
- 1. North-east
  - 2. South-east
  - 3. North-west
  - 4. South-west

Q.32 Which numbers should come in place of the two question marks '?' in the same sequence to make the series logically complete?  
2, 3, 5, 8, 13, ?, 34, ?

- Ans
- 1. 19, 53
  - 2. 22, 56
  - 3. 20, 54
  - 4. 21, 55

Q.33 SX 27 is related to ZE 9 in a certain way. In the same way, KP 72 is related to RW 24. To which of the following is FK 3 related, following the same logic?

- Ans
- 1. MR 1
  - 2. NS 1
  - 3. MP 9
  - 4. NT 9

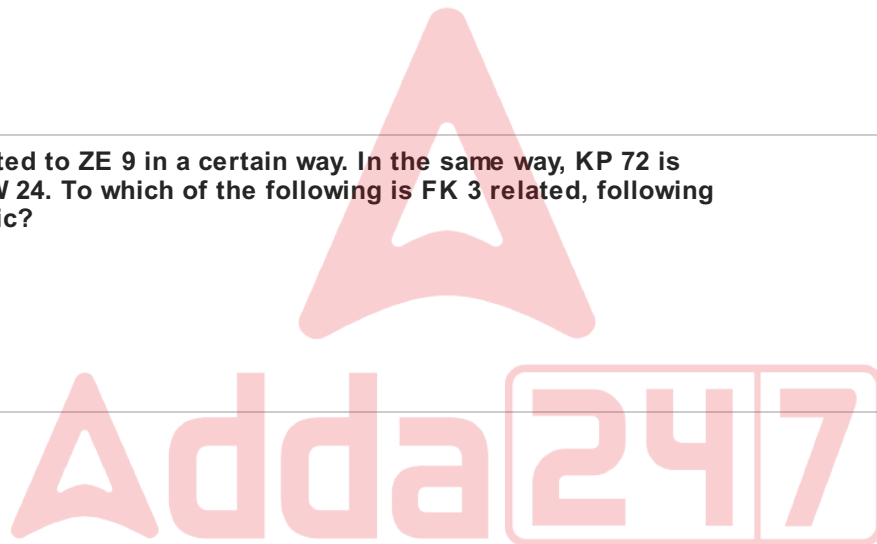

Q.34 Select the option in which the given figure is embedded (rotation is NOT allowed).



Ans

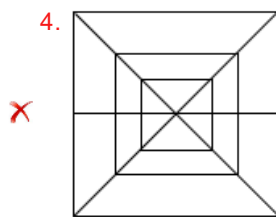
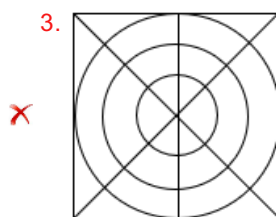
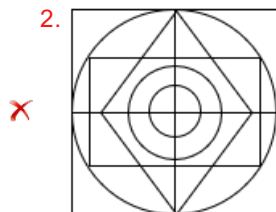
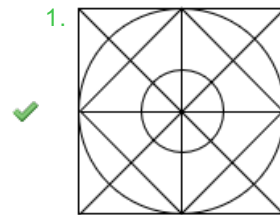

Q.35 In a certain code language,  
 'K + L' means 'K is the mother of L',  
 'K - L' means 'K is the sister of L',  
 'K × L' means 'K is the husband of L',  
 'K ÷ L' means 'K is the father of L'.  
 How is R related to U if 'P × Q - R ÷ S + T - U'?

Ans

- 1. son
- 2. Mother's father
- 3. father
- 4. Father's father

Q.36 14 is related to 42 following a certain logic. Following the same logic, 25 is related to 75. To which of the following is 44 related, following the same logic?

(NOTE: Operations should be performed on the whole numbers, without breaking down the numbers into its constituent digits. E.g. 13 - Operations on 13 such as adding/subtracting/multiplying etc. to 13 can be performed. Breaking down 13 into 1 and 3 and then performing mathematical operations on 1 and 3 is not allowed.)

Ans

- 1. 131
- 2. 134
- 3. 132
- 4. 133

Q.37 Select the set in which the numbers are related in the same way as are the numbers of the following sets.  
(NOTE: Operations should be performed on the whole numbers, without breaking down the numbers into its constituent digits. E.g. 13 – Operations on 13 such as adding/subtracting/multiplying etc. to 13 can be performed. Breaking down 13 into 1 and 3 and then performing mathematical operations on 1 and 3 is not allowed.)  
(48, 23, 47)  
(22, 27, 38)

- Ans
- 1. (18, 22, 28)
  - 2. (14, 30, 41)
  - 3. (26, 14, 32)
  - 4. (16, 31, 39)

Q.38 In a certain code language, 'PFE' is coded as '54' and 'NUJ' is coded as '36'. What is the code for 'AZL' in the given language?

- Ans
- 1. 51
  - 2. 47
  - 3. 53
  - 4. 42

Q.39 This question consists of a pair of words that have a certain relationship to each other. Select the pair that has the same relationship.

(The words must be considered as meaningful English words and must not be related to each other based on the number of letters/number of consonants/vowels in the word.)

Compassion : Sympathy

- Ans
- 1. Feeble : Strong
  - 2. Consolidate : Weaken
  - 3. Gorgeous : Dull
  - 4. Lucid : Eloquent

Q.40 The position(s) of how many letters will remain unchanged if each of the letters in the word SHORTEN is arranged in the English alphabetical order?

- Ans
- 1. Two
  - 2. Three
  - 3. One
  - 4. Zero

Q.41 If 'A' stands for '+', 'B' stands for 'x', 'C' stands for '+' and 'D' stands for '-', what will come in place of the question mark '?' in the following equation?

24 B 12 D 39 A 13 C 15 = ?

- Ans
- 1. 310
  - 2. 300
  - 3. 299
  - 4. 295

Q.42 What should come in place of the question mark (?) in the given series based on the English alphabetical order?

TOJ, NID, HCX, BWR, ?

- Ans
- 1. VQL
  - 2. VLQ
  - 3. QLV
  - 4. QVL

Q.43 Select the option that indicates the arrangement of the following words in meaningful and logical order.

1. Doctor
2. Cure
3. Accident
4. Injury
5. Medicine

- Ans
- 1. 1, 3, 2, 4, 5
  - 2. 2, 1, 5, 4, 3
  - 3. 3, 4, 1, 5, 2
  - 4. 4, 1, 3, 2, 5

Q.44 What should come in place of the question mark (?) in the given series?  
82, 83, 80, 81, 78, ?

- Ans
- 1. 79
  - 2. 81
  - 3. 76
  - 4. 77





Q.45 Select the correct mirror image of the given figure when the mirror is placed at MN as shown below.

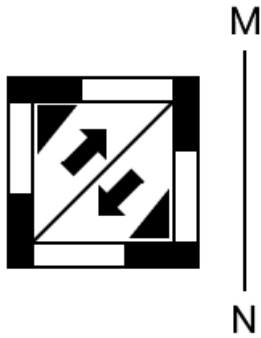

Ans

1.
2.
3.
4.

Q.46 Pillar E is to the east of Pillar D. Pillar A is to the west of Pillar D. Pillar B is to the north of Pillar A. Pillar C is to the south of Pillar A. Pillar E is to the south of F. Pillar G is to the South of E. What is the position of Pillar F with respect to Pillar C?

- Ans
1. South - West
  2. North
  3. North - East
  4. South

Q.47 What will come in place of the question mark (?) in the following equation if '+' and '-' are interchanged and 'x' and '÷' are interchanged?

$$33 \times 3 \div 2 + 10 - 5 = ?$$

- Ans
- 1. 17
  - 2. 15
  - 3. 16
  - 4. 14

Q.48 What should come in place of the question mark (?) in the given series based on the English alphabetical order?  
HXK, GWL, FVM, EUN, ?

- Ans
- 1. DTO
  - 2. ORP
  - 3. FTO
  - 4. DRO

Q.49 13 is related to 190 following a certain logic. Following the same logic, 10 is related to 145. To which of the following is 20 related following the same logic?  
(NOTE: Operations should be performed on the whole numbers, without breaking down the numbers into their constituent digits. E.g. 13 – Operations on 13 such as adding / subtracting / multiplying to 13 can be performed. Breaking down 13 into 1 and 3 and then performing mathematical operations on 1 and 3 is not allowed.)

- Ans
- 1. 295
  - 2. 298
  - 3. 290
  - 4. 294

Q.50 11 is related to 66 following a certain logic. Following the same logic, 22 is related to 132. To which of the following is 41 related, following the same logic?

(NOTE: Operations should be performed on the whole numbers, without breaking down the numbers into its constituent digits. E.g. 13 – Operations on 13 such as adding/subtracting/multiplying etc. to 13 can be performed. Breaking down 13 into 1 and 3 and then performing mathematical operations on 1 and 3 is not allowed.)

- Ans
- 1. 250
  - 2. 246
  - 3. 242
  - 4. 248

Section : General Awareness

Q.1 Which of the following organisations was founded by Jyotiba Phule to propagate caste equality?

- Ans
- 1. Satyashodhak Samaj
  - 2. Prarthana Samaj
  - 3. Vedanta Samaj
  - 4. Brahma Samaj

Q.2 According to Census of India 2011, which state recorded the second lowest literacy rate in India?

- Ans
- 1. Assam
  - 2. Arunachal Pradesh
  - 3. Manipur
  - 4. Tripura

**Q.3 On 1st September 2023, who was appointed as Chairman and CEO of Railway Board?**

- Ans
- 1. Naresh Lalwani
  - 2. Amar Dwivedi
  - 3. Manoj Sharma
  - 4. Jaya Verma Sinha

**Q.4 What is the term for the process of water loss from plant leaves through tiny openings called stomata?**

- Ans
- 1. Respiration
  - 2. Transpiration
  - 3. Germination
  - 4. Photosynthesis

**Q.5 In which of the following cities of India was the 4th Mayor's Trophy International Grandmaster Chess Tournament - 2023 organised?**

- Ans
- 1. Panaji
  - 2. Patna
  - 3. Indore
  - 4. Chennai

**Q.6 According to the Preamble, what does the promotion of fraternity assure?**

- Ans
- 1. Allows all to profess, preach and practice any religion
  - 2. Thought, expression, belief, faith and worship
  - 3. Economic opportunities
  - 4. Unity and integrity of the nation

**Q.7 Which of the following pairs is correctly matched?**

- Ans
- 1. Kabaddi – 9 players in a team
  - 2. Cricket – 11 players in a team
  - 3. Football – 13 players in a team
  - 4. Hockey – 10 players in a team

**Q.8 In 2001, Eric A Cornell along with which two scientists received the Nobel Prize in Physics for achieving 'Bose-Einstein Condensation'?**

- Ans
- 1. Sergei Winogradsky and Arieh Warshel
  - 2. Wolfgang Ketterle and Carl E Wieman
  - 3. William Crookes and Gemma Stephenson
  - 4. Frank Wilczek and Harold Urey

**Q.9 \_\_\_\_\_ assumed the charge as Registrar General & Census Commissioner of India with effect from November 1, 2022.**

- Ans
- 1. Amit Shah
  - 2. Mritunjay Kumar Narayan
  - 3. Dr. C Chandramouli
  - 4. Piyush Goyal

**Q.10 What is the name of the scheme under which the Government of India has planned to provide skill training for 2 crore women as announced in August 2023?**

- Ans
- 1. Ladli Beti
  - 2. Sudarshna Scheme
  - 3. Lakhpati Didi
  - 4. Meri Behan

Q.11 What percentage of women were nominated to the panel of Vice-Chairpersons in the Upper House on 20 July 2023?

- Ans
- 1. 15%
  - 2. 25%
  - 3. 50%
  - 4. 75%

Q.12 Which of the following animals are endemic to Australia?

- Ans
- 1. Kangaroo
  - 2. Dog
  - 3. Giant Panda
  - 4. Elephant

Q.13 What does the term 'e-commerce' refer to?

- Ans
- 1. Trading of commodities
  - 2. Buying and selling of goods and services over the internet
  - 3. Exchange of goods for services
  - 4. Government-regulated commerce

Q.14 Who was the music director of the film Bees Saal Baad, which was released in 1962?

- Ans
- 1. Shyamal Mitra
  - 2. Bimal Roy
  - 3. V Balsara
  - 4. Hemant Kumar

Q.15 Which of the following locations is known for lignite coal production?

- Ans
- 1. Talcher
  - 2. Bokaro
  - 3. Korba
  - 4. Neyveli

Q.16 Which of the following statements is/are correct?

- I. M0 is called broad money
- II. M1 is called narrow money
- III.  $M0 = \text{Currency in Circulation} + \text{Bankers' Deposits with RBI} + \text{'Other' Deposits with RBI}$

- Ans
- 1. Only II and III
  - 2. Only I and III
  - 3. Only I
  - 4. Only III

Q.17 In which state is the 'Barauni' coal based power station located?

- Ans
- 1. Assam
  - 2. Bihar
  - 3. Meghalaya
  - 4. Goa

Q.18 In which of the following forms of government does the executive enjoy the right to dissolve the Legislature?

- Ans
- 1. Presidential form of government
  - 2. Totalitarian government
  - 3. Parliamentary form of government
  - 4. Oligarchy

Q.19 Which chemical reaction occurs when you mix vinegar (acetic acid) and baking soda (sodium bicarbonate)?

- Ans
- 1. Oxidation
  - 2. Precipitation
  - 3. Neutralisation
  - 4. Combustion

Q.20 Since the attraction between molecules of gas is very low, what benefit do we get from this property of gas?

- Ans
- 1. Compressed and stored in smaller cylinders
  - 2. Burns easily
  - 3. Does not move from one place to another
  - 4. Does not change their shape easily

Q.21 The \_\_\_\_\_ is famous for 'Karewa' formations.

- Ans
- 1. Thar Desert
  - 2. Rann of Kutch
  - 3. Coromandel Coast
  - 4. Kashmir Himalayas

Q.22 What is the chemical formula for ammonia?

- Ans
- 1. NaCl
  - 2. NH<sub>3</sub>
  - 3. H<sub>2</sub>O
  - 4. CO<sub>2</sub>

Q.23 Manish Desai was in the news for taking charge of which post in the Press Information Bureau in September 2023?

- Ans
- 1. Principal Director General
  - 2. Deputy Director
  - 3. Additional Director General
  - 4. Joint Director

Q.24 Who among the following was an Anglo-Indian teacher of the Hindu college of Calcutta to initiate the Young Bengal Movement?

- Ans
- 1. Henry Colbert
  - 2. Henry Vivian Derozio
  - 3. David Hare
  - 4. Charles wilkins

Q.25 Which of the following is a green alga found in vast masses of a variety of marine and fresh waters?

- Ans
- 1. Porphyra
  - 2. Gelidium
  - 3. Sargassum
  - 4. Cladophora

Q.26 The Assam Darrang and Lakhimpur Districts (Assimilation of Laws on State Subjects) (Repealing) Act, 2022, received the Governor's assent in \_\_\_\_\_.

- Ans
- 1. April 2023
  - 2. January 2023
  - 3. March 2023
  - 4. February 2023

Q.27 When did the new judicial system of setting up two courts (Criminal and civil) in each district start?

- Ans
- 1. 1756 C.E.
  - 2. 1773 C.E.
  - 3. 1774 C.E.
  - 4. 1772 C.E.

Q.28 Which keyboard shortcut can be used to Print the Microsoft Word document?

- Ans
- 1. Ctrl + P
  - 2. Ctrl + S
  - 3. Ctrl + V
  - 4. Ctrl + Z

Q.29 One characteristic of viruses is that they do not show any signs of life unless they enter a living host and start multiplying using the host's cell. What is the main reason behind this?

- Ans
- 1. They camouflage themselves as non-living to find a host.
  - 2. They lack cell membrane and other organelles.
  - 3. They lack DNA.
  - 4. They need heat of the hosts body to multiply.

Q.30 What is the reason behind the Indian peninsular region not showing drastic change during winters and having a moderate temperature?

- Ans
- 1. moderating Influence of dense human population
  - 2. moderating Influence of heavy monsoon
  - 3. moderating Influence of the sea
  - 4. moderating Influence of plateaus

Q.31 Sahil Sarabhai is standing in the middle. On one side, his wife Monisha is pulling him with a force of 100 N eastward, whereas his mother, Maya is pulling him with a force of 150 N westward. What will be the net force on Sahil and towards whom will he move in the end if at all?

- Ans
- 1. 50N, Monisha
  - 2. 250N, will not move
  - 3. 50N, Maya
  - 4. -50N, Maya

Q.32 Most seawater has about how much salt in every 1,000 g (about a litre) of water?

- Ans
- 1. 100 g
  - 2. 200 g
  - 3. 15 g
  - 4. 35 g

Q.33 Hemant Chauhan, who received the Padma Shri in 2023, is associated with:

- Ans
- 1. Bengali music
  - 2. Gujarati music
  - 3. Kannada music
  - 4. Telugu music

Q.34 Which of the following is the third largest ocean in the world and is present on the southern side of Asia?

Ans  1. Southern Ocean

2. Indian Ocean

3. Pacific Ocean

4. Bay of Bengal

Q.35 Which of the following is the most common nutritional cause of anaemia?

Ans  1. Iron deficiency

2. Calcium deficiency

3. Magnesium deficiency

4. Selenium deficiency

Q.36 According to Census of India 1901, what was the total population of India?

Ans  1. 238.40 million

2. 360.23 million

3. 620.12 million

4. 845.80 million

Q.37 Which of the following dimensions of liberty is NOT mentioned in the Preamble of the Constitution of India?

Ans  1. Belief

2. Opportunity

3. Expression

4. Thought

Q.38 Which phylum of the animal kingdom is made up of segmented insects like earthworms?

Ans  1. Nematoda

2. Platyhelminthes

3. Porifera

4. Annelida

Q.39 Which of the following money supply measures is commonly known as the aggregate monetary resources?

Ans  1. M2

2. M3

3. M1

4. M4

Q.40 Which of the following organisms belong to the Phylum Protozoa?

Ans  1. Amoeba, Paramecium, Jelly fish

2. Amoeba, Paramecium, Taenia

3. Euglena, Paramecium, Jelly fish

4. Amoeba, Paramecium, Plasmodium

Q.41 Olefiant gas belongs to which of the following functional groups?

Ans  1. Alkenes

2. Halo alkane

3. Alkynes

4. Ketone

Q.42 Which of the following statements is correct?

- Ans
- 1. A neutron has no electrical charge.
  - 2. The central part of an atom contains only protons.
  - 3. The central part of an atom contains only neutrons.
  - 4. The central part of an atom contains only electrons.

Q.43 Which of the following is used to remove formatting from a selected paragraph in many word processing programs?

- Ans
- 1. Clear Formatting
  - 2. Delete Paragraph
  - 3. Format Painter
  - 4. Remove Paragraph

Q.44 Which constitutional authority is appointed by the President of India under Article 76 of the Indian Constitution?

- Ans
- 1. Chief Election Commissioner
  - 2. Attorney General of India
  - 3. Comptroller & Auditor General of India
  - 4. Chief Justice of India

Q.45 Which ministry launched the KCC Ghar Ghar Abhiyaan in September 2023?

- Ans
- 1. Ministry of Agriculture and Farmers Welfare
  - 2. Ministry of Education
  - 3. Ministry of Women and Child Development
  - 4. Ministry of Housing and Urban Affairs

Q.46 Who was appointed as the first woman Chair person of the Railway Board by the Government of India on 31 August 2023?

- Ans
- 1. Jaya Verma Sinha
  - 2. Pooja Gupta
  - 3. Kanchan Chaudhary
  - 4. Smriti Zubin Irani

Q.47 Swaran Singh Committee was established by the government under which Prime Minister in 1976 to make recommendations regarding fundamental duties?

- Ans
- 1. Morarji Desai
  - 2. Indira Gandhi
  - 3. Jayaprakash Narayan
  - 4. Chaudhary Charan Singh

Q.48 Why cannot we write the chemical formula of a compound formed by chlorine and sodium as CINA instead of NaCl?

- Ans
- 1. The rule is to write the name of the metal first.
  - 2. Both the formulas are correct.
  - 3. Chlorine is lighter, hence is written at the end.
  - 4. Chlorine is yellow in colour.

Q.49 Who among the following was forced to leave his ancestral throne due to the invasion of the Uzbeks?

- Ans
- 1. Babur
  - 2. Genghis Khan
  - 3. Shershah Suri
  - 4. Daulat Khan Lodi



Q.50 Which juice is released in our gall bladder that facilitates the digestion of fats?

- Ans
- 1. Saliva
  - 2. Acetic Acid
  - 3. Bile
  - 4. Mucous

Section : General Engineering Civil and Structural

Q.1 The Los Angeles testing machine is commonly used to determine which property of the coarse aggregate?

- Ans
- 1. Water absorption
  - 2. Abrasion resistance
  - 3. Density
  - 4. Specific gravity

Q.2 Magnetic bearing of a line is  $10^{\circ} 30'$  and the magnetic declination is  $2^{\circ}$  East. If, due to seasonal variations, the magnetic declination changes to  $2^{\circ}$  West, find the magnetic bearing of the line in quadrantal bearing system.

- Ans
- 1. N  $10^{\circ} 30'$  W
  - 2. N  $14^{\circ} 30'$  E
  - 3. N  $10^{\circ} 30'$  E
  - 4. N  $14^{\circ} 30'$  W

Q.3 which of the following IS sieve size is used, to check the fineness of cement by sieve test?

- Ans
- 1. 90  $\mu\text{m}$
  - 2. 15  $\mu\text{m}$
  - 3. 37.5  $\mu\text{m}$
  - 4. 20  $\mu\text{m}$

Q.4 Ozone layer is important for us to protect us from UV rays. Which of the following is correct regarding ozone?

- Ans
- 1. Ozone is a pollutant gas for both animals and human beings.
  - 2. Ozone is a non-pollutant gas.
  - 3. Ozone is a pollutant gas for human beings and non-pollutant gas for animals.
  - 4. Ozone gets converted into oxygen in the human body.

Q.5 Which of the following types of soil is known for its high load-bearing capacity and stability, making it ideal for use in construction of foundations?

- Ans
- 1. Peat soil
  - 2. Silty soil
  - 3. Sandy soil
  - 4. Clay soil

Q.6 Identify whether the following statements are true or false.  
Statement I: Domestic sewage is a major source of water pollution.  
Statement II: Water collected/available at source will always be pure.

- Ans
- 1. Statement I is true, but Statement II is false
  - 2. Both Statements I and II are true
  - 3. Statement I is false and Statement II is true
  - 4. Both Statements I and II are false

Q.7 Tellurometer, a long-range EDM, uses \_\_\_\_\_ for distance measurement.

- Ans
- 1. infrared waves
  - 2. microwaves
  - 3. ultraviolet waves
  - 4. visible light waves

Q.8 In approximate quantities method of preparing approximate estimate, wall foundations are measured in \_\_\_\_\_.

- Ans
- 1. kilogram
  - 2. square metre
  - 3. metre
  - 4. cubic metre

Q.9 Match the major dams of India with their types.

Dam	Type
A. Bhakra Dam	1. Arch dam
B. Idukki Dam	2. Earthen dam
C. Banasura Sagar Dam	3. Gravity dam

- Ans
- 1. A-1, B-2, C-3
  - 2. A-3, B-1, C-2
  - 3. A-2, B-3, C-1
  - 4. A-3, B-2, C-1

Q.10 Which of the following types of fibre is classified as a synthetic fibre?

- Ans
- 1. Polyester fibre
  - 2. Jute fibre
  - 3. Steel fibre
  - 4. Basalt fibre

Q.11 Which of the following is the effect of lumps present in cement?

- Ans
- 1. Decreased setting time of cement
  - 2. Decreased strength in concrete
  - 3. Enhanced durability of concrete
  - 4. Flash set of concrete

Q.12 Identify the INCORRECT statement with respect to concrete Stress block in compression of a singly reinforced cement concrete section.

- Ans
- 1. The depth of centre of compressive force from the extreme top fibre in compression is  $0.42x_u$ .
  - 2. The area of stress block is equal to  $0.36f_k x_u$ .
  - 3. The bending stress at extreme fibre is  $0.67 f_k$ .
  - 4. The bending stress at the neutral axis of the section is zero.

Q.13 Calculate the hoop tension developed at the base of wall in a circular water tank, having diameter 12.6 m and depth of water storage 4m. Take specific weight of water as 10 kN/m<sup>3</sup>.

- Ans
- 1. 152 kN
  - 2. 252 kN
  - 3. 504 kN
  - 4. 200 kN

Q.14 Which section of reinforced concrete structure typically does NOT experience moment redistribution due to moment redistribution?

- Ans
- 1. Beam
  - 2. Slab
  - 3. Flat slabs
  - 4. continuous slab

Q.15 Which of the following signs does NOT fall into the category of regulatory signs?

- i. No Parking Signs
- ii. Speed Limit Signs
- iii. Stop Sign
- iv. Slippery Road
- v. Parking Sign

- Ans
- 1. Both i and v
  - 2. Only i, iv and v
  - 3. Both ii and iii
  - 4. Both iv and v

Q.16 As per IRC specifications, the maximum spacing of contraction joints in reinforced cement concrete slab of thickness 20 cm is \_\_\_\_\_.

- Ans
- 1. 14 m
  - 2. 10 m
  - 3. 4.5 m
  - 4. 40 m

Q.17 The priming of a centrifugal pump is necessary:

- Ans
- 1. to increase discharge
  - 2. to reduce pressure
  - 3. to remove air from the parts of the pump
  - 4. to reduce the temperature of water

Q.18 Two simply supported beams with central (mid span) concentrated loads have the following particulars. Compare the slope at the ends.

Particulars	Beam A	Beam B
Length of the beam	5 m	10 m
EI	EI	2EI
Value of central concentrated load	2 kN	1 kN

- Ans
- 1. Slope of beam A = Slope of beam B
  - 2. Slope of beam A < Slope of beam B
  - 3. Insufficient data to compare the slopes
  - 4. Slope of beam A > Slope of beam B

Q.19 While designing an RCC footing on soil, what should be the minimum thickness of the edge of footing as per IS 456:2000?

- Ans
- 1. 150 mm
  - 2. 50 mm
  - 3. 75 mm
  - 4. 200 mm

Q20 Self-priming pumps overshadow the function of the \_\_\_\_\_.

- Ans
- 1. corrosion device
  - 2. wear rate
  - 3. cavitation device
  - 4. self-auxiliary device

Q21 On what principle does a reciprocating pump work?

- Ans
- 1. Create a reciprocating motion by sucking and discharge of fluid by using piston
  - 2. Forced vortex flow
  - 3. Rotation of impeller to develop lifting pressure
  - 4. Centrifugal force

Q22 If a unit rotation is to be caused at end 'A' as shown in the figure, the far end being hinged support, a moment of \_\_\_\_\_ has to be applied at A, where, 'EI' is the flexural rigidity of beam. Take length of beam AB as 5 m.



- Ans
- 1.  $0.4 EI$
  - 2.  $0.3 EI$
  - 3.  $0.9 EI$
  - 4.  $0.6 EI$

Q23 The capacity of doing work by a skilled labour in the form of quantity of work per day is known as \_\_\_\_\_.

- Ans
- 1. lift work
  - 2. outturn work
  - 3. standard work
  - 4. extra work

Q24 The following is the data sheet from a levelling book. The INCORRECT option is \_\_\_\_\_.

Station	BS	IS	FS	RL	Remark
Q	-3.45			150	BM
R		2.60			
S	1.60		2.25		CP
T		1.85			
U	2.15		1.70		CP
V			-2.35		

BS = Back Sight, HI=Height of instrument, IS = Intermediate Sight, FS = Fore Sight, RL =Reduced Level, BM = Bench Mark and CP = Change Point)  
(All figures are in metre.)

- Ans
- 1. RL of Station S is 144.30 m
  - 2. HI at Station T is 145.90 m
  - 3. RL of Station U is 142.35 m
  - 4. HI at Station R is 146.55 m

Q25 Which of the following is NOT a field of application of rapid-hardening cement?

- Ans
- 1. Pre-fabricated concrete production
  - 2. Massive dams
  - 3. Road repair works
  - 4. Cold weather concreting

Q.26 According to Kennedy's theory, if the velocity of the flow is such that there is no silting or scouring action in the canal bed, then that velocity is known as \_\_\_\_\_.

- Ans
- 1. critical velocity
  - 2. normal velocity
  - 3. absolute velocity
  - 4. mean velocity

Q.27 Which of the following is NOT the main criterion for selection of hydraulic pumps?

- Ans
- 1. Pressure at inlet and outlet of the pump
  - 2. Viscosity of fluid to be pumped
  - 3. Flow rate requirement
  - 4. atmospheric pressure

Q.28 Select the option that is appropriate regarding the following two statements labelled Assertion and Reason.

**Assertion:** A cross regulator is provided on the main canal at the downstream side of the take-off to head up the water level and to enable the off-taking channel to draw the required amount of water.  
**Reason:** During the periods of low discharges in the parent channel, the cross regulator raises the water level of the upstream and feeds the off-take channel.

- Ans
- 1. Both Assertion and Reason are true and Reason is the correct explanation of Assertion.
  - 2. Both Assertion and Reason are false.
  - 3. Both Assertion and Reason are true, but Reason is not the correct explanation of Assertion.
  - 4. Assertion is true, but Reason is false.

Q.29 \_\_\_\_\_ determines the thickness of plywood board.

- Ans
- 1. plie length
  - 2. number of plie layers
  - 3. plie width
  - 4. plie area

Q.30 Timber can be treated to make it fire-resistant by which of the following processes?

- Ans
- 1. Seasoning process
  - 2. Coating with tar paint
  - 3. Applying creosote oil into timber
  - 4. Soaking it in ammonium sulphate

Q.31 What do the three Rs in the 3R Principle stand for?

- Ans
- 1. Reduce, Reuse, Recover
  - 2. Reduce, Reuse, Recycle
  - 3. Reduce, Recover, Recycle
  - 4. Recover, Reuse, Recycle

Q.32 Which of the following consistency limit of soil is indicated by rolling the soil into a thread of 3 mm, and it begins to crumble.

- Ans
- 1. Shrinkage limit
  - 2. Plastic limit
  - 3. Casagrande's limit
  - 4. Liquid limit

Q.33 Select the option that is appropriate regarding the following two statements labelled Assertion and Reason.  
Assertion: A gravity weir is the one in which uplift pressure caused by seepage of water below the floor is resisted entirely by the weight of the floor.  
Reason: In the non-gravity type weir, the floor thickness is kept relatively less and the uplift pressure is largely resisted by the bending action of the reinforced concrete floor.

- Ans
- 1. Both Assertion and Reason are true and Reason is the correct explanation of Assertion.
  - 2. Both Assertion and Reason are true, but Reason is not the correct explanation of Assertion.
  - 3. Both Assertion and Reason are false.
  - 4. Assertion is true, but Reason is false.

Q.34 For a given soil sample, with increase in compaction effort, the Optimum Moisture Content (OMC) ..... (Assume all other factors remain the same)

- Ans
- 1. first increases and then, decreases
  - 2. Decreases
  - 3. first decreases and then, increases
  - 4. Increases

Q.35 In a falling head test, the initial head level is 100 cm and the head level after 100 seconds is 10 cm. The area of cross-section of stand-pipe is 10 cm<sup>2</sup>, and the area of cross-section of soil sample is 100 cm<sup>2</sup>. Find the permeability of soil sample if the length of sample is 20 cm.

- Ans
- 1. 2.3 cm/s
  - 2. 0.023 cm/s
  - 3. 4.6 cm/s
  - 4. 0.046 cm/s

Q.36 Which of the following statements is INCORRECT?

- Ans
- 1. A cavity type tube well draws water from the bottom as well as from the sides of the well.
  - 2. The natural outflow of groundwater at the Earth's surface is said to form a spring.
  - 3. Surface sources of water are generally contaminated and cannot be used without treatment.
  - 4. Infiltration well is a sub-surface source of water.

Q.37 Which of the following statements about carbon credits is INCORRECT?

- Ans
- 1. The carbon credit system makes emissions a commodity.
  - 2. Carbon credits are created when greenhouse gases rise above a baseline.
  - 3. Carbon credits correspond to a determined tradable quantity of greenhouse gas emissions.
  - 4. Carbon credits are used in signatory countries to the Kyoto Protocol.

Q.38 Which type of lime is commonly used in soil stabilisation to improve the engineering properties of clay soils and enhance their load-bearing capacity?

- Ans
- 1. Dolomitic lime
  - 2. Hydrated lime or Quicklime
  - 3. Fat lime
  - 4. Slaked lime

Q.39 If water is flowing through a pipe of diameter 8 cm under 40 N/cm<sup>2</sup> of pressure and with 3 m/s of mean velocity, what will be the kinetic head? (Acceleration due to gravity is 10 m/s<sup>2</sup>.)

- Ans
- 1. 0.18 m
  - 2. 0.25 m
  - 3. 0.45 m
  - 4. 0.53 m

Q.40 What is the by-product that is formed by smelting Pig iron at 1500°C?

- Ans
- 1. Blast furnace slag
  - 2. Fly ash
  - 3. Surkhi
  - 4. Silica fume

Q.41 Which of the following statements about municipal solid waste is INCORRECT?

- Ans
- 1. It consists of garbage.
  - 2. It is solid waste that is transported with water as sewage.
  - 3. It consists of fine dust, silt and sand.
  - 4. It includes putrescible and non-putrescible solid wastes.

Q.42 Following the fundamental principles of surveying, the minimum number of control points required for establishing a new station is \_\_\_\_\_.

- Ans
- 1. 3
  - 2. 2
  - 3. 1
  - 4. 4

Q.43 Which of the following paints has the least adhesive power on smooth surface and is ideal for rough surfaces?

- Ans
- 1. Enamel paint
  - 2. Cement paint
  - 3. Aluminium paint
  - 4. Luminous paint

Q.44 A material has the modulus of elasticity equal to 3 times its modulus of rigidity. Which of the following statements may be INCORRECT?

- Ans
- 1. Poisson's ratio is equal to 0.5.
  - 2. Volumetric strain is equal to zero.
  - 3. There is a change in the volume of the material.
  - 4. The bulk modulus is infinite.

Q.45 Pumping of water from earth surface to the overhead tank located at relatively higher elevation is an example for\_\_\_\_\_

- Ans
- 1. pressure flow
  - 2. Compressible flow
  - 3. gravity flow
  - 4. both gravity flow and pressure flow

Q.46 Which of the following Informatory signs necessarily have rectangular/square shape with blue background and white/black letters or symbols?

- i.Speed limit signs
- ii.Facility Information signs
- iii.Parking signs

- Ans
- 1. Both i and ii
  - 2. Both ii and iii
  - 3. Only ii
  - 4. Only i

Q.47 If a cantilever beam is subjected to an upward point load at the free end, the nature of the stresses developed will be:

- Ans
- 1. compressive above the neutral axis and tensile below the neutral axis of the beam cross-section
  - 2. tensile above the neutral axis and compressive below the neutral axis of the beam cross-section
  - 3. tensile above as well as below the neutral axis of the beam cross-section
  - 4. compressive below as well as above the neutral axis of the beam cross-section

Q.48 Match the major dams of India with the rivers on which they are built.

Dam	River
A. Nagarjun Sagar Dam	1. Bhagirathi
B. Hirakud Dam	2. Krishna
C. Tehri Dam	3. Mahanadi

- Ans
- 1. A-2, B-1, C-3
  - 2. A-2, B-3, C-1
  - 3. A-1, B-2, C-3
  - 4. A-1, B-3, C-2

Q.49 The \_\_\_\_\_ process is a type of process mainly used to recover energy from solids in one form or another.

- Ans
- 1. chemical
  - 2. biological
  - 3. thermal
  - 4. pressure



Q.50 Select the option that is appropriate regarding the following two statements labelled Assertion and Reason.

**Assertion:** A channel should be designed for a velocity that will neither deposit the sediment nor scour the bed and banks. This velocity is known as non-scouring and non-silting velocity.

**Reason:** If the velocity of flow is too low, the sediment held in suspension will settle down; whereas, if the velocity is too high, the water will scour the bed and sides of the canal.

- Ans
- 1. Both Assertion and Reason are true and Reason is the correct explanation of Assertion.
  - 2. Both Assertion and Reason are true, but Reason is not the correct explanation of Assertion.
  - 3. Assertion is true, but Reason is false.
  - 4. Both Assertion and Reason are false.

Q.51 **Compaction Test 1-** Weight of hammer = 10 kg, Height of fall = 500 mm, Number of layers = 3, Number of blows per layer = 25.  
**Compaction Test 2-** Weight of hammer = 5 kg, Height of fall = 250 mm, Number of layers = 6, Number of blows per layer = 25.  
The ratio of compactive energy of compaction test 1 to that of compaction test 2 is:

- Ans
- 1. 2
  - 2. 8
  - 3. 4
  - 4. 0.5

Q.52 A sample of soil failed in a triaxial test under a deviator stress of 200 kN/m<sup>2</sup> when the confining pressure was 100 kN/m<sup>2</sup>. For the sample, if the confining pressure had been 200 kN/m<sup>2</sup>, what would have been the deviator stress at failure? Assume  $c = 0$ .

- Ans
- 1. 400 kN/m<sup>2</sup>
  - 2. 100 kN/m<sup>2</sup>
  - 3. 600 kN/m<sup>2</sup>
  - 4. 500 kN/m<sup>2</sup>

Q.53 In the case design of an axially loaded short RCC column, the meaning of axial loading refers to:

- Ans
- 1. uniform compressive strain distribution across the cross section
  - 2. non-uniform compressive strain distribution across the cross section
  - 3. non-uniform tensile strain distribution across the cross section
  - 4. uniform tensile strain distribution across the cross section

Q.54 Which of the following laws states that the compressive strength of hardened concrete is inversely proportional to the water-cement ratio, when the concrete mix is of workable consistency?

- Ans
- 1. Archimede's Law
  - 2. Abram's Law
  - 3. Coulomb's Law
  - 4. Avogadro's Law

Q.55 Which of the following compounds gives rapid hardening with an early gain in strength with a higher heat of hydration in OPC Cement?

- Ans
- 1. C<sub>3</sub>A
  - 2. C<sub>3</sub>S
  - 3. C<sub>4</sub>AF
  - 4. C<sub>2</sub>S

Q.56 The value of nominal shear stress for beam of varying depth is given by \_\_\_\_\_.

- Ans
- 1.  $\frac{V_u \mp \frac{d}{M_u} \tan \beta}{bd}$
  - 2.  $\frac{V_u \mp \frac{M_u}{d} \tan \beta}{b}$
  - 3.  $\frac{V_u \mp \frac{M_u}{d} \tan \beta}{bd}$
  - 4.  $\frac{V_u \mp \frac{d}{M_u} \tan \beta}{b}$

Q.57 In which of the processes of manufacturing of cement is the limestone brought from the quarries first crushed into smaller fragments?

- Ans
- 1. Grinding process
  - 2. Wet process
  - 3. Dry process
  - 4. Moist process

Q.58 The Moody chart, a logarithmic chart between friction factor and \_\_\_\_\_ for a variety of relative roughness in a pipe flow.

- Ans
- 1. the discharge of the flow
  - 2. the density of the fluid
  - 3. the velocity of the flow
  - 4. Reynolds number

Q.59 Which of the following tools is used to check the difference in cross levels or the superelevation in a highway?

- Ans
- 1. Cow bar
  - 2. Canne-a-boule
  - 3. Cant board
  - 4. Cant bar

Q.60 Which of the following scenario explains the term 'skid' experienced by vehicles?

- Ans
- 1. Occurs when a wheel revolves more than the corresponding longitudinal movement.
  - 2. Occurs when driving wheel of a vehicle rapidly accelerates from stationary position.
  - 3. Occurs when path travelled along road surface is more than circumferential movement of the wheels due to their rotation.
  - 4. It occurs when the roads surface is rough and develop sufficient frictional resistance

Q.61 As per IS 800:2007, the slenderness ratio ( $\lambda$ ) of a steel member is given by \_\_\_\_\_. Where, L=Effective length of member, r=Radius of gyration of member.

- Ans
- 1.  $\lambda = L \times r$
  - 2.  $\lambda = L - r$
  - 3.  $\lambda = L / r$
  - 4.  $\lambda = L + r$

Q.62 What are the latitude and the departure of a 300 m traverse line with a bearing of  $240^\circ$ ?

- Ans
- 1. Latitude = 150 m and departure =  $\frac{450}{\sqrt{3}}$  m
  - 2. Latitude =  $-\frac{450}{\sqrt{3}}$  m and departure = - 150 m
  - 3. Latitude =  $\frac{450}{\sqrt{3}}$  m and departure = 150 m
  - 4. Latitude = - 150 m and departure =  $-\frac{450}{\sqrt{3}}$  m

Q.63 Match the following.

Treatment	Objective of Treatment
I. Skimming tank	A. To remove floating objects
II. Detritus tank	B. To remove finer particles
III. Screening	

- Ans
- 1. I-A, II-B, III-A
  - 2. I-B, II-B, III-A
  - 3. I-A, II-B, III-B
  - 4. I-A, II-A, III-A

Q.64 What is the use of an electrostatic precipitator?

- Ans
- 1. Gaseous pollutant control
  - 2. Vehicular pollutant control
  - 3. Particulate pollutant control
  - 4. Domestic pollutant control

Q.65 For a very deep footing in loose sand, the type of soil failure will be:

- Ans
- 1. punching shear failure
  - 2. general shear failure
  - 3. local shear failure
  - 4. cracking shear failure

Q.66 A simply supported RCC beam of effective length 5 m and section of size 200 mm  $\times$  300 mm is having flexural strength of 18 kN-m. Calculate the maximum external udl that can be applied to the beam before failure. Take self-weight as 1 kN/m.

- Ans
- 1. 6.76 kN/m
  - 2. 4.76 kN/m
  - 3. 5.76 kN/m
  - 4. 3.76 kN/m

Q.67 Surrounding atmospheric pressure is taken as datum to find\_\_\_\_\_

- Ans
- 1. gauge pressure
  - 2. absolute pressure
  - 3. Null pressure
  - 4. vacuum pressure

Q.68 Identify the correct option by considering the given statements with respect to overtaking sight distance.

Statement A: Minimum overtaking sight distance required for the safe overtaking manoeuvre depends on skill and reaction time of driver.

Statement B: Minimum overtaking sight distance required for the safe overtaking manoeuvre depends on gradient of road.

- Ans
- 1. Both the statements are incorrect
  - 2. Statement A is correct, but B is incorrect
  - 3. Both the statements are correct
  - 4. Statement B is correct, but A is incorrect

Q.69 In which of the following staircase classifications is the stair slab supported parallel to the riser at two or more locations, causing the slab to bend longitudinally between the supports?

- Ans
- 1. Slab supported between two stringer beams or walls
  - 2. Slab doubly cantilevered from a central spine beam
  - 3. Stair slab spanning longitudinally
  - 4. Slab cantilevered from a spandrel beam or wall

Q.70 The main components of a hydrological cycle can be classified as transportation components and storage components. An example of a storage component of the hydrological cycle is \_\_\_\_\_.

- Ans
- 1. groundwater
  - 2. transpiration
  - 3. runoff
  - 4. precipitation

Q.71 Which of the following parts of a rebound test apparatus moves with the mass attached to the spring after bouncing back?

- Ans
- 1. Plunger
  - 2. Release button
  - 3. Rider
  - 4. Scale

Q.72 How much deduction should be made in the hollows of blocks during a hollow concrete block wall construction?

- Ans
- 1. No deduction
  - 2. All openings
  - 3. Half of the openings
  - 4. Width deduction

Q.73 The formal acceptance of the proposal of a work by the concerned department is known as \_\_\_\_\_.

- Ans
- 1. proposal approval
  - 2. preliminary approval
  - 3. administrative approval
  - 4. technical approval

Q.74 Using plinth area method, estimate the construction cost of a building having plinth area of 15 m<sup>2</sup>, if the plinth area rate is Rs.2000/- per m<sup>2</sup>.

- Ans
- 1. ₹15,000
  - 2. ₹30,000
  - 3. ₹25,000
  - 4. ₹20,000

Q.75 An oil of mass density  $800 \text{ kg/m}^3$  is contained in a vessel. Calculate the height of water required to develop an equivalent hydrostatic pressure as that developed by oil of height 30 m. Take acceleration due to gravity as  $9.81 \text{ m/sec}^2$

- Ans
- 1. 42 m
  - 2. 23 m
  - 3. 32 m
  - 4. 24 m

Q.76 Which of the following is the purpose of providing catch pits in a sewer system?

- Ans
- 1. To provide a connection between the high-level branch sewer to the low-level main sewer
  - 2. To hold and throw water into the sewer
  - 3. To exclude grease and oil from sewage
  - 4. To prevent the entry of silt, grit, debris, etc. contained in the rainwater

Q.77 Which of the following statements gives an INCORRECT application of GPS?

- Ans
- 1. GPS can be used to determine the time accurately.
  - 2. GPS can be used for preparation of maps.
  - 3. GPS can be used to track the movement of vehicles.
  - 4. GPS can be used to determine the position of a point in deep, underground mines.

Q.78 Consider a rectangular column cross section of size  $4 \text{ m} \times 2 \text{ m}$ . Identify the correct statement.

- Ans
- 1. The core of the section is a square of size 0.6 m.
  - 2. The point load shall be applied within the rhombus located at centre with diagonals size  $1.33 \text{ m} \times 0.66 \text{ m}$  to ensure no tensile stresses developed in column cross section
  - 3. The limit of eccentricity for axial compressive load is 1 m measured from the C.G of the cross section for not to have tensile stresses in the section.
  - 4. The point load shall be applied within the 1.5 m from the centre to avoid tension in the cross section.

Q.79 The coefficient of permeability has the same unit as that of \_\_\_\_\_.

- Ans
- 1. acceleration
  - 2. force
  - 3. hydraulic gradient
  - 4. velocity

Q.80 Which of the following type of asphalt is better suited for surface sealing and dust control in flexible pavements?

- Ans
- 1. Hot mix asphalt
  - 2. Cold mix asphalt
  - 3. Emulsified asphalt
  - 4. Cutback asphalt

Q.81 During the calibration of a rectangular suppressed weir in a 40 cm crest width laboratory channel, the discharge passing over the weir was measured volumetrically. What is the coefficient of discharge of the weir if it was found to pass a discharge of 0.025 m<sup>3</sup>/sec under the head of 0.1 m?

- Ans
- 1.  $C_d = 0.75$
  - 2.  $C_d = 0.66$
  - 3.  $C_d = 0.89$
  - 4.  $C_d = 0.92$

Q.82 If the load on an RCC lintel due to the wall above it is in the form of a triangular portion, then the angle subtended by a triangle at either end of the lintel shall be:

- Ans
- 1. 50 degrees each
  - 2. 60 degrees each
  - 3. 30 degrees each
  - 4. 40 degrees each

Q.83 As per the Indian standard code (2470 - 1985, Part 1), the minimum width of the septic tank assumed for design purpose is \_\_\_\_\_.

- Ans
- 1. 125 cm
  - 2. 75 cm
  - 3. 100 cm
  - 4. 50 cm

Q.84 The sound pressure is measured in:

- Ans
- 1. hertz
  - 2. N/m<sup>2</sup>
  - 3. decibel
  - 4. watt

Q.85 Calculate the effective depth of a cantilever beam of span 2.5m, based on the provisions given on 'effective depth ratios for spans up to 10m' in IS 456 : 2000

- Ans
- 1. 357.14 mm
  - 2. 250 mm
  - 3. 457 mm
  - 4. 500 mm

Q.86 Which of the following is an efficient method of levelling that should be adopted to measure the elevation of two points when the distance between them is NOT within the visible range of the level?

- Ans
- 1. Profile levelling
  - 2. Reciprocal levelling
  - 3. Differential levelling
  - 4. Block levelling

Q.87 Find the quantity of brickwork for underground septic tank shown in the given figure.

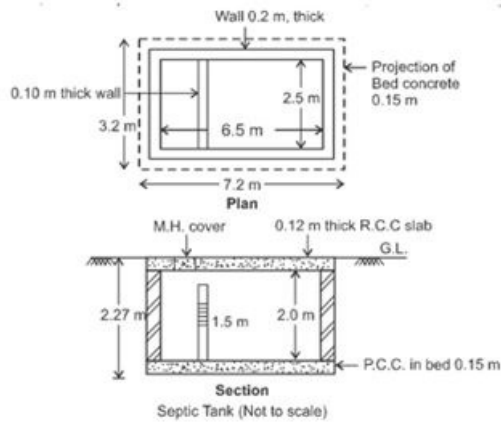

- Ans
- 1. 7.895 m<sup>3</sup>
  - 2. 10.641 m<sup>3</sup>
  - 3. 6.415 m<sup>3</sup>
  - 4. 9.673 m<sup>3</sup>



Q.88 Select the option that is appropriate regarding the following two statements labelled Assertion and Reason.  
**Assertion:** The season wherein crops are sown by the beginning of south west monsoon and harvested in autumn is called Kharif season.  
**Reason:** The Kharif season ranges from October to March.

- Ans
- 1. Both Assertion and Reason are false.
  - 2. Both Assertion and Reason are true and Reason is the correct explanation of Assertion.
  - 3. Assertion is true, but Reason is false.
  - 4. Both Assertion and Reason are true, but Reason is not the correct explanation of Assertion.

Q.89 When an economical canal cross-section is formed partly in cutting and partly in filling, such that the quantity of earth in cutting is equal to the quantity of earth in filling, the depth of cutting under that situation is known as \_\_\_\_\_ .

- Ans
- 1. Balancing depth
  - 2. Uniform depth
  - 3. Critical depth
  - 4. Economical depth

Q.90 As per Euler's theory, for which of the following end conditions is the longest effective length of a column obtained?

- Ans
- 1. When one end of the column is fixed and the other end is hinged
  - 2. When one end of the column is fixed and the other end is free
  - 3. When both the ends of the column are fixed
  - 4. When both the ends of the column are hinged

Q.91 What are fixed time traffic signals?

- Ans
- 1. Signals that change timing based on traffic flow
  - 2. Signals that adjust timing based on weather conditions
  - 3. Signals that are manually controlled by a traffic officer
  - 4. Signals that have a fixed duration for each phase

Q.92 Which of the following precautions need to be adopted for concreting in sub-zero temperature?

- (i) Pre-heating of materials of concrete
- (ii) Economical heating of materials of concrete
- (iii) Admixtures of anti-freezing materials
- (iv) Electrical heating of concrete mass

- Ans
- 1. (i), (ii), (iii), and (iv)
  - 2. Only (i)
  - 3. Only (i), (ii), (iii)
  - 4. Only (i) and (ii)

Q.93 Identify the correct methods of surface preparation used for joining old and new concrete to each other.

- i) Sandblasting
- ii) Chipping
- iii) Removal of surface by grinding

- Ans
- 1. Only i
  - 2. Only ii
  - 3. All of i, ii and iii
  - 4. Only i and ii

Q.94 A high steep camber is NOT desirable to:

- Ans
- 1. prevent entry of water into bituminous pavement layers
  - 2. transverse tilt and skid of vehicle
  - 3. prevent the entry of surface water into subgrade soil
  - 4. remove rain water from pavement surface

Q.95 As per Indian Road Congress, what is the design speed adopted for Indian Expressways?, Consider the nature of terrain is 'Plain' and Cross slope of ground is less than 10%.

- Ans
- 1. 80 km/h
  - 2. 120 km/h
  - 3. 100 km/h
  - 4. 60 km/h



Q.96 Which of the following is correct expression to find the hypotenusal allowance used to compute horizontal distance on a sloping ground?, where  $\Theta$ =Angle of sloped ground

- Ans
- 1. Measured length on sloped ground( $1-\cos\Theta$ )
  - 2. Measured length on sloped ground( $1-\cos\Theta$ )
  - 3. Measured length on sloped ground( $1-\sec\Theta$ )
  - 4. Measured length on sloped ground( $\sec\Theta -1$ )

Q.97 In approximate quantity method of estimation, earthwork excavation is measured in \_\_\_\_\_.

- Ans
- 1. cubic feet
  - 2. square metre
  - 3. running metre
  - 4. cubic metre

Q.98 How does the atmospheric pressure (AP) vary with respect to the altitude?

- Ans
- 1. AP increases with increase in altitude
  - 2. It remains constant at all heights
  - 3. AP either increases or decreases depending only on temperature
  - 4. AP decreases with increase in altitude

Q.99 Which of the following staff readings is/are taken at a turning point, that necessitates instruments change point in levelling work?

- A)Fore sight
- B)Back sight
- C)Intermediate sight

- Ans
- 1. Both A and C
  - 2. Both A and B
  - 3. Only A
  - 4. Only B

Q.100 To obtain the liquid limit of a soil, a graph is plotted between :

- Ans
- 1. water content and number of blows
  - 2. volume of soil and water content
  - 3. void ratio of soil and number of blows.
  - 4. dry density and water content

## Junior Engineer Civil Mechanical and Electrical Examination 2024 Paper I

Exam Date	05/06/2024
Exam Time	5:00 PM - 7:00 PM
Subject	Junior Engineer 2024 Electrical Paper I

### Section : General Intelligence and Reasoning

Q1 In a certain code language, 'TAKERS' is coded as '045%^1' and 'TALKER' is coded as '1\*450%'. What is the code for 'L' in the given code language?

- Ans
- 1. ^
  - 2. 0
  - 3. 5
  - 4. \*

Q2 In a Zoological park, seven giraffes L, M, R, E, V, Z and Y have different heights. R is taller than E but shorter than Y. Z is taller than M but shorter than V. L is taller than R but shorter than V. Y is shorter than M but taller than E. M is shorter than Z. Which among the seven is the shortest?

- Ans
- 1. E
  - 2. Y
  - 3. L
  - 4. R

Q3 What should come in place of the question mark (?) in the given series based on the English alphabetical order?  
HNL, JPN, LRP, NTR, ?

- Ans
- 1. VPT
  - 2. VTP
  - 3. PTV
  - 4. PVT

Q4 What should come in place of the question mark (?) in the given series based on the English alphabetical order?  
RJG, NFC, JBY, FXU, ?

- Ans
- 1. BSQ
  - 2. ATQ
  - 3. ATP
  - 4. BTQ

Q5 What should come in place of the question mark (?) in the given series?  
14, 19, 29, 44, 64, ?

- Ans
- 1. 84
  - 2. 82
  - 3. 88
  - 4. 89

Q6 GKHL is related to IMJN in a certain way based on the English alphabetical order. In the same way, KOLP is related to MQNR. To which of the following is NROS related, following the same logic?

- Ans
- 1. TPUQ
  - 2. PTUQ
  - 3. PTQU
  - 4. TPQU

Q.7 What should come in place of the question mark (?) in the given series based on the English alphabetical order?  
SVX, QTV, ORT, MPR, ?

- Ans
- 1. NRP
  - 2. KMP
  - 3. LOR
  - 4. KNP

Q.8 Select the correct mirror image of the given figure when the mirror is placed at MN as shown below.

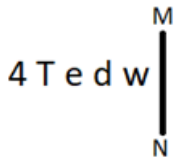

- Ans
- 1. w p e l t
  - 2. w b e T 4
  - 3. m d e T 4
  - 4. w b e 4 T

Q.9 Aishwarya starts from her office in north direction. She turns to her left then to her right and finally after walking some more, she turns to her left. In which direction is she facing now?

- Ans
- 1. North
  - 2. East
  - 3. South
  - 4. West

Q.10 In a certain code language, 'BANISH' is coded as '9' and 'AMORPHOUS' is coded as '12'. What is the code for 'AMNESTY' in the given language?

- Ans
- 1. 11
  - 2. 9
  - 3. 16
  - 4. 10

Q.11 Select the option figure that will replace the question mark (?) in the figure given below to complete the pattern.

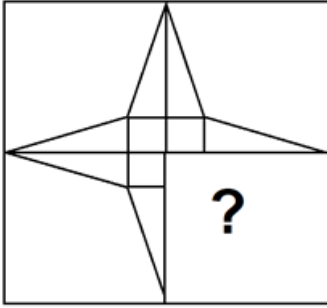

Ans

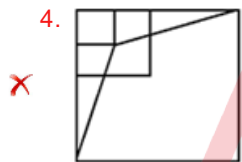
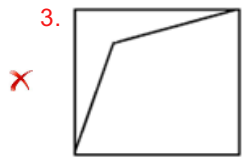
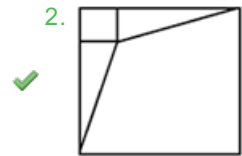
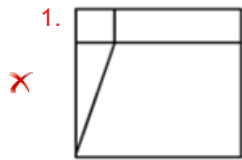

Q.12 In a certain code language, 'he was good' is coded as 'ik bu oy' and 'was she there' is coded as 'bu ha no'. How is 'was' coded in the given language?

- Ans
- 1. ha
  - 2. bu
  - 3. no
  - 4. ik

Q.13 The position of how many letters will remain unchanged if each of the letters in the word CLOSURE is arranged in the English alphabetical order?

- Ans
- 1. One
  - 2. Two
  - 3. Three
  - 4. Four

Q.14 In a certain code language,  
'A + B' means 'A is the mother of B',  
'A - B' means 'A is the brother of B',  
'A × B' means 'A is the wife of B', and  
'A ÷ B' means 'A is the father of B'.  
How is T related to O if 'P + N - S ÷ O + M × T'?

- Ans
- 1. Son
  - 2. Son's son
  - 3. Daughter's husband
  - 4. Daughter's son

Q.15 Which of the following numbers will replace the question mark (?) in the given series?  
30, 31, 36, 45, 62, ?

- Ans
- 1. 88
  - 2. 87
  - 3. 90
  - 4. 85

Q.16 L, M, N, O, P and Q are sitting around a circular table facing the centre (not necessarily in the same order). M is sitting to the immediate right of Q. L is sitting to the immediate left of O. Q is sitting to the immediate right of O. P is sitting to the immediate left of L. Who is sitting to the immediate right of M?

- Ans
- 1. N
  - 2. P
  - 3. L
  - 4. O

Adda247

Q.17 Select the option in which the given figure is embedded (rotation is NOT allowed).

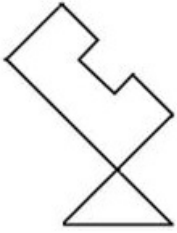

Ans

1.

✗

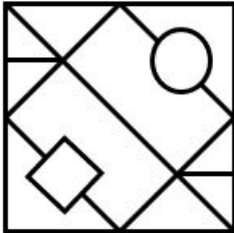

2.

✗

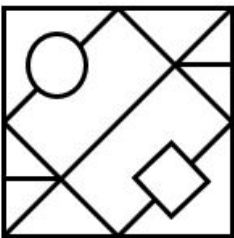

3.

✗

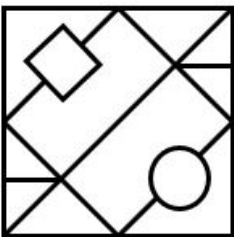

4.

✓

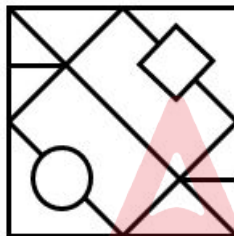

Q.18 MK 4 is related to OM 2 in a certain way. In the same way, QS 6 is related to SU 3. To which of the following is XU 8 related, following the same logic?

Ans

✗ 1. GX 5

✗ 2. ST 5

✓ 3. ZW 4

✗ 4. XE 7

Q.19 16 is related to 225 following a certain logic. Following the same logic, 7 is related to 99. To which of the following is 11 related following the same logic?  
(NOTE: Operations should be performed on the whole numbers, without breaking down the numbers into their constituent digits. E.g. 13 – Operations on 13 such as adding / subtracting /multiplying to 13 can be performed. Breaking down 13 into 1 and 3 and then performing mathematical operations on 1 and 3 is not allowed.)

- Ans
- 1. 155
  - 2. 159
  - 3. 158
  - 4. 150

Q.20 Which two numbers should be interchanged to make the given equation correct?  
 $(176 \div 4) + (22 \times 8) - (2 \times 20) = 70$   
(Note: Interchange should be done of entire number and not individual digits of a given number)

- Ans
- 1. 4 and 8
  - 2. 2 and 4
  - 3. 22 and 20
  - 4. 2 and 8

Q.21 What will come in place of the question mark (?) in the following equation if '+' and '-' are interchanged?  
 $63 \div 9 - 14 \times 11 + 28 = ?$

- Ans
- 1. 135
  - 2. 138
  - 3. 133
  - 4. 129

Q.22 Read the given statements and conclusions carefully. You have to take the given statements to be true even if they seem to be at variance from commonly known facts. You have to decide which conclusion/s logically follow/s from the given statements.

Statements: Some horses are rocks. Some rocks are leaves. No rock is a tree.

Conclusions:

- (I) No horse is a tree.
- (II) At least some leaves are trees.

- Ans
- 1. Only conclusion (II) follows.
  - 2. Both conclusions (I) and (II) follow.
  - 3. Only conclusion (I) follows.
  - 4. Neither conclusion (I) nor (II) follows.

Q23 L, M, N, O, P, Q, and R are sitting around a circular table, facing the centre. L sits second to the right of M. N sits third to the right of L. O sits second to the left of N. P is not an immediate neighbour of N. Q sits to the immediate right of O. How many people are sitting between L and R when counted from the left of L?

- Ans
- 1. Three
  - 2. One
  - 3. Zero
  - 4. Two

Q24 In a certain code language,  
 'A + B' means 'A is the mother of B',  
 'A = B' means 'A is the brother of B',  
 'A × B' means 'A is the wife of B' and  
 'A > B' means 'A is the father of B'.  
 How is P related to T if 'P + Q × R > S = T'?

- Ans
- 1. Mother's sister
  - 2. Father's mother's sister
  - 3. Mother's mother
  - 4. Father's mother

Q25 Select the correct mirror image of the given figure when the mirror is placed at OG as shown below.

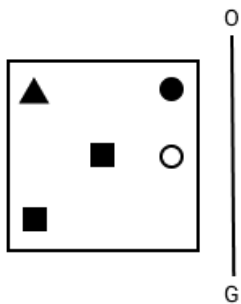

- Ans
- 1.
  - 2.
  - 3.
  - 4.



Q.26 Select the correct option that indicates the arrangement of the following words in a logical and meaningful order.

1. School
2. Graduation
3. Birth
4. Doctorate
5. Under-graduation

Ans  1. 3, 1, 5, 2, 4  
 2. 1, 5, 3, 2, 4  
 3. 4, 1, 3, 2, 5  
 4. 3, 5, 1, 4, 2

Q.27 In a certain code language, 'HIDE' is coded as '3795' and 'DOWN' is coded as '4287'.  
What is the code for 'D' in the given code language?

Ans  1. 4  
 2. 9  
 3. 2  
 4. 7

Q.28 FJGK is related to HLIM in a certain way based on the English alphabetical order. In the same way, IMJN is related to KOLP. To which of the following is OSPT related, following the same logic?

Ans  1. QVUR  
 2. QUVR  
 3. QVRU  
 4. QURV

Q.29 The position(s) of how many letters will remain unchanged if each of the letters in the word 'HANGOVER' is arranged in alphabetical order?

Ans  1. Zero  
 2. Three  
 3. Two  
 4. Four

Q.30 42 is related to 14 following a certain logic. Following the same logic, 33 is related to 11. To which of the following is 75 related following the same logic?

(NOTE: Operations should be performed on the whole numbers, without breaking down the numbers into its constituent digits. E.g. 13 – Operations on 13 such as adding /subtracting /multiplying etc. to 13 can be performed. Breaking down 13 into 1 and 3 and then performing mathematical operations on 1 and 3 is not allowed.)

Ans  1. 15  
 2. 25  
 3. 35  
 4. 45

Q.31 Select the correct option that indicates the arrangement of the following words in a logical and meaningful order.

1. House
2. Curtain
3. Window
4. Room
5. Wall

- Ans
- 1. 1, 2, 3, 5, 4
  - 2. 1, 5, 2, 4, 3
  - 3. 1, 3, 4, 2, 5
  - 4. 1, 4, 5, 3, 2

Q.32 Read the given statements and conclusions carefully. Assuming that the information given in the statements is true, even if it appears to be at variance with commonly known facts, decide which of the given conclusion(s) logically follow(s) from the statements.

Statements: Some pens are red. All red are blue.

Conclusion 1: All pens are blue.

Conclusion 2: Some pens are not red.

- Ans
- 1. Neither conclusion 1 nor 2 follows
  - 2. Both conclusion 1 and 2 follow
  - 3. Only conclusion 2 follows
  - 4. Only conclusion 1 follows

Q.33 If A means +, B means −, C means × and D means ÷, then what will come in place of the question mark (?) in the following equation?  
21 A 18 D 2 B 3 C 5 = ?

- Ans
- 1. 16
  - 2. 15
  - 3. 17
  - 4. 14

Q.34 What should come in place of the question mark (?) in the given series?

25, 30, 40, 55, 75, ?

- Ans
- 1. 90
  - 2. 95
  - 3. 100
  - 4. 105

Q.35 What should come in place of the question mark (?) in the given series based on the English alphabetical order?

STA, WXE, ABI, EFM, ?

- Ans
- 1. JIS
  - 2. IJQ
  - 3. JPS
  - 4. KKP

Q.36 Select the set in which the numbers are related in the same way as are the numbers of the following sets.

(NOTE: Operations should be performed on the whole numbers, without breaking down the numbers into its constituent digits. E.g. 13 – Operations on 13 such as adding/subtracting/multiplying etc. to 13 can be performed. Breaking down 13 into 1 and 3 and then performing mathematical operations on 1 and 3 is not allowed.)

(120, 96, 54)

(108, 84, 42)

- Ans
- 1. (124, 100, 58)
  - 2. (116, 92, 62)
  - 3. (92, 68, 40)
  - 4. (128, 96, 60)

Q.37 Select the word-pair that best represents a similar relationship to the one expressed in the pair of words given below.  
(The words must be considered as meaningful English words and must not be related to each other based on the number of letters/number of consonants/vowels in the word.)

Cockroach : Nymph

- Ans
- 1. Sheep : Fawn
  - 2. Swan : Cygnet
  - 3. Bear : Foal
  - 4. Horse : Chick

Q.38 Select the option in which the numbers share the same relationship as that shared by the given pairs of numbers.

100 : 20

60 : 12

(NOTE: Operations should be performed on the whole number, without breaking down the numbers into its constituent digits. E.g. 13- Operations on 13 such as adding/subtracting/multiplying etc. to 13 can be performed. Breaking down 13 into 1 and 3 and then performing mathematical operations on 1 and 3 is NOT allowed.)

- Ans
- 1. 120 : 12
  - 2. 144 : 12
  - 3. 54 : 6
  - 4. 45 : 9

Q.39 TILE is related to VLNH in a certain way based on the English alphabetical order. In the same way, RAMP is related to TDOS. To which of the following is SORT related, following the same logic?

- Ans
- 1. VRTV
  - 2. URTW
  - 3. VRTW
  - 4. URTV

Q.40 What should come in place of the question mark (?) in the given series based on the English alphabetical order?  
HLP, TXB, FJN, RVZ, DHL, ?

- Ans
- 1. QTY
  - 2. QSX
  - 3. PTX
  - 4. PTY

Q.41 KSNJ is related to MUPL in a certain way based on the English alphabetical order. In the same way, NVQM is related to PXSO. To which of the following is EMHD related, following the same logic?

- Ans
- 1. GOJF
  - 2. GOFJ
  - 3. OGJF
  - 4. OGFJ

Q.42 What will come in place of the question mark (?) in the following equation if '+' and '-' are interchanged and 'x' and '÷' are interchanged?

$$20 \times 5 - 13 + 3 \div 4 = ?$$

- Ans
- 1. 10
  - 2. 12
  - 3. 5
  - 4. 7

Q.43 Select the option figure in which the given figure is embedded as its part (rotation is NOT allowed).



Ans

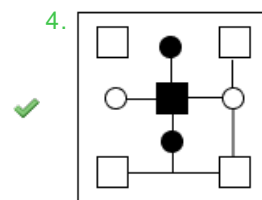
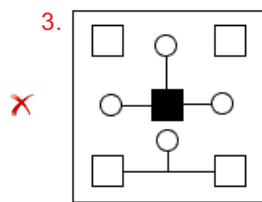
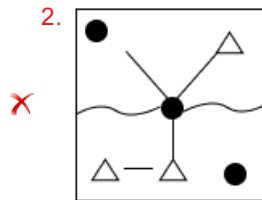
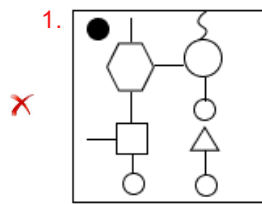

Q.44 What should come in place of the question mark (?) in the given series based on the English alphabetical order?

MGA, HBV, CWQ, XRL, ?

- Ans
- 1. SGM
  - 2. SMG
  - 3. GMS
  - 4. GSM

Q.45 Rahul walked 20 m towards the north. Then he turned right and walked 20 m. Then he turned right and walked 10 m. He then turned right and walked 10 m. In what direction is he headed?

- Ans
- 1. East
  - 2. West
  - 3. North
  - 4. South

Q.46 HGCA is related to LKGE in a certain way based on the English alphabetical order. In the same way, BKOM is related to FOSQ. To which of the following is NSJD related, following the same logic?

- Ans
- 1. HSRD
  - 2. RWNH
  - 3. PLNH
  - 4. LPRY

Q.47 How many triangles are there in the given figure?

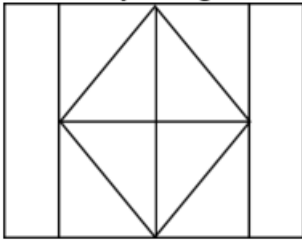





- Ans
- 1. 18
  - 2. 14
  - 3. 12
  - 4. 16

Q.48 Select the set in which the numbers are related in the same way as are the numbers of the following sets.  
 (NOTE: Operations should be performed on the whole numbers, without breaking down the numbers into its constituent digits. E.g. 13 – Operations on 13 such as adding/subtracting/multiplying etc. to 13 can be performed. Breaking down 13 into 1 and 3 and then performing mathematical operations on 1 and 3 is not allowed.)  
 (12, 8, 28)  
 (34, 9, 52)

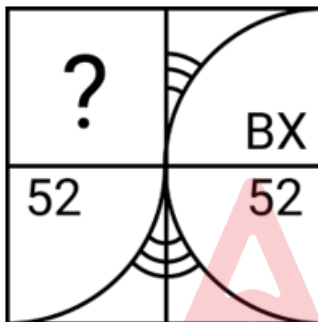
- Ans
- 1. (15, 25, 60)
  - 2. (54, 13, 70)
  - 3. (49, 12, 71)
  - 4. (62, 11, 84)

Q.49 Select the figure from the options that can replace the question mark (?) and complete the given pattern.

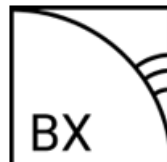

- Ans
- 1.  
  - 2.  
  - 3.  
  - 4.  

Q.50 42 is related to 21 following a certain logic. Following the same logic, 26 is related to 13. To which of the following is 68 related following the same logic?

(NOTE: Operations should be performed on the whole numbers, without breaking down the numbers into its constituent digits. E.g. 13 – Operations on 13 such as adding /subtracting /multiplying etc. to 13 can be performed. Breaking down 13 into 1 and 3 and then performing mathematical operations on 1 and 3 is not allowed.)

- Ans
- 1. 30
  - 2. 32
  - 3. 34
  - 4. 36

Section : General Awareness

Q.1 The animals or plants which can inbreed successfully must belong to the same \_\_\_\_\_.

- Ans
- 1. locality
  - 2. planet
  - 3. country
  - 4. species

Q.2 In which Union Territory is the 'slash and burn' agriculture known as 'Dipa'?

- Ans
- 1. Ladakh
  - 2. Dadra & Nagar Haveli and Daman & Diu
  - 3. Andaman and Nicobar Islands
  - 4. Jammu and Kashmir

Q.3 In which year was the Integrated Child Development Scheme (ICDS) launched in India?

- Ans
- 1. 1984
  - 2. 1978
  - 3. 1982
  - 4. 1975

Q.4 The Arid soils are developed in the western part of which state from the following?

- Ans
- 1. Assam
  - 2. Telangana
  - 3. Rajasthan
  - 4. Bihar

Q.5 Who among the following scientists discovered free living cells in pond water for the first time?

- Ans
- 1. Robert Brown
  - 2. Robert Hooke
  - 3. Anton Van Leeuwenhoek
  - 4. Franz Bauer

Q.6 In the 1830's, which Scottish man was Commissioned by the East India Company to prepare reports on Education and progress in the native schools of Bengal and Bihar?

- Ans
- 1. Anthony Mc Donnel
  - 2. John Sargent
  - 3. William Adam
  - 4. Joseph Hartog

Q.7 Which word has been substituted for the words 'Unity of the Nation' in the 42nd Amendment Act of the Preamble of the Constitution of India?

- Ans
- 1. Unity and honesty of the nation
  - 2. Unity and equity of the nation
  - 3. Unity and integrity of the nation
  - 4. Unity and morality of the nation

Q.8 Based on which committee recommendations, RBI introduced a comprehensive regulatory framework for NBFC-MFIs?

- Ans
- 1. Gadgil committee
  - 2. Malegam committee
  - 3. Kelkar committee
  - 4. Rangarajan committee

Q.9 Which Minister led the Indian delegation in the meeting of the digital and technology ministers of G7 countries held in Japan on 29 and 30 April 2023?

- Ans
- 1. Ashwini Vaishnaw
  - 2. Ajay Bhatt
  - 3. Bhupendra Yadav
  - 4. Sarbananda Sonowal

Q.10 According to Census of India 2011, which state recorded negative population growth rate?

- Ans
- 1. Manipur
  - 2. Nagaland
  - 3. Sikkim
  - 4. Kerala

Q.11 When was the First Five-Year Plan of India launched?

- Ans
- 1. 1950
  - 2. 1951
  - 3. 1956
  - 4. 1961

Q.12 After realising the deadly effects of depleting the ozone layer, under which programme was the decision taken to ban the usage of CFC?

- Ans
- 1. United Nations Development Programme
  - 2. Natural State Environmental Programme
  - 3. United Nations Environment Programme
  - 4. Federal Energy Management Programme

Q.13 Who marked the historic moment by unveiling the 'Yashobhoomi' convention centre in Delhi in September 2023?

- Ans
- 1. Arvind Kejriwal
  - 2. Dharmendra Pradhan
  - 3. Narendra Modi
  - 4. Droupadi Murmu

Q.14 The Pala rulers achieved their domination in which province of India?

- Ans
- 1. Kashmir
  - 2. Orissa
  - 3. Assam
  - 4. Bengal

Q.15 What is the main content of the Fourth Schedule in the Constitution of India?

- Ans
- 1. Allocation of seats in the Council of States
  - 2. Allocation of seats in the Lok Sabha
  - 3. Directive Principles of State Policy
  - 4. Provisions for State Legislature

Q.16 Who along with Barry Marshall, was awarded the Nobel Prize in Physiology or Medicine in 2005 for discovering that stomach ulcer is an infectious disease caused by bacteria?

- Ans
- 1. Jean Paul Vuillemin
  - 2. Robert Koch
  - 3. Gabriel Pouchet
  - 4. Robin Warren

Q.17 In 2023, who among the following individuals served as the governor of Telangana?

- Ans
- 1. Ganesh Lal
  - 2. Tamilisai Soundararajan
  - 3. Kalraj Mishra
  - 4. Baby Rani Maurya

Q.18 Which of the following is NOT included while estimating National Income?

- I. Goods sold by street hawkers
- II. Services of housewives
- III. Production of vegetable in kitchen garden

- Ans
- 1. Only I and II
  - 2. Only III
  - 3. Only II and III
  - 4. All I, II and III

Q.19 Who composed the music for the film Kashmir ki Kali?

- Ans
- 1. Naushad
  - 2. Hemant Kumar
  - 3. OP Nayyar
  - 4. Salil Chowdhury



Q.20 The largest river system of Rajasthan is \_\_\_\_\_.

- Ans
- 1. Tapi
  - 2. Luni
  - 3. Bhima
  - 4. Kaveri

Q.21 When two nuclei fuse together forming one nucleus during cell fusion, it is known as:

- Ans
- 1. synkaryon
  - 2. eukaryon
  - 3. heterokaryon
  - 4. syncytium

Q.22 Which Nationalist Democratic Progressive Party (NDPP) leader was sworn in as the fifth Chief Minister of Nagaland in March 2023?

- Ans
- 1. Wanweiroy Kharlukhi
  - 2. Chingwang Konyak
  - 3. Tokheho Yephthomi
  - 4. Neiphiu Rio

Q.23 Before starting a 5 day and 5 night excursion, Mr. Patel provided all his students with battery powered flash lights. He also gave them some extra batteries to use as spare. Then Mr. Patel asked them whether they know how the batteries will produce electricity and help them. What do you think the correct answer to his question is?

- Ans
- 1. Electricity is produced by the chemicals stored in the battery
  - 2. Electricity is produced by friction between the battery and the flash light
  - 3. Electricity is saved in the battery from the factory that produces it
  - 4. Battery extracts electricity from the environment and passes it to the flash light

Q.24 In which of the following groups of the periodic table is the metallic element 'silver' found?

- Ans
- 1. Group 15
  - 2. Group 11
  - 3. Group 3
  - 4. Group 7

Q.25 According to Census 2011 of India, which of the following groups of union territories has the highest urban population?

- Ans
- 1. Chandigarh and Lakshadweep
  - 2. Daman & Diu and Lakshadweep
  - 3. Puducherry and Lakshadweep
  - 4. Puducherry and Chandigarh

Q.26 "Meri LiFE" (My life) app was launched in May 2023 by union minister Shri Bhupender Yadav. Which ministry does he belong?

- Ans
- 1. Ministry of Earth Sciences
  - 2. Ministry of Environment, Forest and Climate Change
  - 3. Ministry of Agriculture and Farmers Welfare
  - 4. Ministry of Health and Family Welfare

Q.27 On which date did the cantonment of Meerut break out in military mutiny during the 1857 movement?

- Ans
- 1. 09 April 1857
  - 2. 30 May 1857
  - 3. 10 May 1857
  - 4. 30 March 1857

Q.28 Who inspired Indians by raising the slogan 'Freedom is my birthright and I shall have it!'?

- Ans
- 1. Swami Vivekananda
  - 2. Sachindra Nath Sanyal
  - 3. Bhagat Singh
  - 4. Bal Gangadhar Tilak

Q.29 According to Article 58 of the Constitution of India, no person shall be eligible for election as President unless he is a citizen of India, has completed the age of \_\_\_\_ and is qualified for election as a member of the House of the People.

- Ans
- 1. 27 years
  - 2. 30 years
  - 3. 35 years
  - 4. 40 years

Q.30 What is the name of the compound with the formula  $N_2O_5$ ?

- Ans
- 1. Dinitrogen pentoxide
  - 2. Nitrogen dioxide
  - 3. Nitric oxide
  - 4. Nitrous oxide

Q.31 What does the CONCATENATE function do in Microsoft Excel?

- Ans
- 1. Combines text from multiple cells into one cell
  - 2. Splits text into separate cells
  - 3. Converts text to uppercase
  - 4. Finds the average of a range of cells

Q.32 Which species of sponges is commonly called glass sponge due to the presence of silica spicules?

- Ans
- 1. Euplectella
  - 2. Planaria
  - 3. Calcarea
  - 4. Spongilla

Q.33 What was the main objection against the Directive Principles of State Policy in the Constituent Assembly?

- Ans
- 1. They were an instrument of instructions
  - 2. They were non justiciable in character
  - 3. They were considered as novel features
  - 4. The state was responsible for these policies

Q.34 Which one of the following has the largest population in a food chain?

- Ans
- 1. Primary consumers
  - 2. Producers
  - 3. Decomposers
  - 4. Secondary consumers

Q.35 The process by which molecules from a region of higher concentration move to a region of lower concentration is known as:

- Ans
- 1. evaporation
  - 2. boiling
  - 3. diffusion
  - 4. melting

Q.36 Kala Ramnath is associated with which of the following gharanas?

- Ans
- 1. Mewati gharana
  - 2. Bhendibazaar gharana
  - 3. Agra gharana
  - 4. Indore gharana

Q.37 Which chemical compound is responsible for the spicy taste in chilli peppers?

- Ans
- 1. Capsaicin
  - 2. Caffeine
  - 3. Ethanol
  - 4. Tannin

Q.38 In the context of a Microsoft Excel sheet, what does the term 'workbook' mean?

- Ans
- 1. A single sheet within a file
  - 2. The entire Microsoft Excel file
  - 3. A formula used in calculations
  - 4. A chart or graph

Q.39 On cold pressing groundnut, oils are released. This indicates the presence of \_\_\_\_\_.

- Ans
- 1. Carbohydrates
  - 2. Fats
  - 3. Vitamins
  - 4. Proteins

Q.40 What is the height of the Kanchenjunga peak?

- Ans
- 1. 8958 m
  - 2. 8527 m
  - 3. 8859 m
  - 4. 8598 m

Q.41 Pascal is the SI unit of \_\_\_\_\_, which is defined as a force of 1 N applied uniformly over an area of 1 m<sup>2</sup>.

- Ans
- 1. mass density
  - 2. energy
  - 3. pressure
  - 4. power

Q.42 Who is the ultimate interpreter of the Constitution?

- Ans
- 1. Supreme Court
  - 2. District Courts
  - 3. President
  - 4. Speaker

Q.43 Which of the following is an example of formation of metamorphic rocks?

- Ans
- 1. Formation of Chalk
  - 2. Formation of Sandstone
  - 3. Formation of Limestone
  - 4. Formation of Slate

Q.44 The Registration of Births and Deaths (Amendment) Bill was introduced in the Lok Sabha by which ministry on 26 July 2023?

- Ans
- 1. Ministry of Home Affairs
  - 2. Ministry of Women and Child Development
  - 3. Ministry of Health and Family Welfare
  - 4. Ministry of Information and Broadcasting

Q.45 India defeated West Indies in which of the following World Cup finals?

- Ans
- 1. 1983 England
  - 2. 2007 West Indies
  - 3. 2019 England
  - 4. 2003 South Africa

Q.46 A village is established in a region where land meets the ocean. What is this region called?

- Ans
- 1. Coastal Region
  - 2. Marshy Land
  - 3. Tropical Region
  - 4. Sea Beach

Q.47 Which of the following sports events was NEVER hosted by India?

- Ans
- 1. Olympics
  - 2. Commonwealth Games
  - 3. ICC Men World Cup Cricket
  - 4. Asian Games

Q.48 Which of the following states has launched the 'Mo Ghara' or 'My Home' scheme, with an aim to transform kutcha houses into pucca ones?

- Ans
- 1. Chhattisgarh
  - 2. West Bengal
  - 3. Odisha
  - 4. Jharkhand

Q.49 Food digested in the stomach passes through the intestines so that the blood vessels can absorb essential nutrients for the functioning and growth of the body. What is this process known as?

- Ans
- 1. Transmission
  - 2. Assimilation
  - 3. Transfusion
  - 4. Integration

Q.50 A low pitched but louder sound has \_\_\_\_\_.

- Ans
- 1. lower frequency and higher amplitude
  - 2. higher frequency and lower amplitude
  - 3. lower frequency and lower amplitude
  - 4. higher frequency and higher amplitude

Section : General Engineering Electrical

Q.1 The magnetic flux through a coil having a single turn is varying according to the relation  $\phi = (5t^2 + 4t + 10)$  wb. Determine the impedance of the coil if the induced current through the coil is 5A at  $t = 2$  seconds.

- Ans
- 1. 4  $\Omega$
  - 2. 8.4  $\Omega$
  - 3. 4.8  $\Omega$
  - 4. 40  $\Omega$

Q.2 A capacitor of capacitive reactance 5 $\Omega$  is connected across a 220V, 50Hz supply. Calculate the maximum current drawn by the capacitor.

- Ans
- 1. 44 A
  - 2. 40 A
  - 3.  $44\sqrt{2}$  A
  - 4. 100 A

Q.3 In estimation and costing, the estimator must understand production cost, including labour and material cost of products, as well as discounts on purchases in order to:

- Ans
- 1. work out profit
  - 2. retain a list
  - 3. prepare schedules
  - 4. gain knowledge

Q.4 The maximum efficiency in the transmission of bulk AC power will be achieved when the power factor of the load is:

- Ans
- 1. considerably less than unity
  - 2. unity
  - 3. slightly less than unity lagging
  - 4. slightly less than unity leading

Q.5 In ring distribution scheme, \_\_\_\_\_ of a \_\_\_\_\_ transformer form a loop.

- Ans
- 1. secondaries, distribution
  - 2. primaries, power
  - 3. primaries, distribution
  - 4. secondaries, power

Q.6 In the context of electromagnetism, according to Fleming's left-hand rule, the thumb indicates the \_\_\_\_\_.

- Ans
- 1. direction of the motion of the conductor
  - 2. direction of the magnetic field
  - 3. direction of the current
  - 4. length of the conductor

Q.7 Which of the following statements is/are accurate regarding working principle of a reluctance start motor?

1. In reluctance, motor reluctance torque can occur once a ferromagnetic object is located within an exterior magnetic field, then the object can be line up through the external magnetic field.
2. The torque can be generated among the two fields which twirling the object in the region of the line through the magnetic field so the torque is used on the object to provide less reluctance for the magnetic flux.

- Ans
- 1. Only 2 is true
  - 2. Both 1 and 2 are true
  - 3. Both 1 and 2 are not true
  - 4. Only 1 is true

Q.8 Which of the following statements correctly explains the relation between the maximum demand and the connected load during a practical scenario in a power system?

- Ans
- 1. The maximum demand will always be equal to the connected load.
  - 2. The maximum demand will always be greater than the connected load.
  - 3. The maximum demand and the connected load do not exhibit any relation with each other.
  - 4. The maximum demand will always be less than the connected load.

Q.9 An external resistance is added in the motor circuit during starting condition. The main purpose of this is to \_\_\_\_\_.

- Ans
- 1. reduce the starting current
  - 2. reduce the main flux
  - 3. increase the main flux
  - 4. increase the starting current

Q.10 A three-phase star connected load draws 3600 VAR when the line voltage is 200 V and the line current is  $10\sqrt{3}$  A. The power factor is \_\_\_\_\_.

- Ans
- 1. 1
  - 2. zero
  - 3. 0.8
  - 4. 0.6

Q.11 For the three coupled coils shown below, the total inductance will be \_\_\_\_\_.

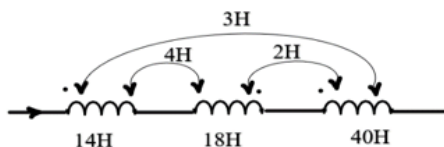

- Ans
- 1. 90 H
  - 2. 66 H
  - 3. 81 H
  - 4. 60 H

Q.12 If  $R_1 = 1 \Omega$ ;  $R_2 = 2 \Omega$ ;  $R_3 = 3 \Omega$ ;  $R_2$  and  $R_3$  are connected in parallel and the combination is in series with  $R_1$ , then the total resistance will be \_\_\_\_\_.

- Ans
- 1.  $2.8 \Omega$
  - 2.  $1.2 \Omega$
  - 3.  $2.2 \Omega$
  - 4.  $1.5 \Omega$

Q.13 What is the primary purpose of a back-to-back power electronic converter (PEC) in type-C doubly-fed induction generator wind power plants?

- Ans
- 1. To match stator and rotor frequencies
  - 2. To control reactive power production
  - 3. To regulate wind turbine speed
  - 4. To convert mechanical power to electrical power

Q.14 A 200-V, DC motor has an armature resistance of  $0.5 \Omega$ . It is drawing an armature current of 20 A driving a certain load. Calculate the induced EMF in the motor under this condition.

- Ans
- 1. 203.7 V
  - 2. 175.8 V
  - 3. 190 V
  - 4. 199.3 V

Q.15 Which of the following systems is NOT a part of the operating mechanism in a single-phase energy meter?

- Ans
- 1. Energy system
  - 2. Braking system
  - 3. Registering system
  - 4. Driving system

Q.16 Which is the formula for transmission line efficiency?

- Ans
- 1. Efficiency = received power + transmitted power  $\times 100$
  - 2. Efficiency = received power - transmitted power  $\times 100$
  - 3. Efficiency =  $\frac{\text{received power}}{\text{transmitted power}} \times 100$
  - 4. Efficiency =  $\frac{-\text{received power}}{\text{transmitted power}} \times 100$

Q.17 In electromagnetism, the work done on a unit n-pole in moving once around any complete path will be equal to the product of the current and the number of turns enclosed by that path is stated by \_\_\_\_\_.

- Ans
- 1. Work's law
  - 2. Lenz's law
  - 3. Laplace's law
  - 4. Coulomb's law

Q.18 What is the correct order of the following operations, performed for conducting the estimation?

- a) Wiring layout
- b) Calculation of the total number of connections
- c) Selection of the main switch board

- Ans
- 1. c, a, b
  - 2. a, c, b
  - 3. a, b, c
  - 4. b, c, a

Q.19 In a thermal power plant, the overall efficiency can be determined using which of the following?

- Ans
- 1. Regenerative Cycle Efficiency
  - 2. Rankine Cycle Efficiency
  - 3. Carnot Cycle Efficiency
  - 4. Boiler Efficiency × Generator Efficiency × Turbine Efficiency

Q.20 The torque developed by a 3-phase induction motor least depends on which the following options ?

- Ans
- 1. rotor EMF
  - 2. rotor current
  - 3. shaft diameter
  - 4. rotor power factor

Q.21 In the shaded-pole induction motor, the shading coil fitted on the \_\_\_\_\_ is called \_\_\_\_\_.

- Ans
- 1. auxiliary pole; shading pole
  - 2. main pole; shading pole
  - 3. auxiliary pole; non-shading pole
  - 4. main pole; non-shading pole

Q.22 Which of the following are the properties of a good heating element?

- I) It should have low resistivity.
- II) It should have high melting point.
- III) It should have low temperature coefficient of resistance.
- IV) It should have high specific heat capacity.

- Ans
- 1. II, III and IV
  - 2. I, II and IV
  - 3. Only II and III
  - 4. I, II and III

Q.23 Which of the following is correct with reference to step up single-phase transformer?

- Ans
- 1. Turn ratio ≠ Transformation ratio
  - 2. Turn ratio > Transformation ratio
  - 3. Turn ratio = Transformation ratio
  - 4. Turn ratio < Transformation ratio

Q.24 What type of boilers are suitable for low-maintenance cost, small size and low-pressure plants?

- Ans
- 1. Supercritical boilers
  - 2. Water tube boilers
  - 3. Fire tube boilers
  - 4. High-pressure boilers

Q.25  $I$ ,  $R$ ,  $X_L$ ,  $V_R$  and  $\cos\phi_R$  represent voltage regulation, line current, line resistance, line reactance, receiving end voltage and load power factor of transmission line, respectively. Also, receiving end voltage is more than the sending end voltage. Identify the correct expression for the leading load power factor.

- Ans
- 1.  $IR \cos\phi_R \gg IX_L \cos\phi_R$
  - 2.  $IR \cos\phi_R < IX_L \cos\phi_R$
  - 3.  $IR \cos\phi_R = IX_L \cos\phi_R$
  - 4.  $IR \cos\phi_R > IX_L \cos\phi_R$



Q.26 In electromagnetism, the magnetic field set up by a steady current density is described by \_\_\_\_\_.

- Ans
- 1. Lenz's law
  - 2. Laplace's law
  - 3. Faraday's law
  - 4. Ohm's law

Q.27 In a transistor of common base connection, the ratio of change in the output current to change in the input current at a constant collector-base voltage is called \_\_\_\_\_.

- Ans
- 1. current amplification factor
  - 2. input resistance factor
  - 3. base current amplification factor
  - 4. output resistance factor

Q.28 Which of the following is a criterion used for selecting the ratio of the minimum fault current to the maximum load current in over-current protection of a transmission line?

- Ans
- 1. To prevent the possibility of maloperation under normal operating conditions
  - 2. To reduce the maximum load current on the transmission line
  - 3. To decrease the sensitivity of the protection system to faults
  - 4. To increase the possibility of maloperation under normal operating conditions

Q.29 In an electrodynamic instrument, what happens to the torque when the current flowing through the coil is decreased?

- Ans
- 1. The torque increases.
  - 2. The torque remains constant.
  - 3. The torque becomes zero.
  - 4. The torque decreases.

Q.30 Mutual inductance between two magnetically coupled coils does NOT depend on which of the following?

- Ans
- 1. Cross sectional area of their common core
  - 2. Temperature of the coil
  - 3. Permeability of the core material
  - 4. Number of turns of the coils

Q.31 In electrical installation and costing, which of the following is NOT a scope of national electrical code?

- Ans
- 1. Standard good practices
  - 2. Distinguishing of fundamental components
  - 3. General safety procedure
  - 4. Recommendations concerning safety

Q.32 In case of commercial installations, it is advisable to use light sources rendering high colour for installations so as to retain customer attention. This light should be as bright as its surroundings in the range of \_\_\_\_\_.

- Ans
- 1. 2 times
  - 2. 5 times
  - 3. 10 times
  - 4. 20 times

Q.33 With respect to AC fundamentals of an electrical signal, the ratio of the area under the curve to the base is called \_\_\_\_\_.

- Ans
- 1. effective value
  - 2. RMS value
  - 3. average value
  - 4. peak value

Q.34 The deflecting torque in an electrostatic instrument can be calibrated by \_\_\_\_\_.

- Ans
- 1. adjusting the damping
  - 2. adjusting the spring constant
  - 3. adjusting the frequency
  - 4. adjusting the potential difference between the plates

Q.35 Which of the following statements is true about the voltage control of DC motors?

- Ans
- 1. The terminal voltage is kept constant and the field current is varied so as to obtain speed control.
  - 2. The application of this method is restricted to self-excited DC motors.
  - 3. The application of this method is restricted to separately excited DC motors.
  - 4. The field current is kept constant and the terminal voltage is varied to obtain speed control.

Q.36 A balanced, delta-connected load has an impedance of  $3\angle 30^\circ \Omega/\text{phase}$ . What will be the impedance of an equivalent star-connected load?

- Ans
- 1.  $3\angle 90^\circ \Omega/\text{phase}$
  - 2.  $1\angle 30^\circ \Omega/\text{phase}$
  - 3.  $4\angle 30^\circ \Omega/\text{phase}$
  - 4.  $2\angle 60^\circ \Omega/\text{phase}$

Q.37 What happens to the reading of a wattmeter when the power factor of a circuit is changed from unity power factor to leading power factor?

- Ans
- 1. The wattmeter reading increases
  - 2. The wattmeter reading remains unchanged
  - 3. The wattmeter reading decreases
  - 4. The wattmeter cannot measure the leading power factor

Q.38 Slip is 1 when rotor is \_\_\_\_\_.

- Ans
- 1. rotating with synchronous speed
  - 2. stationary
  - 3. rotating at a speed lower than synchronous speed
  - 4. rotating at a speed higher than synchronous speed

Q.39 The Fermi level position \_\_\_\_\_ in the energy band diagram of a p-n junction at equilibrium states.

- Ans
- 1. does not exist
  - 2. is uphill for electrons to cross the junction
  - 3. is constant for electrons to cross the junction
  - 4. is downhill for electrons to cross the junction

Q.40 The Variation in the effective width of a base in a Bipolar Junction Transistor is due to a variation in the applied \_\_\_\_\_.

- Ans
- 1. emitter to collector voltage
  - 2. collector current
  - 3. emitter current
  - 4. base to collector voltage

Q.41 Which of the following statements are correct about the errors in PMMC instruments?

- I. The swamping resistance is included in series with the moving coil to reduce errors.
- II. The swamping resistance is included in parallel with the moving coil to reduce errors.
- III. Errors are caused by weakening of the permanent magnet due to aging.
- IV. Errors are caused by weakening of the spring due to aging and temperature.

- Ans
- 1. Only II, III and IV
  - 2. Only I, III and IV
  - 3. Only III and IV
  - 4. Only I and III

Q.42 Which of the following statements is FALSE in the context of the characteristics of synchronous motors?

- Ans
- 1. They have constant speed operation.
  - 2. They are made in large sizes.
  - 3. Synchronous motors have high power factor correction.
  - 4. They have low operating efficiency.

Q.43 A 6-pole, 250 V wave connected shunt motor running at 955 rpm has 1200 armature conductors and useful flux/pole of 10m Wb. The armature and field resistance are 0.5  $\Omega$  and 250  $\Omega$ , respectively. If the motor draws 20 A from the supply mains, then the value of torque developed by the motor is \_\_\_\_\_.

- Ans
- 1. 57.9 N-m
  - 2. 62.3 N-m
  - 3. 45.6 N-m
  - 4. 65.8 N-m

Q.44 What is the armature-circuit-resistance speed control method for DC motor?

- Ans
- 1. Variation of field flux
  - 2. Variation of resistance in the armature circuit
  - 3. Variation of resistance in the field circuit
  - 4. Variation of armature terminal voltage

Q.45 A light source with a candle worth of power produces \_\_\_\_\_.

- Ans
- 1. one lumen / watt
  - 2. one lumen / meter
  - 3. one lumen / radian
  - 4. one lumen / steradian

Q.46 The wattmeter method is used to measure power in a three-phase load. The wattmeter readings are 200 W and -35 W. Find the respective values of active power and reactive power.

- Ans
- 1. 235 W and  $50\sqrt{3}$  VAR
  - 2. 165 W and  $\frac{50}{\sqrt{3}}$  VAR
  - 3. 165 W and  $235\sqrt{3}$  VAR
  - 4. 235 W and  $\frac{150}{\sqrt{3}}$  VAR

Q.47 The sum of instantaneous powers in the three phases in a three-phase system:

- Ans
- 1. is zero
  - 2. thrice the line frequency
  - 3. twice the line frequency
  - 4. remains constant

Q.48 A signal applied to a CRO has a rising time of 0.5  $\mu$  s. Its bandwidth is:

- Ans
- 1. 0.05 MHz
  - 2. 0.2 MHz
  - 3. 0.07 MHz
  - 4. 0.7 MHz

Q.49 Which of the following is correct for a step down single-phase transformer?

- Ans
- 1. Input volt ampere < output volt ampere
  - 2. Input volt ampere  $\neq$  output volt ampere
  - 3. Input volt ampere = output volt ampere
  - 4. Input volt ampere > output volt ampere

Q.50 Which of the following effects is predominant when a dielectric material is polarised?

- Ans
- 1. It makes charged particles free to move and causes current to flow in the material.
  - 2. Charged particles re-orientate themselves in the out phase with the electric field.
  - 3. It causes current to flow in the material.
  - 4. It makes charged particles free to move.

Q.51 An ideal BJT acts as an open switch when:

- Ans
- 1.  $V_{CE} = V_{CC}$  and  $I_c = 0$
  - 2.  $V_{BE} = V_{CC}$  and  $I_B = 50 \mu\text{A}$
  - 3.  $V_{CE} = V_{BC}$  and  $I_c = 10 \text{ mA}$
  - 4.  $V_{CE} = 0$  and  $I_c = 10 \text{ mA}$

Q.52 1 ampere of current is equal to how many number of electrons?

- Ans
- 1.  $4.25 \times 10^{18}$
  - 2.  $6.25 \times 10^{-18}$
  - 3.  $4.25 \times 10^{-18}$
  - 4.  $6.25 \times 10^{18}$

Q.53 How much energy in “kilowatt hours” is consumed in operating ten 100-watt bulbs for 20 hours per day in a month (30 days)?

- Ans
- 1. 5000 kilowatt-hours
  - 2. 10000 kilowatt-hours
  - 3. 600000 kilowatt-hours
  - 4. 600 kilowatt-hours

Q.54 A series R-L-C circuit having  $R = 5 \Omega$ ,  $L = 400 \text{ H}$  and  $C = 4\text{F}$  is fed from a  $400 \angle 0^\circ$  volt supply. Then the voltage across the capacitor at resonance will be \_\_\_\_\_.

- Ans
- 1. 800 V
  - 2. 400 V
  - 3. 200 V
  - 4. 1000 V

Q.55 Calculate the reading that will be given by a hot-wire voltmeter when it is connected across the terminals of a generator whose voltage is given by  $V(t) = (2 \sin wt + 3 \sin 3 wt + 5 \sin 5 wt)$  Volt.

- Ans
- 1. 0 volt
  - 2. 10 volts
  - 3.  $\sqrt{19}$  volts
  - 4.  $\sqrt{38}$  volts

Q.56 What is the correction factor of the wattmeter at a lagging power factor?

(Where,  $\phi$  is the phase angle between the voltage applied to the pressure coil and the current in the current coil and  $\beta$  is the angle between the voltage applied to the pressure coil and the current in the pressure coil.)

- Ans
- 1.  $\frac{\cos \Phi}{\cos \beta \sin(\Phi - \beta)}$
  - 2.  $\frac{\cos \Phi}{\cos \beta \cos(\Phi - \beta)}$
  - 3.  $\frac{\cos \Phi}{\cos \beta \cos(\Phi + \beta)}$
  - 4.  $\frac{\cos \Phi}{\cos \beta \sin(\Phi + \beta)}$

Q.57 A conductor of length 5 m moves at an angle  $30^\circ$  to the direction of the magnetic field of flux density  $1.4 \text{ wb/m}^2$ . If the velocity of the conductor is 40 m/s, then calculate the EMF induced in it.

- Ans
- 1. 100 volts
  - 2. 1400 volts
  - 3. 140 volts
  - 4. 0 volt

Q.58 In resistors, if the temperature is increased, then the resistance of alloys will \_\_\_\_\_.

- Ans
- 1. decrease
  - 2. remain the same
  - 3. become zero
  - 4. increase

Q.59 Which of the following lamps is NOT a discharge lamp?

- Ans
- 1. Neon lamp
  - 2. Sodium vapour lamp
  - 3. Mercury vapour Lamp
  - 4. Incandescent lamp

Q.60 A 400 V, 3-phase synchronous motor has armature current of 150 A. It has synchronous resistance and reactance of  $0.4 \Omega$  and  $4 \Omega$  per phase, respectively. If the power developed is 130 kW and the iron and friction losses are 1 kW, then the efficiency of the motor will be \_\_\_\_\_.

- Ans
- 1. 75%
  - 2. 91.6%
  - 3. 81.6%
  - 4. 60%

Q.61 Which of the following is NOT broadly classified as a part of agrochemicals?

- Ans
- 1. Digesicides
  - 2. Fungicides
  - 3. Herbicides
  - 4. Insecticides

Q.62 The plant capacity factor is related to \_\_\_\_\_.

- Ans
- 1. plant operating frequency
  - 2. plant resistance
  - 3. plant reactance
  - 4. plant impedance

Q.63 Which of the following is a pure resistive device?

- Ans
- 1. Transformer
  - 2. Motor
  - 3. Generator
  - 4. Heater

Q.64 As per the general principles of estimating, whenever practicable, it is advantageous to execute the work only after \_\_\_\_\_.

- Ans
- 1. tenders are invited
  - 2. payments of bills are made
  - 3. purchase orders are placed
  - 4. tenders are evaluated

Q.65 Ten capacitors, each of capacitance  $20 \mu\text{F}$ , are first connected in series and then in parallel. The ratio of the equivalent capacitance in series to the equivalent capacitance in parallel is:

- Ans
- 1.  $1/200$
  - 2.  $1/100$
  - 3.  $1/400$
  - 4.  $1/250$

Q.66 Total Reactive Power drawn from a three-phase balanced load where line voltage =  $V_P$ , Line current =  $I_L$ , Phase voltage =  $V_P$  and Phase current =  $I_P$  is given by:

- Ans
- 1.  $\sqrt{3} V_L I_L \cos\phi$
  - 2.  $\sqrt{3} V_P I_P \sin\phi$
  - 3.  $3 V_P I_P \cos\phi$
  - 4.  $\sqrt{3} V_L I_L \sin\phi$

Q.67 In the context of magnetic circuits, the value of the leakage coefficient for electrical machines is usually about \_\_\_\_\_.

- Ans
- 1. 1.25 to 1.5
  - 2. 1.15 to 1.25
  - 3. 1.5 to 1.75
  - 4. 0.5 to 1

Q.68 Which of the following statements are true regarding the DC load line?

- a) It is a straight line drawn between  $I_C$  and  $V_{CE}$ .
- b) The quiescent point lies on the load line.
- c) In the DC load line, when the collector emitter voltage  $V_{CE} = 0$ , the collector current is maximum.

- Ans
- 1. Only a and c
  - 2. All of a, b and c
  - 3. Only a and b
  - 4. Only b and c

Q.69 For a D-MOSFET when biased at  $V_{GS} = 0$  V having  $I_{DSS} = 30$  mA and  $V_{GS}(\text{off}) = -6$  V, the drain current is equal to \_\_\_\_\_.

- Ans
- 1. 0 mA
  - 2. infinite
  - 3. 30 mA
  - 4. 20 mA

Q.70 At steady-state characteristics of a DC series motor, which of the following statements are correct?

- I) The speed-torque relationship of a DC series motor is non-linear.
- II) Both the armature current and the field current of a DC series motor decrease with increasing load torque.
- III) The efficiency of a DC series motor is generally higher compared to DC shunt motor.
- IV) The efficiency of a DC series motor is generally lower compared to DC shunt motor.

- Ans
- 1. Statements I, II and III correct
  - 2. Only statements I and IV are correct
  - 3. Only statements I and III are correct
  - 4. Statements I, II and IV are correct

Q.71 The ratio of the mean spherical candle power to the mean horizontal candle power is called \_\_\_\_\_.

- Ans
- 1. reduction factor
  - 2. lamp efficiency
  - 3. utilization factor
  - 4. beam factor

Q.72 Which crop is primarily used to produce biomass alcohol fuel or ethanol in India?

- Ans
- 1. Rice
  - 2. Corn
  - 3. Sugarcane
  - 4. Wheat

Q.73 In an inductor, if the coil is wound on an insulating bobbin, without any magnetic material as core, then the inductor is called \_\_\_\_\_.

- Ans
- 1. variable inductor
  - 2. air-cored inductor
  - 3. ferrite-cored inductor
  - 4. iron-cored inductor

Q.74 Consider the following statements about equivalent circuit with core losses of single-phase motor and select the correct option.

1. Slip at maximum torque is calculated with the help of maximum power transfer theorem.

2. Torque of an induction motor  $T = \frac{W}{P}$ , where  $W$  = speed in rad/sec,  $P$  = Power.

- Ans
- 1. Only 1 is true
  - 2. Only 2 is true
  - 3. Both 1 and 2 are not true
  - 4. Both 1 and 2 are true

Q.75 The efficiency of a transmission line is \_\_\_\_\_.

- Ans
- 1. decreased with increase in load p.f.
  - 2. independent of load p.f.
  - 3. increased with increase in load p.f.
  - 4. increased with decrease in load p.f.

Q.76 An uneven air gap in the stator and the rotor of a squirrel cage induction motor will lead to \_\_\_\_\_ during operation.

- Ans
- 1. increased vibrations
  - 2. increased current
  - 3. increased torque
  - 4. increased speed

Q.77 A voltage source of  $V(t) = (10t^3 - 5t + 10)$  Volt is applied across a 10F capacitor, the current through the capacitor at  $t = 2$  sec is \_\_\_\_\_.

- Ans
- 1. 1150 A
  - 2. 1100 A
  - 3. 1000 A
  - 4. 1160 A



Q.78 Which of the following statements are correct about DC welding machines-MG Set?

- I) It uses non-coated type electrodes; hence the cost of electrode is cheap.
- II) It uses coated type electrodes; hence the electrode is expensive.
- III) It is best suited for welding thinner sheets (6 mm).
- IV) The initial cost of the machine is less compared to AC welding machine.

- Ans
- 1. I and IV
  - 2. II and III
  - 3. II and IV
  - 4. I and III

Q.79 A certain length of wire has its resistance measured as  $20\ \Omega$  at  $20^\circ\text{C}$  and  $40\ \Omega$  at  $60^\circ\text{C}$ . Calculate the temperature coefficient.

- Ans
- 1.  $\left(\frac{1}{60}\right) / ^\circ\text{C}$
  - 2.  $30^\circ\text{C}$
  - 3.  $\left(\frac{1}{30}\right) / ^\circ\text{C}$
  - 4.  $\left(\frac{1}{40}\right) / ^\circ\text{C}$

Q.80 In an induction motor if the rotor is locked, then the rotor frequency of the induction motor will be:

- Ans
- 1. zero
  - 2. equal to supply frequency
  - 3. more than supply frequency
  - 4. less than supply frequency

Q.81 If the power factor of 500 KVA, 21 KW, 3-phase star connected alternator is increased from its initial value, then the efficiency of the synchronous generator will \_\_\_\_\_.

- Ans
- 1. remain constant
  - 2. increase
  - 3. become zero
  - 4. decrease

Q.82 A Thevenin equivalent source comprises of which of the following elements?

- Ans
- 1. A single current source in series with a resistance
  - 2. A single voltage source in parallel with a resistance
  - 3. A single voltage source in series with a resistance
  - 4. A single current source in parallel with a resistance

Q.83 At light load power factor of induction motors is \_\_\_\_\_.

- Ans
- 1. 1
  - 2. 0.2 to 0.4
  - 3. 0.8 to 0.9
  - 4. 0

Q.84 Which of the following is/are true regarding the significance of the 'barrier' in the rotor of a synchronous reluctance motor?

1. It prevents the rotor from rotating at synchronous speed.
2. It helps to reduce eddy current losses in the rotor.
3. It increases the magnetic flux density in the rotor.
4. It improves the torque characteristics of the motor.

Ans  1. Only 2  
 2. Both 2 and 4  
 3. Only 1 and 4  
 4. Both 1 and 3

Q.85 A DC source of EMF  $E$  volts and internal resistance  $R$  ohms is connected to a variable load and it is adjusted such that the load absorbs maximum power from the source. The maximum power delivered from the source to the load is:

Ans  1.  $\frac{E^2}{4R}$   
 2.  $\frac{2E^2}{R}$   
 3.  $\frac{E^2}{R}$   
 4.  $\frac{E^2}{2R}$

Q.86 In an unbiased pnp transistor, the barrier voltages are \_\_\_\_\_ on the base and \_\_\_\_\_ on the emitter and collector.

Ans  1. negative; positive  
 2. positive; positive  
 3. positive; negative  
 4. negative; negative

Q.87 Which of the following statements are correct?  
(a) Lenz's law is based on the conservation of charge.  
(b) Lenz's law gives the direction of induced current.  
(c) Lenz's law is based on the conservation of energy.

Ans  1. Both (a) and (b)  
 2. Both (a) and (c)  
 3. (a), (b) and (c)  
 4. Both (b) and (c)

Q.88 In radial distribution system, the consumers are dependent on \_\_\_\_\_ and \_\_\_\_\_.

Ans  1. multiple feeder, multiple distributor  
 2. multiple feeder, single distributor  
 3. single feeder, multiple distributor  
 4. single feeder, single distributor

Q.89 Which of the following photometric quantities measures the total amount of visible light emitted by a source in all directions?

Ans  1. Luminous intensity  
 2. Luminous flux  
 3. Illuminance  
 4. Luminance

Q.90 The hysteresis torque during the working of hysteresis motor depends on which factor?

- Ans
- 1. Stator flux only
  - 2. Rotor flux only
  - 3. Stator and rotor flux only
  - 4. Stator flux, rotor flux and sine of hysteresis angle

Q.91 Cold reserve is the reserve capacity of the plant in \_\_\_\_\_ but NOT in \_\_\_\_\_.

- Ans
- 1. operation, operation
  - 2. service, operation
  - 3. service, service
  - 4. operation, service

Q.92 The current reverser in the earth tester converts \_\_\_\_\_.

- Ans
- 1. DC to AC
  - 2. AC to AC
  - 3. DC to DC
  - 4. AC to DC

Q.93 Eight capacitors of the same value are connected in series. Their equivalent capacitance is  $200\mu\text{F}$ , the capacitance of each capacitor is \_\_\_\_\_.

- Ans
- 1.  $160\mu\text{F}$
  - 2.  $25\mu\text{F}$
  - 3.  $16\mu\text{F}$
  - 4.  $16 \times 10^4\text{ F}$

Q.94 What is the reactive power of a 3-phase, delta-connected system with line voltage of 100 V and line current of 40 A if the phase difference between the voltage and the current is  $36.87^\circ$ ?

- Ans
- 1. 4.155 kVAR
  - 2. 8.155 kVAR
  - 3. 6.155 kVAR
  - 4. 2.155 kVAR

Q.95 In nominal pi method, the line to neutral capacitance is:

- Ans
- 1. assumed lumped at the receiving end
  - 2. assumed lumped at the sending end
  - 3. assumed lumped at the midpoint
  - 4. divided into two halves

Q.96 What is Cold Reserve Capacity in a power system?

- Ans
- 1. The power generating capacity that is unavailable due to maintenance or other reasons.
  - 2. The power generating capacity that is permanently shut down.
  - 3. The power generating capacity that is readily available and online, ready to be dispatched.
  - 4. The power generating capacity that is not currently in use but can be brought online when needed.

Q.97 With the increase in voltage level of the distribution network, the weight and corresponding cost of the conductor material will be \_\_\_\_\_ and \_\_\_\_\_, respectively, for the same voltage drop.

- Ans
- 1. decreased; decreased
  - 2. decreased; increased
  - 3. increased; increased
  - 4. increased; decreased

Q.98 If the station has a thermal efficiency of 30% and electrical efficiency of 95%, find the overall efficiency of the station.

- Ans
- 1. 28.5%
  - 2. 26.5%
  - 3. 27.5%
  - 4. 29.5%

Q.99 In the context of electronic components, if a number of resistances are connected and the reciprocal of the sum of individual resistances is equal to the sum of reciprocals of individual resistances, then the type of connection is called \_\_\_\_\_.

- Ans
- 1. series-parallel circuit
  - 2. parallel circuit
  - 3. grouping circuit
  - 4. series circuit

Q.100 Which of the following statements is NOT true about DC signal?

- Ans
- 1. Pure Direct Current always has a constant value.
  - 2. A DC voltage is always negative or always positive.
  - 3. Cell, batteries and regulated power supplies provide a steady DC that is ideal for an electronic circuit.
  - 4. A DC voltage has both positive and negative values with change in time.

Adda247

## Junior Engineer Civil Mechanical and Electrical Examination 2024 Paper I

Exam Date	05/06/2024
Exam Time	1:00 PM - 3:00 PM
Subject	Junior Engineer 2024 Mechanical Paper I

### Section : General Intelligence and Reasoning

**Q1** Select the word-pair that best represents a similar relationship to the one expressed in the pair of words given below.  
(The words must be considered as meaningful English words and must not be related to each other based on the number of letters/number of consonants/vowels in the word.)

**Mycology : Fungi**

- Ans
- 1. Ornithology : Eggs
  - 2. Entomology : Birds
  - 3. Seismology : Earthquakes
  - 4. Paedology : Planets

**Q2** What should come in place of the question mark (?) in the given series based on the English alphabetical order?  
DMY, BKW, ZIU, XGS, ?

- Ans
- 1. UDP
  - 2. WCR
  - 3. UFR
  - 4. VEQ

**Q3** What should come in place of the question mark (?) in the given series based on the English alphabetical order?

MAT MET MIT MOT ?

- Ans
- 1. MXT
  - 2. MNT
  - 3. MUT
  - 4. MVT

**Q4** In a certain code language,  
A + B means 'A is the sister of B'  
A # B means 'A is the brother of B'  
A × B means 'A is the wife of B'  
A @ B means 'A is the father of B'  
Based on the above, how is E related to M if 'E # F × H @ G + M'?

- Ans
- 1. Mother's brother
  - 2. Father
  - 3. Brother
  - 4. Mother's father

**Q5** What should come in place of '?' in the given series?  
394, 465, 536, 607, 678, ?

- Ans
- 1. 749
  - 2. 768
  - 3. 756
  - 4. 736

Q6 This question consists of a pair of words which have a certain relationship to each other. Select the pair which has the same relationship.

(The words must be considered as meaningful English words and must not be related to each other based on the number of letters/number of consonants/vowels in the word.)

Altimeter : Altitudes

- Ans
- 1. Protractor : Light
  - 2. Fathometer : Pressure
  - 3. Taseometer : Wind
  - 4. Hygrometer : Humidity

Q7 The position(s) of how many letters will remain unchanged if each of the letters in the word STAMPED is arranged in the English alphabetical order?

- Ans
- 1. Two
  - 2. Three
  - 3. Four
  - 4. One

Q8 Select the option figure that can replace the question mark (?) in the figure given below to complete the pattern.

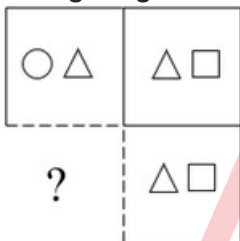

- Ans
- 1. △□
  - 2. □△
  - 3. ○△
  - 4. △○

Q.9 What will come in the place of the question mark (?) in the following equation, if '+' and '÷' are interchanged and 'x' and '-' are interchanged?

$$10 + 2 - 10 \div 5 \times 10 = ?$$

- Ans
- 1. 32
  - 2. 35
  - 3. 40
  - 4. 45

Q.10 IMPU is related to LPSX in a certain way based on the English alphabetical order. In the same way, BEKN is related to EHNQ. To which of the following is CLQS related, following the same logic?

- Ans
- 1. PLNF
  - 2. IJSH
  - 3. ACLK
  - 4. FOTV

Q.11 What will come in the place of the question mark (?) in the following equation, if '+' and 'x' are interchanged and '-' and '÷' are interchanged?

$$12 + 4 - 24 \times 11 \div 13 = ?$$

- Ans
- 1. 10
  - 2. -20
  - 3. -10
  - 4. 0

Q.12 In a certain code language, 'HAIR' is coded as '7935' and 'AGED' is coded as '4892'. What is the code for 'A' in the given language?

- Ans
- 1. 3
  - 2. 9
  - 3. 4
  - 4. 5

Q.13 What should come in place of the question mark (?) in the given series.

$$6, 3, 12, 6, 24, ?, 48, 24, 96$$

- Ans
- 1. 24
  - 2. 6
  - 3. 48
  - 4. 12

Q.14 In a certain code language,  
'A + B' means 'A is the brother of B',  
'A - B' means 'A is the mother of B',  
'A x B' means 'A is the wife of B' and  
'A ÷ B' means 'A is the father of B'.  
How is B related to L if 'B x G ÷ T + K - L'?

- Ans
- 1. Mother's mother
  - 2. Father's father
  - 3. Sister's daughter
  - 4. Brother's daughter

Q.15 Read the given statements and conclusions carefully. Assuming that the information given in the statements is true, even if it appears to be at variance with commonly known facts, decide which of the given conclusion(s) logically follow(s) from the statements.

Statements: Some cars are grass. All trucks are cars.

Conclusion 1: Some trucks are not cars.

Conclusion 2: Some trucks are grass.

- Ans
- 1. Only conclusion 2 follows
  - 2. Neither conclusion 1 nor 2 follows
  - 3. Both conclusion 1 and 2 follow
  - 4. Only conclusion 1 follows

Q.16 How many triangles are there in the given figure?

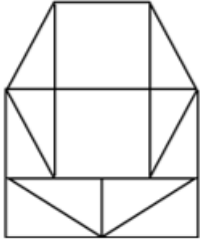

- Ans
- 1. 12
  - 2. 14
  - 3. 13
  - 4. 11

Q.17 142 is related to 92 following a certain logic. Following the same logic, 255 is related to 205. To which of the following is 457 related following the same logic?

(NOTE: Operations should be performed on the whole numbers, without breaking down the numbers into its constituent digits. E.g. 13 – Operations on 13 such as adding /subtracting /multiplying etc. to 13 can be performed. Breaking down 13 into 1 and 3 and then performing mathematical operations on 1 and 3 is not allowed.)

- Ans
- 1. 407
  - 2. 417
  - 3. 427
  - 4. 437

Q.18 OB 8 is related to UE 3 in a certain way. In the same way, TO 11 is related to ZR 6. To which of the following is IB 8 related, following the same logic?

- Ans
- 1. PE 3
  - 2. OE 3
  - 3. OF 3
  - 4. PF -3

Q.19 Select the correct option that indicates the arrangement of the following planets according to their size.

1. Mars
2. Jupiter
3. Venus
4. Earth
5. Mercury

- Ans
- 1. 5, 1, 3, 4, 2
  - 2. 5, 3, 4, 2, 1
  - 3. 5, 4, 2, 1, 3
  - 4. 5, 2, 1, 3, 4



Q.20 A, B, C, D, E, and F are sitting at a circular table facing the centre (not necessarily in the same order). A is to the immediate left of B, E is third to the right of B, D is to the immediate right of C. F is third to the right of C.

Who are the immediate neighbours of E?

- a) A and B
- b) B and D
- c) D and F
- d) F and B

Ans  1. (a)  
 2. (d)  
 3. (c)  
 4. (b)

Q.21 A, B, C, D, E and F are sitting around a circular table facing the centre (not necessarily in the same order). B is sitting to the immediate right of F and immediate left of C. C is sitting to the immediate left of E. A is sitting to the immediate right of E and to the immediate left of D. Who is sitting to the immediate left of F?

Ans  1. D  
 2. B  
 3. C  
 4. A

Q.22 Select the correct mirror image of the given figure when the mirror is placed at MN as shown below.

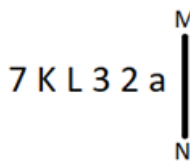

Ans  1. 5 9 ε 7 K L  
 2. e 5 L 3 K 7  
 3. 6 5 ε J K 7  
 4. 2 a ε J K 7

Q.23 What should come in place of the question mark (?) in the given series based on the English alphabetical order?  
INJ, LQM, OTP, RWS, ?

Ans  1. VUZ  
 2. VZU  
 3. UZV  
 4. UVZ

Q.24 Select the set in which the numbers are related in the same way as are the numbers of the following sets.  
(NOTE: Operations should be performed on the whole numbers, without breaking down the numbers into its constituent digits. E.g. 13 – Operations on 13 such as adding/subtracting/multiplying etc. to 13 can be performed. Breaking down 13 into 1 and 3 and then performing mathematical operations on 1 and 3 is not allowed.)  
(45, 23, 73)  
(19, 27, 51)

Ans  1. (31, 17, 48)  
 2. (12, 19, 30)  
 3. (22, 29, 52)  
 4. (16, 14, 35)

Q.25 15 is related to 230 following a certain logic. Following the same logic, 4 is related to 65. To which of the following is 12 related following the same logic?  
 (NOTE: Operations should be performed on the whole numbers, without breaking down the numbers into their constituent digits. E.g. 13 – Operations on 13 such as adding / subtracting /multiplying to 13 can be performed. Breaking down 13 into 1 and 3 and then performing mathematical operations on 1 and 3 is not allowed.)

- Ans
- 1. 187
  - 2. 186
  - 3. 185
  - 4. 180

Q.26 Select the option figure in which the given figure is embedded as its part (rotation is NOT allowed).

Ans

1.

2.

3.

4.

Q.27 What should come in place of the question mark (?) in the given series based on the English alphabetical order  
 KMO, HJL, EGI, BDF, ?

- Ans
- 1. YAC
  - 2. ZAC
  - 3. YBC
  - 4. ZBC

Q.28 Select the option in which the given figure is embedded (rotation is NOT allowed).



Ans

1.

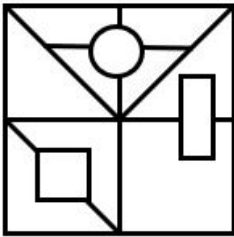

✗

2.

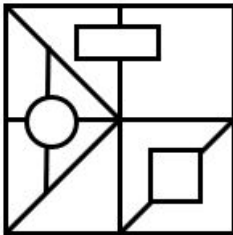

✓

3.

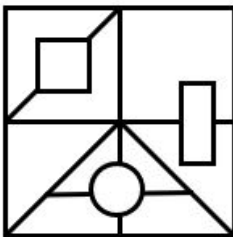

✗

4.

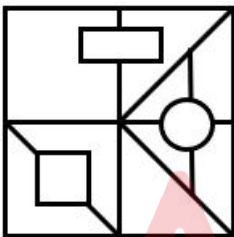

✗

Q.29 What should come in place of the question mark (?) in the given series based on the English alphabetical order?  
RQO, LKI, FEC, ZYW, TSQ, ?

Ans

✗ 1. NML

✗ 2. MNK

✓ 3. NMK

✗ 4. MNL

Q.30 Madan starts from point A and drives 4 km towards the South. He then takes a left turn and drives 5 km. he then takes a right turn and drives 2 km. He then takes another right turn and drives 3 km. He takes a final right turn and drives 6 km to reach point B. How far (shortest distance) and towards which direction should he drive to reach Point A again? (All turns are 90 degrees turns only unless specified)

Ans

✓ 1. 2 km West

✗ 2. 2 km East

✗ 3. 3 km West

✗ 4. 3 km East

Q.31 Select the correct mirror image of the given figure when the mirror is placed at MN as shown below.



- Ans
- 1. F 4 ¥ X R
  - 2. R X ¥ 4 F
  - 3. F 4 ¥ X R
  - 4. F 4 ¥ X R

Q.32 What will come in place of the question mark (?) in the following equation if '+' and '÷' are interchanged and 'x' and '-' are interchanged?

$$21 \div 15 \times 52 + 13 - 7 = ?$$

- Ans
- 1. 8
  - 2. 7
  - 3. 12
  - 4. 10

Q.33 What should come in place of the question mark (?) in the given series?

2, 5, 13, 28, 52, 87, ?

- Ans
- 1. 130
  - 2. 107
  - 3. 135
  - 4. 98

Q.34 Jennifer starts from Point D and drives 3 km towards the north. She then takes a left turn and drives 10 km. She then takes another left turn and drives 6 km. She takes one more left turn and drives 5 km. She then takes a right turn and drives 3 km. She takes a final left turn and drives 5 km to reach point E. How far (shortest distance) and towards which direction should she drive in order to reach Point D again? (All turns are 90 degree turns only, unless specified)

- Ans
- 1. 5 km East
  - 2. 6 km North
  - 3. 5 km North
  - 4. 3 km North

Q.35 Select the figure from the options that can replace the question mark (?) and complete the given pattern.

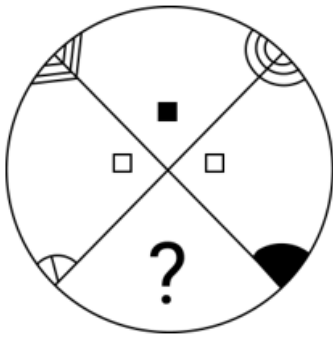

Ans

1.

✗

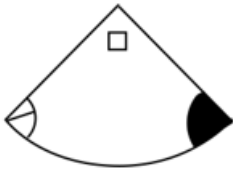

2.

✓

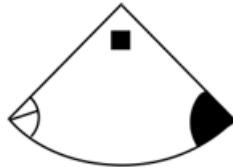

3.

✗

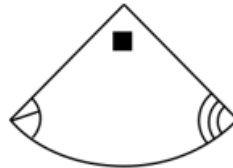

4.

✗



Q.36 Six friends Abby, Bunny, Chan, Dolly, Emma and Fanny have different weights. Dolly's weight is an odd number. Dolly is heavier than Emma but not the heaviest. Chan is heavier than Fanny but lighter than Dolly. Chan is not heavier than Emma but is heavier than Fanny and Abby. Abby's weight is not an odd number. The lightest weight is 45 kilograms and the heaviest weight is 80 kilograms.

Who is the heaviest person in the group?

Ans

✗ 1. Chan

✓ 2. Bunny

✗ 3. Emma

✗ 4. Abby

Q.37 LQNR is related to PURV in a certain way based on the English alphabetical order. In the same way, OTQU is related to SXUY. To which of the following is GLIM related, following the same logic?

- Ans
- 1. PKMQ
  - 2. KPMQ
  - 3. PQMK
  - 4. QPMK

Q.38 The position(s) of how many letters will remain unchanged if each of the letters in the word FOREIGN is arranged in the English alphabetical order?

- Ans
- 1. None
  - 2. One
  - 3. Two
  - 4. Three

Q.39 LQKN is related to PUOR in a certain way based on the English alphabetical order. In the same way, INHK is related to MRLO. To which of the following is QVPS related, following the same logic?

- Ans
- 1. WZTU
  - 2. WZUT
  - 3. UZTW
  - 4. UZWT

Q.40 What should come in place of the question mark (?) in the given series based on the English alphabetical order?  
LXC, OZD, RBE, UDF, ?

- Ans
- 1. XFG
  - 2. YGH
  - 3. ZDI
  - 4. XHJ

Q.41 In a certain code language, 'apple is healthy' is written as 'di jl ew' and 'apple is red' is written as 'di ko ew'. How is 'red' written in the given language?

- Ans
- 1. ko
  - 2. jl
  - 3. ew
  - 4. di

Q.42 STAR is related to TWCV in a certain way based on the English alphabetical order. In the same way, PARK is related to QDTO. To which of the following is MILK related, following the same logic?

- Ans
- 1. MLMO
  - 2. NLMO
  - 3. NLNO
  - 4. MLNO

Q.43 Select the option in which the numbers share the same relationship as that shared by the given number triads.

120-100-60  
240-220-180

(NOTE: Operations should be performed on the whole number, without breaking down the numbers into its constituent digits. E.g. 13- Operations on 13 such as adding/subtracting/multiplying etc. to 13 can be performed. Breaking down 13 into 1 and 3 and then performing mathematical operations on 1 and 3 is NOT allowed.)

- Ans
- 1. 220-210-200
  - 2. 90-80-75
  - 3. 200-180-140
  - 4. 150-160-140

Q.44 Select the option that indicates the arrangement of the following words in meaningful and logical order.

1. Word
2. Paragraph
3. Sentence
4. Letter
5. Phrase

- Ans
- 1. 1, 3, 2, 4, 5
  - 2. 2, 1, 5, 4, 3
  - 3. 5, 1, 3, 2, 4
  - 4. 4, 1, 5, 3, 2

Q.45 In the following number-pairs, the second number is obtained by applying certain mathematical operations to the first number. Select the set in which the numbers are related in the same way as are the numbers of the following sets.

(NOTE: Operations should be performed on the whole numbers, without breaking down the numbers into its constituent digits. E.g., 13 – Operations on 13 such as adding/subtracting/multiplying etc. to 13 can be performed. Breaking down 13 into 1 and 3 and then performing mathematical operations on 1 and 3 is not allowed.)

(6, 34)  
(8, 46)

- Ans
- 1. (7, 38)
  - 2. (10, 58)
  - 3. (12, 76)
  - 4. (4, 24)

Q.46 Read the given statements and conclusions carefully. Assuming that the information given in the statements is true, even if it appears to be at variance with commonly known facts, decide which of the given conclusions logically follow(s) from the statements.

Statements: All frames are rocks. All rocks are clips. All clips are towels.

Conclusion (I): All frames are towels.

Conclusion (II): At least some clips are frames.

- Ans
- 1. Only conclusion (I) follows
  - 2. Only conclusion (II) follows
  - 3. Neither conclusion (I) nor (II) follows
  - 4. Both conclusions (I) and (II) follow

Q.47 In a certain code language, 'FLEW' is coded as '8462' and 'LORD' is coded as '9736'.

What is the code for 'L' in the given code language?

- Ans
- 1. 6
  - 2. 4
  - 3. 9
  - 4. 7

Q.48 Select the set in which the numbers are related in the same way as are the numbers of the following sets.

(NOTE: Operations should be performed on the whole numbers, without breaking down the numbers into its constituent digits. E.g. 13 – Operations on 13 such as adding /deleting /multiplying etc. to 13 can be performed. Breaking down 13 into 1 and 3 and then performing mathematical operations on 1 and 3 is not allowed.)

(9, 576, 8)

(7, 252, 6)

- Ans
- 1. (15, 210, 7)
  - 2. (10, 40, 2)
  - 3. (8, 650, 10)
  - 4. (4, 82, 5)

Q.49 In a certain code language, 'SANG' is coded as '3618', and 'RANG' is coded as '6438'. What is the code for 'S' in that language?

- Ans
- 1. 1
  - 2. 8
  - 3. 3
  - 4. 6

Q.50 If 'A' stands for '+', 'B' stands for 'x', 'C' stands for '+' and 'D' stands for '-', what will come in place of the question mark '?' in the following equation?

10 B 2 D 15 A 3 C 7 = ?

- Ans
- 1. 22
  - 2. 20
  - 3. 21
  - 4. 24

Section : General Awareness

Q.1 In plant cells, which organelle is responsible for photosynthesis?

- Ans
- 1. Chloroplast
  - 2. Mitochondrion
  - 3. Lysosome
  - 4. Peroxisome

Q.2 Which compound is used to neutralise fatty acids and convert them into salts in a process called saponification?

- Ans
- 1. Sodium acetate
  - 2. Sodium fluoride
  - 3. Sodium hydroxide
  - 4. Sodium chlorate



**Q3 Which of the following values is subtracted from the numerical value of temperature expressed in Kelvin to obtain the temperature in degrees Celsius?**

- Ans
- 1. 293
  - 2. 253
  - 3. 313
  - 4. 273

**Q4 During which years did Khalji dynasty ruled over Delhi?**

- Ans
- 1. 1290 - 1320
  - 2. 1320 - 1414
  - 3. 1451 - 1526
  - 4. 1414 - 1451

**Q5 Who was elected as the 16<sup>th</sup> Speaker of the Himachal Pradesh Legislative Assembly in January 2023?**

- Ans
- 1. Jai Ram Thakur
  - 2. Kuldeep Singh Pathania
  - 3. Anurag Thakur
  - 4. Suresh Bhardwaj

**Q6 Which of the following sentences is/are correct?**  
i. According to the Census of India 2011, the total population of India is 141 crores.  
ii. Between 1911 and 1921, there was a negative rate of growth of India's population.  
iii. Between 1901 and 1951, the average annual growth of India's population did not exceed 1.33%.

- Ans
- 1. Only i and ii
  - 2. Only i and iii
  - 3. Only i
  - 4. Only ii and iii

**Q7 How do estuaries serve as critical habitats for various species?**

- Ans
- 1. Estuaries have no ecological significance.
  - 2. Estuaries provide breeding grounds and nurseries for marine organisms.
  - 3. Estuaries contribute to desertification.
  - 4. Estuaries are only important for recreational activities.

**Q8 Narmada Bachao Andolan (Save Narmada Movement) is a/an \_\_\_\_\_.**

- Ans
- 1. Social movement
  - 2. government initiative
  - 3. forest conservation movement
  - 4. project of Jal Shakti Ministry

**Q9 Which of the following bacterial infections often affects the lungs?**

- Ans
- 1. Tuberculosis
  - 2. Influenza
  - 3. Meningitis
  - 4. Herpes

Q.10 Which Chief Justice of India was sworn in as the acting President of India on 20th July 1969?

- Ans
- 1. Justice Harilal Jekisundas Kania
  - 2. Justice M Patanjali Sastri
  - 3. Justice Sudhi Ranjan Das
  - 4. Justice Mohammad Hidayatullah

Q.11 Who among the following musicians received the Padma Bhushan Award 2022 for his contributions in the field of art?

- Ans
- 1. Madan Singh Chauhan
  - 2. Chhannulal Mishra
  - 3. Rashid Khan
  - 4. Manilal Nag

Q.12 You grew a small plant in a planter. On maturity, you observed that the plant has green stem, very few branches and the stem is so soft that you could easily break it with your hands. Under which category will you put this plant?

- Ans
- 1. Tree
  - 2. Creeper
  - 3. Shrub
  - 4. Herb

Q.13 Which organelle contains enzymes for digesting cellular waste and foreign materials?

- Ans
- 1. Nucleus
  - 2. Mitochondrion
  - 3. Lysosome
  - 4. Vacuole

Q.14 Who said "a cherry that will drop into our mouth one day" about the kingdom of Awadh?

- Ans
- 1. Lord Mountbatten
  - 2. Lord Curzon
  - 3. Lord Lytton
  - 4. Lord Dalhousie

Q.15 Olympic medalist Vijender Singh belongs to which State of India?

- Ans
- 1. Punjab
  - 2. Delhi
  - 3. Haryana
  - 4. Maharashtra

Q.16 Who was the leader of the temple entry movement in 1930 at Kalaram temple, Nashik?

- Ans
- 1. Swami Achhutanand
  - 2. NG Ranga
  - 3. Mahatma Gandhi
  - 4. Dr. BR Ambedkar

Q.17 Private income minus tax payment minus non-tax payment will give us the estimate for \_\_\_\_\_.

- Ans
- 1. private income
  - 2. national income
  - 3. gross income
  - 4. personal disposable income

Q.18 Which of the following articles of the Constitution of India provides measures to ensure the enforcement of Fundamental Rights?

- Ans
- 1. Article 19
  - 2. Article 14
  - 3. Article 32
  - 4. Article 29

Q.19 The valency of Ca is 2. The valency of O is 2. What is the simplified chemical formula of Calcium oxide?

- Ans
- 1.  $\text{Ca}_2\text{O}_2$
  - 2.  $\text{CaO}$
  - 3.  $\text{CaO}_2$
  - 4.  $\text{Ca}_2\text{O}$

Q.20 What is the primary focus of the ASPIRE scheme of the Ministry of Micro, Small & Medium Enterprises, Government of India?

- Ans
- 1. Urban development
  - 2. Technology innovation
  - 3. Environmental conservation
  - 4. Establishment of livelihoods business incubation centres

Q.21 The office of the Registrar General and Census Commissioner works under which Ministry of Government of India?

- Ans
- 1. Ministry of Finance
  - 2. Ministry of Personnel, Public Grievances and Pensions
  - 3. Ministry of Home Affairs
  - 4. Ministry of Social Justice and Empowerment

Q.22 In 1800, which of the following experimental achievements was made by William Nicholson?

- Ans
- 1. Discovery of electric bulb
  - 2. Discovery of water electrolysis
  - 3. Discovery of low-cost filters for polarizing light
  - 4. Discovery of thermionic emission

Q.23 When was Swami Vivekananda born?

- Ans
- 1. 12 January 1853
  - 2. 12 January 1863
  - 3. 12 January 1866
  - 4. 12 January 1859

Q.24 Which of the following is/are a gymnosperm?

- Ans
- 1. Mosses
  - 2. Cycas
  - 3. Rose
  - 4. Fern

Q.25 Who among the following is the author of the book published in December 2021, 'The Monk Who Transformed Uttar Pradesh'?

- Ans
- 1. Amish Tripathi
  - 2. Shantanu Gupta
  - 3. Shashi Tharoor
  - 4. Yashika Dutta

Q.26 Name the scheme launched by the Prime Minister on 17 September 2023 that aims to improve the lives of artisans.

- Ans
- 1. PM Vishwakarma
  - 2. PM Shilpgram
  - 3. PM Anantakalpaaya
  - 4. PM Kalashi

Q.27 Which of the following is a macronutrient?

- Ans
- 1. Vitamins
  - 2. Carbohydrates
  - 3. Minerals
  - 4. Antioxidants

Q.28 What is the primary function of the Golgi apparatus?

- Ans
- 1. Protein synthesis
  - 2. Lipid production
  - 3. Sorting and packaging of cellular products
  - 4. Cellular respiration

Q.29 Match the following states with their percentage urban population in India, as per Census 2011.

- i) Kerala a) 10.04%
- ii) Madhya Pradesh b) 47.72%
- iii) Tamil Nadu c) 27.63%
- iv) Himachal Pradesh d) 48.45%

- Ans
- 1. i) d, ii) c, iii) b, iv) a
  - 2. i) a, ii) d, iii) c, iv) b
  - 3. i) a, ii) b, iii) c, iv) d
  - 4. i) b, ii) c, iii) d, iv) a

Q.30 It is a fact that if you drink from a plastic bottle and throw it in the dustbin, it will still be there when your grandchildren are old. What is the reason behind this?

- Ans
- 1. Plastics are biodegradable.
  - 2. Plastics are radioactive.
  - 3. Plastics are non-biodegradable.
  - 4. Plastics are heavy metals.

Q.31 \_\_\_\_\_ is referred to as paper taxes.

- Ans
- 1. Gift tax
  - 2. Corporation tax
  - 3. Customs duty
  - 4. Excise tax

Q.32 If an earthquake happens at the sea floor and one tectonic plate dips under the another, this will most probably lead to a natural disaster known as:

- Ans
- 1. Tsunami
  - 2. Typhoon
  - 3. Tornado
  - 4. Cyclone

Q.33 Name the first Finance Minister of independent India, whose statue was inaugurated by the Union Textiles Minister in Coimbatore .

- Ans
- 1. RK Shanmugam Chetty
  - 2. CD Deshmukh
  - 3. TT Krishnamachari
  - 4. Sachindra Chaudhuri

Q.34 The National Defense Fund is governed by an Executive Committee, which is chaired by the:

- Ans
- 1. President
  - 2. Prime Minister
  - 3. Vice President
  - 4. Defence Minister

Q.35 Which of the following is the correct option for using 'justify' alignment to a paragraph in a document?

- Ans
- 1. Aligns text only to the left
  - 2. Aligns text only to the right
  - 3. Aligns text to both left and right edges
  - 4. Align text in the center

Q.36 The total number of bishops in a chess game is \_\_\_\_\_.

- Ans
- 1. one
  - 2. two
  - 3. three
  - 4. four

Q.37 What is the SI unit of force?

- Ans
- 1. Volt
  - 2. Joule
  - 3. Newton
  - 4. Watt

Q.38 Which of the following is the shortcut key to create a new paragraph in MS Word?

- Ans
- 1. Ctrl + N
  - 2. Ctrl + P
  - 3. Enter
  - 4. Shift + Enter

Q.39 Which of the following is a heart-related disease?

- Ans
- 1. Diabetes
  - 2. Angina
  - 3. Acromegaly
  - 4. Goiter

Q.40 Sange Meel Se Mulaqat is a documentary on the life of \_\_\_\_\_, directed by Gautam Ghosh.

- Ans
- 1. Pandit Biswajit Roy Chowdhury
  - 2. Pandit Bismillah Khan
  - 3. Pandit Ram Narayan
  - 4. Pandit Bhimsen Joshi

Q.41 Which of the following Ministers introduced the Central Goods and Services Tax (Amendment) Bill 2023 and the Integrated Goods and Services Tax (Amendment) Bill 2023 in the Lok Sabha?

- Ans
- 1. Nirmala Sitharaman
  - 2. Harpal Singh
  - 3. Bikram Keshari Arukha
  - 4. Manohar Lal Khattar

Q.42 Arachnids belong to which subphylum of the phylum Arthropoda?

- Ans
- 1. Hexapoda
  - 2. Chelicerata
  - 3. Myriapoda
  - 4. Crustacea

Q.43 The particles that form the main part of the nucleus of an atom are together known as:

- Ans
- 1. ions
  - 2. nucleons
  - 3. electrons
  - 4. isotopes

Q.44 Which of the following committees was responsible for making recommendations that led to the 42<sup>nd</sup> Constitutional Amendment for the declaration of Fundamental Duties?

- Ans
- 1. Swaran Singh Committee
  - 2. Abid Hussain Committee
  - 3. Khusro Committee
  - 4. Raja Chelliah Committee

Q.45 Which are the two major branches of the southwest monsoon in India?

- Ans
- 1. The Arabian Sea branch and the Tibetan plateau branch
  - 2. The Arabian Sea branch and the Bay of Bengal branch
  - 3. The Himalayan Mountain branch and the Gulf of Mannar branch
  - 4. The Tibetan plateau branch and the Bay of Bengal branch

Q.46 Identify the INCORRECT pair (railway zone and headquarters) from the following.

- Ans
- 1. Central Railway Zone – Kolkata
  - 2. South-East Central Railway Zone – Bilaspur
  - 3. South Western Railway Zone – Hubli
  - 4. North Western Railway Zone – Jaipur

Q.47 Who introduced the Anusandhan National Research Foundation Bill, 2023, in the Lok Sabha?

- Ans
- 1. Dr. Jitender Singh
  - 2. Gopal Rai
  - 3. Imran Hussain
  - 4. Piyush Goyal

Q.48 Which of the following places receives rainfall from the Bay of Bengal branch of southwest monsoon?

- Ans
- 1. Panaji
  - 2. Surat
  - 3. Ratnagiri
  - 4. Kolkata

Q.49 The government of which of the following states launched the 'Nand Baba Milk Mission' scheme in June 2023?

- Ans
- 1. Himachal Pradesh
  - 2. Bihar
  - 3. Madhya Pradesh
  - 4. Uttar Pradesh

Q.50 To cherish and follow the noble ideals that inspired our national struggle for freedom is a \_\_\_\_\_ fundamental duty in the list of fundamental duties enshrined in our Indian Constitution.

- Ans
- 1. first
  - 2. second
  - 3. third
  - 4. fourth

Section : General Engineering Mechanical

Q.1 If there is flow of real fluid at fixed boundary, then no-slip condition:

- Ans
- 1. does not occur
  - 2. may or may not occur
  - 3. depends on the type of flow
  - 4. occurs

Q.2 The Kelvin-Planck statement of the Second Law states that \_\_\_\_\_.

- Ans
- 1. work can be converted completely into heat
  - 2. it is impossible to convert all the heat absorbed from a single reservoir into work
  - 3. heat cannot flow spontaneously from a colder body to a hotter body
  - 4. it is possible to convert all the heat absorbed from a single reservoir into work

Q.3 A drill bit of diameter 25 mm has cutting speed of 15.7 m/min. What is the speed of rotation of drill?

- Ans
- 1. 200 RPM
  - 2. 400 RPM
  - 3. 314 RPM
  - 4. 500 RPM

Q.4 Which of the following is NOT a lathe turning operation?

- Ans
- 1. Sawing
  - 2. Grooving
  - 3. Facing
  - 4. Threading

Q.5 If the power output of a hydraulic turbine is 100 kW and overall efficiency is 50%, then what will be the power supplied at the inlet of the turbine?

- Ans
- 1. 150 kW
  - 2. 250 kW
  - 3. 50 kW
  - 4. 200 kW

Q.6 A cooling system is essentially required in internal combustion engines to \_\_\_\_\_.

- Ans
- 1. keep the engine very hot or very cool
  - 2. remove heat at a faster rate when engine is hot
  - 3. remove about 70% of heat generated in the combustion chamber
  - 4. remove heat at a faster rate when the engine is cool

Q.7 What will be the power lost in friction assuming uniform pressure theory, when a vertical shaft of 100 mm diameter rotating at 150 r.p.m. rests on a flat end foot step bearing? The coefficient of friction is equal to 0.05 and the shaft carries a vertical load of 15 KN.

- Ans
- 1. 392.7 W
  - 2. 39.27 W
  - 3. 392.7 KW
  - 4. 39.27 KW

Q.8 Which of the following is the correct designation of the refrigerant  $\text{CCl}_3\text{F}$ ?

- Ans
- 1. R 22
  - 2. R 21
  - 3. R 11
  - 4. R 12

Q.9 Which of the following statements is INCORRECT about the air pre-heater in a steam boiler?

- Ans
- 1. In the regenerative type of air pre-heater, heat from flue gases is transferred to air through an intermediate heat storage medium.
  - 2. In the tubular type of air pre-heater, hot flue gases flow in the direction opposite to that of air travel.
  - 3. Use of the air pre-heater leads to less atmospheric pollution.
  - 4. In the tubular type of air pre-heater, hot flue gases flow through the outside of the tubes of the air pre-heater.

Q.10 Which of the following statements are correct regarding the characteristics of Entropy?  
1)It increases when heat is supplied irrespective of the fact whether temperature changes or not.  
2)It decreases when heat is removed whether temperature changes or not.  
3)It remains unchanged in all adiabatic frictionless processes.  
4)It increases if temperature of heat is lowered without work being done as in a throttling process.

- Ans
- 1. Only 2, 3 and 4
  - 2. Only 1, 2 and 3
  - 3. Only 1, 3 and 4
  - 4. 1, 2, 3 and 4



Q.11 In which of the following compressors, the top cover is bolted to the compressor housing instead of the welded steel shell?

- Ans
- 1. Semi-hermetic sealed compressor
  - 2. Axial compressor
  - 3. Open compressor
  - 4. Hermetic sealed compressor

Q.12 What is the main benefit of double volute casing over single volute casing of a centrifugal pump?

- Ans
- 1. Radial load balancing
  - 2. Less power requirement
  - 3. High efficiency
  - 4. High discharge

Q.13 Which of the following gas combination is commonly used in oxyfuel-gas welding?

- Ans
- 1. Oxygen and Nitrogen
  - 2. Oxygen and CO<sub>2</sub>
  - 3. Oxygen and H<sub>2</sub>
  - 4. Oxygen and acetylene

Q.14 The casting process that employs a permanent metal or ceramic mould, is \_\_\_\_\_.

- Ans
- 1. investment casting
  - 2. sand casting
  - 3. die casting
  - 4. centrifugal casting

Q.15 For measurement of dryness fraction of steam, use of a separating calorimeter is suitable \_\_\_\_\_.

- Ans
- 1. for any condition of steam
  - 2. when dryness fraction is greater than 1
  - 3. when dryness fraction is less than 0.95
  - 4. when dryness fraction is greater than 0.95

Q.16 The conventional depth of a cut considered in the parting operation using a lathe is \_\_\_\_\_.

- Ans
- 1. 1 mm to 2 mm
  - 2. 3 mm to 10 mm
  - 3. 12 mm to 16 mm
  - 4. 20 mm to 25 mm

Q.17 Which of the following statements is true about hit and miss governing?

- Ans
- 1. In this method of governing, none of the cycles should be idle throughout the running of engine.
  - 2. It increases the efficiency of engine.
  - 3. This method of governing requires higher weight of flywheel.
  - 4. It is a suitable governing method for heavy IC engines.

Q.18 What will be the value of the axial thrust on a wheel when there is no blade friction?

- Ans
- 1. Maximum
  - 2. Minimum
  - 3. Equal to the tangential force on the blade
  - 4. Zero

Q.19 Which of the following statements is correct about the location of centre of pressure?

- Ans
- 1. Centre of pressure coincides with the centre of gravity of the vertically immersed surface.
  - 2. Centre of pressure may lie at any location irrespective of the centre of gravity of the vertically immersed surface.
  - 3. Centre of pressure lies below the centre of gravity of the vertically immersed surface.
  - 4. Centre of pressure lies above the centre of gravity of the vertically immersed surface.

Q.20 Which of the following is NOT an example of Newtonian fluid?

- Ans
- 1. Air
  - 2. Kerosene
  - 3. Water
  - 4. Printer's ink

Q.21 A closed system undergoes a cycle consisting of two processes. Process 1-2 is an isothermal expansion whereas Process 2-1 is an isentropic compression. According to the first law of thermodynamics, which of the following statements is true for this cycle?

- Ans
- 1. Work done during Process 2-1 is zero.
  - 2. Work done during Process 1-2 is zero.
  - 3. Heat transfer during Process 2-1 is zero.
  - 4. Heat transfer during Process 1-2 is zero.

Q.22 For the H-S diagram of a vapour compression refrigeration cycle, the specific enthalpy of the refrigerant coming out from the compressor \_\_\_\_\_.

- Ans
- 1. decreases
  - 2. remains constant
  - 3. may increase or decrease
  - 4. increases

Q.23 In a Hartnell governor, if a spring of greater stiffness is used, then the governor will be:

- Ans
- 1. insensitive
  - 2. Isochronous
  - 3. less sensitive
  - 4. more sensitive

Q.24 A cantilever beam of length 2 m is subjected to a point load of 3 kN at a distance of 2 m and is subjected to a UDL of 3 kN/m for a total distance of 1.5 m from the fixed end. Calculate the shear force and bending moment at the fixed end.

- Ans
- 1. -5.75 kN, -5.545 kN-m
  - 2. -7.5 kN, -9.375 kN-m
  - 3. -10 kN, 15.254 kN-m
  - 4. -12.5 kN, -8.547 kN-m

Q.25 In which of the following areas is supercharging NOT so important?

- Ans
- 1. Racing cars
  - 2. Marine and automotive engines where weight and space are important
  - 3. Domestic bikes
  - 4. Engines working at high altitudes

Q.26 The heat rejection in Stirling cycle takes place at:

- Ans
- 1. constant enthalpy
  - 2. constant pressure
  - 3. constant volume
  - 4. constant temperature

Q.27 The distance of the centre of pressure from the free surface of the liquid is independent of the:

- Ans
- 1. depth of the centre of gravity from the free surface
  - 2. moment of inertia about the centre of gravity
  - 3. density of liquid
  - 4. area exposed to the liquid

Q.28 The overall efficiency of the turbine is given by:

- Ans
- 1. overall efficiency = mechanical efficiency<sup>2</sup> / hydraulic efficiency<sup>2</sup>
  - 2. overall efficiency = mechanical efficiency / hydraulic efficiency
  - 3. overall efficiency = hydraulic efficiency / mechanical efficiency
  - 4. overall efficiency = hydraulic efficiency × mechanical efficiency

Q.29 In actual air-conditioning applications, the heat rejection factor depends upon the:

- Ans
- 1. evaporator temperature
  - 2. evaporator and condenser temperatures
  - 3. rate of flow
  - 4. condenser temperature

Q.30 Which of the following statements best describes the second law of thermodynamics in relation to cyclic heat and work processes?

- Ans
- 1. In a cyclic process, the net heat transfer is always less than the net work done.
  - 2. In a cyclic process, the net work output can be equal to, greater than or less than the net heat input, depending on the efficiency of the process.
  - 3. In a cyclic process, the net heat transfer is equal to the net work done.
  - 4. In a cyclic process, the net heat transfer is always greater than the net work done.

Q.31 The distance of centre of pressure from free surface of liquid is independent of:

- Ans
- 1. the distance of C.G. from free surface of liquid
  - 2. the surface area
  - 3. the density of liquid
  - 4. the moment of inertia

Q.32 Isochronism in a governor is desirable when \_\_\_\_.

- Ans
- 1. the engine operates at low speeds
  - 2. the engine operates at high speeds
  - 3. one speed is desired under one load
  - 4. the engine is just getting started

Q.33 Calculate the polar moment of inertia and the maximum torque transmitted by a solid shaft of diameter 100 mm and length 1.0 m. Let the angle of twist be  $2^\circ$  and the modulus of rigidity,  $G = 80 \text{ GPa}$ .

- Ans
- 1.  $9.817 \times 10^6 \text{ mm}^4$ , 27.409 kN - m
  - 2.  $10.654 \times 10^6 \text{ mm}^4$ , 23.525 kN - m
  - 3.  $7.982 \times 10^6 \text{ mm}^4$ , 31.542 kN - m
  - 4.  $8.675 \times 10^6 \text{ mm}^4$ , 45.500 kN - m

Q.34 Which of the following is the effect of frictional resistance to the flow of the steam jet over the blade in steam turbines?

- Ans
- 1. The velocity of flow at the outlet to the moving blade is greater than that of flow at the inlet to the moving blade.
  - 2. The velocity of flow at the outlet to the moving blade is equal to that of flow at the inlet to the moving blade.
  - 3. There is no effect of frictional resistance to the flow of the steam jet over the blade.
  - 4. The velocity of flow at the outlet to the moving blade is less than that of flow at the inlet to the moving blade.

Q.35 Which part of the arc welding element/equipment is consumable?

- Ans
- 1. Electrical cables
  - 2. Electrode holder
  - 3. AC/DC transformer
  - 4. Electrode

Q.36 In a boiler test, the water supplied to a boiler per hour is 2250 kg. The mass of water in the boiler at the end of the one hour is found to be less than that at commencement by 250 kg. The coal burnt per hour is 250 kg. What will be the actual evaporation per kg of the fuel burnt of the boiler?

- Ans
- 1. 2500 kg
  - 2. 8 kg
  - 3. 250 kg
  - 4. 10 kg

Q.37 The heat transfer during constant pressure heating of a gas in a cylinder containing a sliding piston is equal to \_\_\_\_\_.

- Ans
- 1. zero
  - 2. the change in internal energy
  - 3. the work done by the piston
  - 4. the change in enthalpy

Q.38 The manometric head of a centrifugal pump is independent of which of the following factors?

- Ans
- 1. Frictional head loss in suction pipe
  - 2. Frictional losses in bearings
  - 3. Frictional head loss in delivery pipe
  - 4. Loss of head in impeller and casing

Q.39 When pressure is measured above the atmospheric pressure, it is termed as:

- Ans
- 1. vacuum pressure
  - 2. absolute pressure
  - 3. gauge pressure
  - 4. stagnation pressure

Q.40 The brake power of an engine can be measured by using a rope brake dynamometer. It is given by the expression: (Where, 'D' is diameter of the brake drum; 'W' is the weight and 'S' is the spring scale reading, 'N' Speed in rpm)

- Ans
- 1.  $\pi DN (W - S)$
  - 2.  $\pi DN (W + S)$
  - 3.  $\pi DN (W + S)$
  - 4.  $\pi DN (W - S)$

Q.41 Which of the following factors is taken into consideration when determining the maximum suction height of a centrifugal pump?

- Ans
- 1. Cavitation
  - 2. Mechanical efficiency
  - 3. Manometric efficiency
  - 4. Priming

Q.42 If  $h_1$  and  $h_2$  are enthalpies at the inlet and the outlet, respectively and  $C_1$  and  $C_2$  are inlet and outlet velocities, respectively, then which of the following statements is INCORRECT about the equation  $(\frac{C_2^2 - C_1^2}{2} = h_1 - h_2)$  for steam nozzles?

- Ans
- 1. The flow is adiabatic in steam nozzles.
  - 2. The equation considers frictional losses in the steam nozzle.
  - 3. The equation is the steady flow energy equation for steam nozzles.
  - 4. There is no mechanical work done by the steam nozzle.

Q.43 Which of the following is NOT the application for steam in industry?

- Ans
- 1. Propulsion
  - 2. Humidification
  - 3. De-atomisation
  - 4. Heating

Q.44 The zeroth law of thermodynamics is based on the concept of \_\_\_\_\_.

- Ans
- 1. heat capacity
  - 2. enthalpy
  - 3. temperature
  - 4. entropy

Q.45 Which of the following refrigeration lubricants were the first synthetic oils to be used in the refrigeration industry?

- Ans
- 1. Alkylbenzenes oil
  - 2. Mineral oil
  - 3. Polyol ester oil
  - 4. Poly alkylene glycol oil

Q.46 The fluid that becomes less viscous as it is sheared harder is called \_\_\_\_\_.

- Ans
- 1. dilatant fluid
  - 2. thixotropic fluid
  - 3. Newtonian fluid
  - 4. pseudo-plastic fluid

Q.47 'No slip condition' at a fixed surface is applicable to the flow of which type of fluids?

- Ans
- 1. Only ideal fluids
  - 2. Only Newtonian fluids
  - 3. All non-Newtonian fluids
  - 4. All real fluids

Q.48 For the laminar flow through circular pipes, shear stress distribution across a section is \_\_\_\_\_ .

- Ans
- 1. cubic
  - 2. logarithmic
  - 3. linear
  - 4. parabolic

Q.49 The mist lubrication system is generally used for \_\_\_\_\_.

- Ans
- 1. air refrigeration cycle engine
  - 2. gas engine
  - 3. four stroke cycle engine
  - 4. two stroke cycle engine

Q.50 In the vapour compression refrigeration cycle with dry saturated vapour after compression, the entropy at the end of compression is the same as the \_\_\_\_\_.

- Ans
- 1. entropy at the end of evaporation
  - 2. entropy at the end of condensation
  - 3. entropy at the end of expansion
  - 4. entropy at the start of expansion

Q.51 Which of the following is NOT a frequent pattern-making process in manufacturing?

- Ans
- 1. Sweep pattern
  - 2. Investment pattern
  - 3. Match plate pattern
  - 4. Welding pattern

Q.52 Which of the following statements is true about quantity governing?

- Ans
- 1. The compression ratio varies with charge supplied.
  - 2. The mixture strength remains the same with variation in the speed of the engine.
  - 3. This method is mostly preferred for diesel engines.
  - 4. Due to quantity governing, the engine efficiency is altered.

Q.53 When a system is undergoing constant volume process, then heat transfer is equal to:

- Ans
- 1. change in internal energy
  - 2. change in entropy
  - 3. work transfer
  - 4. change in enthalpy

Q.54 Which of the following impellers are best suited to medium sized pumps with a small amount of soft solids?

- Ans
- 1. Closed impellers
  - 2. Open impellers
  - 3. Semi-open impellers
  - 4. Semi-closed impellers

Q.55 Which of the following does NOT indicate that the refrigeration plant has to be charged with the refrigerant?

- Ans
- 1. Short cycling of compressor
  - 2. Reduction in the efficiency of the plant
  - 3. High suction pressure
  - 4. Difficult to maintain temperature of rooms and holds

Q.56 If  $N$  is the speed of the compressor in RPM, then what will be the isentropic power for a double acting compressor? Where  $W$  = work required by the compressor.

- Ans
- 1.  $WN/2$
  - 2.  $WN$
  - 3.  $2WN/60$
  - 4.  $WN/60$

Q.57 A sample of an ideal gas is compressed isothermally from volume of 4 l to 2 l. If the initial pressure is 2 atm, what is the final pressure?

- Ans
- 1. 4 atm
  - 2. 1 atm
  - 3. 2 atm
  - 4. 8 atm

Q.58 In a hot working process, metals are deformed \_\_\_\_\_.

- Ans
- 1. at their recrystallisation temperature
  - 2. below their recrystallisation temperature
  - 3. at any recrystallisation temperature
  - 4. above their recrystallisation temperature

Q.59 Which of the following is NOT a part of a bucket type steam trap?

- Ans
- 1. Guide tube
  - 2. Spiral vane
  - 3. Float
  - 4. Injector

Q.60 In the porter governor, the main constituent of controlling force is:

- Ans
- 1. friction force
  - 2. spring force
  - 3. mass of sleeve
  - 4. mass of flyball

Q.61 In case of a four-stroke diesel engine, the valve timing diagram is expressed in terms of \_\_\_\_\_.

- Ans
- 1. the linear movement of the piston with respect to TDC and BDC
  - 2. the time taken for opening and closing of the valve with respect to only TDC
  - 3. the degree of the crank angle at the time of opening and closing of the valve
  - 4. the time taken for opening and closing of the valve with respect to TDC and BDC

Q.62 Which of the following options is correct about four-stroke engines when compared with two-stroke engines?

- Ans
- 1. Thermal efficiency is higher.
  - 2. The thermodynamic cycle is completed in two strokes of the piston or in one revolution of the crankshaft.
  - 3. Lower volumetric efficiency due to lesser time taken for mixture intake
  - 4. Light weight and simplicity due to absence of the valve actuating mechanism, with the initial cost of the engine being low

Q.63 Which of the following is used to increase the temperature of steam above its saturation temperature?

- Ans
- 1. Superheater
  - 2. Steam dryer
  - 3. Economiser
  - 4. Air pre-heater

Q.64 Under which of the following conditions does the Francis turbine operate?

- Ans
- 1. High head and high discharge
  - 2. Medium head and medium discharge
  - 3. Low head and high discharge
  - 4. High head and low discharge

Q.65 The location of centre of gravity for a sphere of radius (R) from the geometrical centre is at a distance of:

- Ans
- 1.  $0.5R$
  - 2.  $R$
  - 3.  $0.25R$
  - 4.  $0$

Q.66 The function of a halide torch is:

- Ans
- 1. detecting leakage of the refrigerant
  - 2. defrosting of the cooling coil
  - 3. superheating the vapour refrigerant
  - 4. facilitating better lubrication in the refrigerator

Q.67

Determine the stress induced in the steel bars of reinforced concrete structure, if the modular ratio for steel and concrete is 14.5 and the stress applied on the concrete is 2.5 MPa.

- Ans
- 1. 30.25 MPa
  - 2. 24.50 MPa
  - 3. 36.25 MPa
  - 4. 42.75 MPa



Q.68 Total gradient line (or total energy line) is parallel to hydraulic gradient line with a vertical distance of \_\_\_\_\_. (The symbols have their usual meanings.)

- Ans
- 1.  $\frac{p}{w}$
  - 2.  $\frac{v^2}{2g}$
  - 3.  $\left(\frac{p}{w}\right) + \left(\frac{v^2}{2g}\right) + z$
  - 4.  $\left(\frac{p}{w}\right) + z$

Q.69 In a milling machine, bulky workpieces of irregular shapes are clamped directly on the milling machine table by using \_\_\_\_\_.

- Ans
- 1. V-blocks
  - 2. T-bolts and clamps
  - 3. swivel vise
  - 4. angle plates

Q.70 Which of the following prevents the high-pressure vapour refrigerant from flowing back to the evaporator in rotating blade type rotary compressor?

- Ans
- 1. Throttling valve
  - 2. Pressure valve
  - 3. Check valve
  - 4. Safety valve

Q.71 What will not happen if the liquid has greater adhesion than cohesion?

- Ans
- 1. The angle of contact will be less than  $90^\circ$  in a small diameter tube.
  - 2. Liquid will wet a solid surface.
  - 3. Liquid will tend to rise at the point of contact.
  - 4. Liquid surface will be concave downwards in a small diameter tube.

Q.72 Which of the following evaporators are used for refrigeration units of 2 to 250 TR capacity?

- Ans
- 1. Flooded shell and tube evaporators
  - 2. Shell and coil evaporators
  - 3. Dry expansion shell and tube evaporators
  - 4. Plate evaporators

Q.73 The Kaplan turbine is an example of \_\_\_\_\_.

- Ans
- 1. mixed-flow turbine
  - 2. radial flow turbine
  - 3. tangential flow turbine
  - 4. axial flow turbine

Q.74 The maximum frictional force that comes in play when a body just begins to slide over the surface of another body is called:

- Ans
- 1. dynamic friction
  - 2. limiting friction
  - 3. static friction
  - 4. kinetic friction

Q.75 Which of the following assertions related to drilling is true?

- Ans
- 1. Drilling is a process that uses a hammer to make a hole in a workpiece.
  - 2. Drilling is a process that uses a rotating tool to make a hole in a workpiece.
  - 3. Drilling is a process that uses a saw to make a hole in a workpiece.
  - 4. Drilling is a process that uses a non-rotating tool to make a hole in a workpiece.

Q.76 When the compressor and motor operate on the same shaft and are enclosed in a common casing, they are known as \_\_\_\_\_.

- Ans
- 1. hermetic sealed compressors
  - 2. reciprocating compressors
  - 3. axial compressors
  - 4. centrifugal compressors

Q.77 Name the welding defect in which we observe a long and continuous visual separation line between the base metal and the heat affected zone.

- Ans
- 1. Undercut
  - 2. Lamellar tearing
  - 3. Incomplete fusion
  - 4. Hot cracking

Q.78 Which of the following statements is true about an SI engine in comparison to a CI engine?

- Ans
- 1. The operating speed is very high.
  - 2. The air-fuel ratio is high.
  - 3. The compression ratio is comparatively high.
  - 4. The cost of running is comparatively low.

Q.79 In the process of brazing, the filler metal is drawn into the joint by means of \_\_\_\_\_.

- Ans
- 1. High diffusion
  - 2. Capillary action
  - 3. Surface tension
  - 4. Low viscosity

Q.80 Which of the following statements is INCORRECT about no slip boundary condition?

- Ans
- 1. During no slip condition the fluid velocity at all fluid–solid boundaries is equal to that of the solid boundary.
  - 2. In case of the no slip boundary condition at a fixed solid boundary, the fluid will have zero velocity.
  - 3. In case of the no slip boundary condition at a fixed solid boundary, the fluid will have some velocity relative to the boundary.
  - 4. The no slip condition can be defined for viscous flows.

Q.81 The volumetric efficiency of a single-stage reciprocating air compressor is the ratio of the:

- Ans
- 1. displacement of the compressor to the free air delivered
  - 2. swept volume to the effective swept volume
  - 3. swept volume to the clearance volume
  - 4. free air delivered to the displacement of the compressor

Q.82 A complex geometry is placed in the X-Y plane. If the geometry is found to be symmetrical about the Y-axis, then which of the following is correct to calculate the centre of gravity?

- Ans
- 1. X co-ordinate is zero
  - 2. Z co-ordinate is a non-zero value
  - 3. X co-ordinate is a non-zero value
  - 4. Y co-ordinate is zero

Q.83 Which of the following statements is true about the fuel feed pump used for diesel engines?

- Ans
- 1. When the plunger of the feed pump is lifted upwards, the inlet valve remains open. Therefore, it is not suitable to inject fuel at that time.
  - 2. It is a centrifugal type pump.
  - 3. The plunger of the fuel feed pump is actuated by the governor.
  - 4. It is a spring-loaded, plunger type reciprocating pump.

Q.84 Carbon steel contains a carbon percentage of about 0.21%. The possible type of carbon steel is \_\_\_\_\_.

- Ans
- 1. mild steel
  - 2. stainless steel
  - 3. alloy steel
  - 4. medium carbon steel

Q.85 The surging phenomenon in a centrifugal compressor occurs when the refrigeration load decreases to below:

- Ans
- 1. 55% of the rated capacity
  - 2. 45% of the rated capacity
  - 3. 65% of the rated capacity
  - 4. 35% of the rated capacity

Q.86 When the fluid pressure is measured above the absolute zero pressure, the measured pressure is known as \_\_\_\_\_.

- Ans
- 1. vacuum pressure
  - 2. atmospheric pressure
  - 3. absolute pressure
  - 4. gauge pressure

Q.87 A cyclic heat engine takes 40 kJ of heat from a 100°C temperature reservoir. If it gives 40 kJ of work, then which of the following statements is correct?

- Ans
- 1. The engine violates the Kelvin Planck's statement
  - 2. The engine violates the 1st law of thermodynamics.
  - 3. The engine violates the Clausius statement.
  - 4. The engine violates 1st law of thermodynamics as well as Kelvin Planck's statement.

Q.88 Variation of power input with speed at constant discharge in case of a centrifugal pump is \_\_\_\_\_.

- Ans
- 1. linear
  - 2. cubic
  - 3. logarithmic
  - 4. parabolic

Q.89 The process that involves passage of a higher-pressure fluid through a narrow constriction is called:

- Ans
- 1. polytropic process
  - 2. throttling process
  - 3. hyperbolic process
  - 4. free expansion process

Q.90 Which of the following machines violates the Kelvin Planck's statement?

- Ans
- 1. PMM1
  - 2. Irreversible heat engine
  - 3. PMM2
  - 4. Reversible heat engine

Q.91 Which of the following is the assumption of Air Standard Cycles?

- Ans
- 1. The working medium has variable specific heat with varying temperature
  - 2. The working medium is assumed to be a real gas
  - 3. Some heat is assumed to be rejected to a constant low temperature sink
  - 4. Heat is assumed to be supplied from chemical reactions during the cycle

Q.92 In the battery ignition system for SI engines, with increase in the speed, the \_\_\_\_\_.

- Ans
- 1. sparking voltage remains the same
  - 2. sparking voltage first increases and then becomes constant
  - 3. sparking voltage drops
  - 4. sparking voltage increases

Q.93 If a point is to be at the free surface of a liquid open to the atmosphere, where the pressure is the atmospheric pressure  $P_{atm}$ , then the gauge pressure at a depth 'h' from the free surface becomes:

- Ans
- 1.  $P_{gauge} = \rho gh$
  - 2.  $P_{gauge} = P_{atm} - \rho gh$
  - 3.  $P_{gauge} = P_{atm} + \rho gh$
  - 4.  $P_{gauge} = P_{atm}$

Q.94 The mass transfer process in an open system is commonly modelled using the \_\_\_\_\_ equation.

- Ans
- 1. zeroth law of thermodynamics
  - 2. third law of thermodynamics
  - 3. mass balance
  - 4. second law of thermodynamics

Q.95 The given figure shows the p-V diagram of:

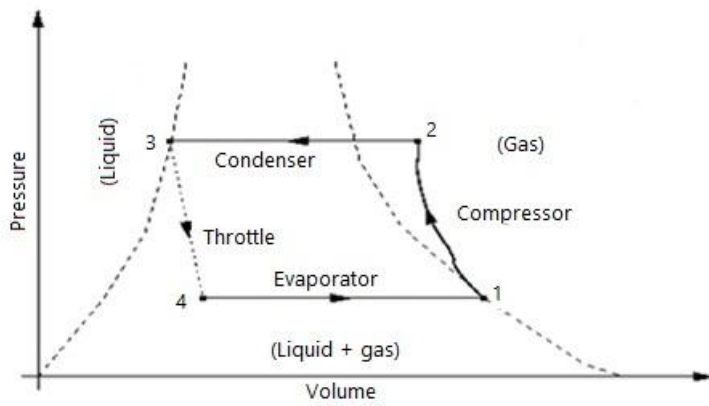

- Ans
- 1. vapour absorption refrigeration system
  - 2. Electrolux refrigeration system
  - 3. vapour compression refrigeration system
  - 4. aircraft refrigeration system

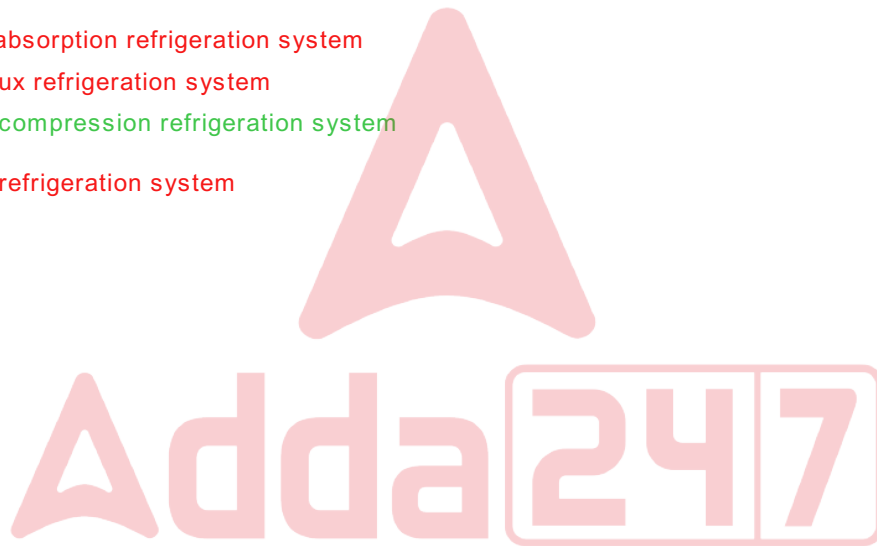

Q.96 Which of the following is NOT a type of sawing?

- Ans
- 1. Circular sawing
  - 2. Straight sawing
  - 3. Band sawing
  - 4. Hack sawing

Q.97 Which of the following is correct for Pelton wheel?  
Where,  $\alpha$  &  $\beta$  = guide blade angle at inlet and outlet, respectively  
 $\Theta$  &  $\phi$  = vane angle at inlet and outlet, respectively

- Ans
- 1.  $\alpha = 0^\circ$  and  $\beta = 0^\circ$
  - 2.  $\alpha = 0^\circ$  and  $\Theta = 0^\circ$
  - 3.  $\beta = 0^\circ$  and  $\phi = 0^\circ$
  - 4.  $\alpha = 0^\circ$  and  $\phi = 0^\circ$

Q.98 Which of the following claims about the irreversibility of a system is true?

- Ans
- 1. Irreversible processes violate the zeroth law of thermodynamics.
  - 2. Irreversible processes violate the first law of thermodynamics.
  - 3. Irreversible processes increase the entropy of the system.
  - 4. Irreversible processes are always spontaneous.

Q.99 The casting process that employs a wax pattern coated with a ceramic shell to make the mould, is \_\_\_\_\_.

- Ans
- 1. centrifugal casting
  - 2. sand casting
  - 3. die casting
  - 4. investment casting

Q.100 Enthalpy of a system in an open flow is given by  $h = u + pv$ , where  $pv$  is the \_\_\_\_\_.

- Ans
- 1. flow work
  - 2. momentum energy
  - 3. external work
  - 4. moving boundary work

