

Contents

| | |
|---|----|
| 200+ General Knowledge MCQs for Defence 2023 Exam | 2 |
| 200+ English MCQs for Defence 2023 Exam | 29 |
| 100+ Quantitative MCQs for Defence 2023 Exam | 54 |
| 100+ Reasoning MCQs for Defence 2023 Exam | 72 |



200+ General Knowledge MCQs for Defence Exam

Q1. What is the name of the court poet of King Harshavardhana?

- (a) Tulsidas
- (b) Banabhatta
- (c) Surdas
- (d) Raskhan

Q2. Which emperor wrote the play 'Nagananda' in Sanskrit language?

- (a) Prabhakaravardhana
- (b) Harshavardhana
- (c) Chandragupta II
- (d) Bindusara

Q3. Takshashila University was located between which two rivers?

- (a) Indus and Jhelum
- (b) Jhelum and Ravi
- (c) Beas and Indus
- (d) Satluj and Indus

Q4. Who is the most prominent god of 'Rig Veda'?

- (a) Indra
- (b) Agni
- (c) Pashupati
- (d) Vishnu

Q5. Big landlords or warrior chiefs in the seventh century were acknowledged as _____ by the existing kings?

- (a) Rashtrakutas
- (b) Chalukya
- (c) Samantas
- (d) Brahmanas

Q6. Who amongst the following was the successor of Sikh Guru Har Krishan?

- (a) Guru Angad Dev
- (b) Guru Tegh Bahadur
- (c) Guru Hargobind
- (d) Guru Amar Das

Q7. The queen with the title Didda ruled over which part of India between 980 - 1003?

- (a) Avadh
- (b) Kashmir
- (c) Sindh
- (d) Bengal

Q8. Jama Masjid of Delhi was built in which century?

- (a) 15th
- (b) 16th
- (c) 17th
- (d) 18th

Q9. In which year did the Portuguese captured Goa from Bijapur?

- (a) 1498
- (b) 1510
- (c) 1516
- (d) 1569

Q10. Who among the following were the pioneers in opening oceanic trade with India?

- (a) Dutch
- (b) English
- (c) French
- (d) Portuguese

Q11. The tax collected by Marathas was known as

- (a) Chauth
- (b) Pilgrim Tax
- (c) Jazia
- (d) Charai

Q12. At which of the following places did Hyder Ali built a modern arsenal?

- (a) Dindigul
- (b) Mysore
- (c) Srirangappattanam
- (d) Arcot

Q13. Who planted the "Tree of Liberty" at Srirangapatnam?

- (a) Chikka Krishna Raj
- (b) Devraj
- (c) Hyder Ali
- (d) Tipu Sultan

Q14. The South Indian ruler who introduced sericulture as an agro-industry in his kingdom was

- (a) Tipu Sultan
- (b) Hyder Ali
- (c) Krishnadeva Raya
- (d) Rajaraja II

Q15. The Modi script had been employed in the documents of the

- (a) Hoysalas
- (b) Zamorins
- (c) Marathas
- (d) Wodeyaras

Q16. Who was the founder of Atmiya Sabha

- (a) Bhagat Singh
- (b) Mahatma Gandhi
- (c) Ram Mohan Roy
- (d) Motilal Nehru

Q17. Amongst the following, who cooperated with Raja Ram Mohan Roy in the implementation of his educational programmes?

- (a) Dwarkanath Tagore
- (b) David Hare
- (c) Henri Derozio
- (d) William Jones

Q18. The Vedas contain all the truth was interpreted by?

- (a) Swami Vivekananda
- (b) Swami Dayananda
- (c) Raja Rammohan Roy
- (d) None of the above

Q19. Uplift of the backward classes was the main programme of the—

- (a) Prarthana Samaj
- (b) Satya Shodhak Samaj
- (c) Arya Samaj
- (d) Ramakrishna Mission

Q20. Who among the following was a social reformer belonging to the Mali Community of Pune?

- (a) ThakkarBhappa
- (b) BR Ambedkar
- (c) JyotibaPhule
- (d) None of these

Q21. Which one of the following is correctly matched?

- (a) Brahmo Samaj - Annie Basant
- (b) Arya Samaj – Swami Dayanand Saraswati
- (c) Ram Krishna Mission - Keshab Chandra Sen
- (d) Theosophical Society – Vivekananda

Q22. By the Act of 1858, the powers of the Board of Control and the Court of Directors were transferred to _____.

- (a) The Secretary of State
- (b) Parliament
- (c) Viceroy
- (d) Commander-in-Chief

Q23. The maximum number of additional members for the council of Bengal was raised from 20 to _____ in Indian council act 1909.

- (a) 60
- (b) 50
- (c) 70
- (d) 25

Q24. The 1909 Indian Council Act is also known as

- (a) The Chelmsford Reforms
- (b) The Pitts India Act
- (c) The August offer
- (d) The Minto-Morley Reforms

Q25. The Company's monopoly of Trade was abolished by the Act of

- (a) 1793
- (b) 1813
- (c) 1833
- (d) Pitt's India Act

Q26. Which of the following is associated with Lord Wellesley, the Governor General of India from 1798 to 1805?

- (a) Doctrine of Lapse
- (b) Subsidiary Alliance
- (c) First Mysore War
- (d) Conquest of Rajputana

Q27. Curzon Wyllie, who was murdered by Madan Lal Dhingra in London, was—

- (a) Secretary of State for India
- (b) Adviser to the Secretary of State for India
- (c) Law Member
- (d) Governor of Bengal

Q28. Who among the following Governor General created the Covenanted Civil Service of India which later came to be known as the Indian Civil Service?

- (a) Warren Hastings
- (b) Wellesley
- (c) Cornwallis
- (d) William Bentinck

Q29. Who founded Swadesh Bandhaw Samiti?

- (a) Ashwin Kumar Dutt
- (b) Pulin Das
- (c) Surya Sen
- (d) Barindra Ghosh

Q30. Who said that the constant 'drain of wealth' from India was responsible for India's economic miseries?

- (a) BC Pal
- (b) BP Wadia
- (c) Dadabhai Naoroji
- (d) GS Arundale

Q31. The ____ is a key factor in making the Gram Panchayat play its role and to be responsible.

- (a) Secretary
- (b) Gram Sabha
- (c) Only Sarpanch
- (d) Block Development officer



Q32. Which among the following is NOT a level of Government in India?

- I. Local level government
 - II. State level government
 - III. National level government
- (a) Only I
(b) Only II
(c) Only III
(d) No option is correct

Q33. The idea of people's participation in the Panchayati Raj System extends to how many other levels?

- (a) 1
(b) 2
(c) 4
(d) 5

Q34. Which of the following organ of the government refers to a smaller group of people who are responsible for implementing laws and running the government?

- I. The Judiciary
 - II. The Executives
 - III. The Legislature
- (a) Only I
(b) Only II
(c) Only III
(d) No option is correct

Q35. In which of the following countries fascism was originated?

- (a) Italy
(b) Japan
(c) France
(d) Russia

Q36. Who gave the concept of 'Separation of Powers' related to different forms of governments?

- (a) Montesquieu
(b) Aristotle
(c) Plato
(d) Hobbes

Q37. According to Indian Constitution, there are three organs of government. Which among the following is/are NOT an organ/organs of it

- I. The legislature
 - II. The Media
 - III. The Judiciary
- (a) Only I
(b) Only II
(c) Only III
(d) Only I and III

Q38. _____ prevents the Panchayat from doing wrong things like misusing money or favouring certain people.

- (a) Gram Sabha
(b) District Collector
(c) Sarpanch
(d) Secretary

Q39. How many levels of Government are there in India?

- (a) 1
(b) 2
(c) 3
(d) 4

Q40. The states were reorganised on linguistic basis in

- (a) 1947
(b) 1951
(c) 1956
(d) 1966

Q41. The first commission appointed by the Government in 1948 to examine the case for the reorganisation of states on linguistic basis was headed by

- (a) Justice Wanchoo
(b) Justice M C Mahajan
(c) Justice S K Dhar
(d) None of the above

Q42. The famous JVP Committee consisting of Jawaharlal Nehru, Vallabhbhai Patel and Pattabhi Sitaramayya, was appointed in December 1948 to

- (a) examine the case of establishment of secular polity in the country
(b) examine the issue of reorganisation of states on linguistic basis
(c) determine the compensation to be paid to the rulers of Indian states consequent to the merger of their states with India
(d) None of the above

Q43. Which of the following formed the State Reorganisation Commission group (1953)?

- (a) Fazl Ali and Kanjru
(b) Kanjru and Katju
(c) Katju and Fazl Ali
(d) Pannikar and Katju

Q44. The States Reorganisation Commission, set up in 1953 to consider the demand for linguistic states, was headed by

- (a) Fazal Ali
(b) K M Pannikkar
(c) H N Kanjru
(d) M C Mahajan

Q45. The States Reorganisation Act, 1956, divided the entire country into

- (a) 22 states and 9 union territories
(b) 14 states and 6 union territories
(c) 17 states and 7 union territories
(d) four categories of states

Q46. After which five year plan, 'The Rolling Plan' was implemented?

- (a) Third Plan
(b) Fifth Plan
(c) Seventh Plan
(d) Ninth Plan

Q47. Which tax causes a burden on the poorer section of the society?

- (a) Direct Tax
- (b) Indirect Tax
- (c) Both Direct and Indirect Tax
- (d) None of these

Q48. Which of the following is represented by 'Lorenz Curve'?

- (a) Employment
- (b) Inflation
- (b) Deflation
- (d) Income Distribution

Q49. _____ is an alternative way of representing the production function.

- (a) The Short Run
- (b) The Long Run
- (c) Isoquant
- (d) Average product

Q50. In a market system, the central problems regarding how much and what to produce are solved through the coordination of economic activities brought about by _____ signals.

- (a) Supply
- (b) Demand
- (c) Price
- (d) Stock Market

Q51. _____ says that the marginal product of a factor input initially rises with its employment level. But after reaching a certain level of employment, it starts falling.

- (a) Law of diminishing marginal product
- (b) Law of variable proportions
- (c) The Short Run
- (d) The Long Run

Q52. Who estimated the National Income for the first time in India?

- (a) Mahalanobis
- (b) Dadabhai Naoroji
- (c) V K R V Rao
- (d) Sardar Patel

Q53. A supply function expresses the relationship between

- (a) price and demand
- (b) price and consumption
- (c) price and output
- (d) price and selling cost

Q54. "Interest is a reward for parting with liquidity" is according to

- (a) Keynes
- (b) Marshall
- (c) Haberler
- (d) Ohlin

Q55. Special Economic Zone (SEZ) concept was first introduced in

- (a) China
- (b) Japan
- (c) India
- (d) Pakistan

Q56. The first protocol to ban the emissions of chlorofluorocarbons in the atmosphere was made in

- (a) Montreal
- (b) Osaka
- (c) Geneva
- (d) Florida

Q57. One of the leading producers of asbestos in the world is:

- (a) Australia
- (b) Russia
- (c) Canada
- (d) Armenia

Q58. Where is the Great Barrier Reef located ?

- (a) Pacific Ocean
- (b) Indian Ocean
- (c) Atlantic Ocean
- (d) Arctic Ocean

Q59. The smallest island country in the Indian Ocean is ?

- (a) Maldives
- (b) Sri Lanka
- (c) Mauritius
- (d) Madagascar

Q60. Which is the largest metals trading centre?

- (a) Johannesburg
- (b) London
- (c) New York
- (d) Singapore

Q61. The largest producer of Lac in India is

- (a) Chattisgarh
- (b) Jharkhand
- (c) West Bengal
- (d) Gujarat

Q62. A tropical deciduous plant special to the Deccan plateau is

- (a) Teak
- (b) Shisam
- (c) Sandalwood
- (d) Sal

Q63. Bandhavgarh National Park is located in which State?

- (a) Maharashtra
- (b) Madhya Pradesh
- (c) Gujarat
- (d) Jharkhand

Q64. Which is called the "Lake District of India"?

- (a) Nainital
- (b) Shimla
- (c) Gangtok
- (d) Matheran

Q65. Which of the following is/are 'rain cloud'?

- 1. Cirrus
- 2. Nimbostratus
- 3. Cumulonimbus
- 4. Altocumulus
- (a) 1 and 2 only
- (b) 2 and 3 only
- (c) 3 and 4 only
- (d) 1 and 4 only

Q66. The disconnected lines drawn on a map for showing slope

- (a) Bench marks
- (b) Contours
- (c) Form lines
- (d) Hachure

Q67. Precipitation in the form of a mixture of rain and snow is called -

- (a) Drizzle
- (b) Hail
- (c) Sleet
- (d) Snow

Q68. Which sanctuary in India is famous for Rhinoceros and in which state is it located?

- (a) Gir, Gujarat
- (b) Kaziranga, Assam
- (c) Ranthambore, Rajasthan
- (d) Corbett, Uttarakhand

Q69. Three crops that contribute maximum to global food grain production are _____.

- (a) Wheat, rice, barley
- (b) Rice, maize, sorghum
- (c) Wheat, maize, sorghum
- (d) Wheat, rice, maize

Q70. Which of these waves/winds is also known as 'Doctor wind'?

- (a) Sirocco
- (b) Harmattan
- (c) Loo
- (d) None of these

Q71. "Sirius", the brightest star outside solar system, is also called _____.

- (a) Cat star
- (b) Dog star
- (c) Fox star
- (d) Lion star

Q72. Pagladia Dam Project is located in which state?

- (a) Arunachal Pradesh
- (b) Sikkim
- (c) Assam
- (d) West Bengal

Q73. 'Gir Kesar', which has been given the Geographical Indication (GI) tag, is a famous variety of which among the following?

- (a) Saffron
- (b) Pepper
- (c) Mango
- (d) Sweat

Q74. Which of the following is not an example of Point Source of pollution?

- (a) Oil refinery wastewater
- (b) Noise from Jet engine
- (c) Air pollution from forest fire
- (d) Pollutants mixed in rainwater runoff

Q75. The Tuirial Hydroelectric Power Project (HEPP) is located in which state?

- (a) Kerala
- (b) Mizoram
- (c) Nagaland
- (d) Assam

Q76. The gravitational force of attraction between two bodies is _____ the product of their masses.

- (a) directly proportional to the square of
- (b) inversely proportional to
- (c) inversely proportional to the square of
- (d) directly proportional to

Q77. Find the acceleration (in m/s^2) produced in a body of mass 10 kg when a force of 20 N is applied on it.

- (a) 200
- (b) 4
- (c) 2
- (d) 100

Q78. The product of mass of a body and the acceleration produced in it equals the _____ acting on it.

- (a) force
- (b) impulse
- (c) torque
- (d) kinetic energy

Q79. The energy of wind is-

- (a) Only potential
- (b) Only kinetic
- (c) Electrical
- (d) Potential and kinetic both

Q80. Photovoltaic cells are:

- (a) Solar cells
- (b) Thermal cells
- (c) Sulphur cells
- (d) Molar cells

Q81. Which of the following is the best fire-extinguisher?

- (a) Water
- (b) Oxygen
- (c) Carbon-dioxide
- (d) Soil

Q82. Which statements are CORRECT?

I. In early 1930's Nylon was prepared from coal, water and air.

II. Nylon was the first fully synthetic fibre.

III. Nylon fibre was strong, elastic and light.

- (a) Only I and II
- (b) Only I and III
- (c) Only II and III
- (d) All I, II and III

Q83. Which of the following statement is CORRECT?

- (a) Gold and Silver are not ductile
- (b) Phosphorus and Nitrogen are ductile
- (c) Copper and Platinum are ductile
- (d) Sulphur and Phosphorus are sonorous

Q84. Sphalerite is an ore/mineral of -

- (a) Mercury
- (b) Molybdenum
- (c) Silver
- (d) Zinc

Q85. Which drug is used to cure Hypertension?

- (a) Risedronate
- (b) Diazepam
- (c) Folic Acid
- (d) Hydralazine

Q86. Which of the following represents the pair of sex chromosomes in men?

- (a) XY
- (b) XX
- (c) YY
- (d) No option is correct.

Q87. Scientists of which country have developed working human skeletal muscle from stem cells in the laboratory for the first time?

- (a) China
- (b) Japan
- (c) India
- (d) United States of America

Q88. The rhythmic contraction of the lining of muscles of canal to push the food along the gut is called ____.

- (a) Peristalsis
- (b) Facilitation
- (c) Guttation
- (d) No option is correct

Q89. Which of the following is the main end product of carbohydrate digestion?

- (a) Fats
- (b) Lipids
- (c) Glucose
- (d) Cellulose

Q90. Which of the following glands is a source of the enzyme Ptyalin?

- (a) Pancreas
- (b) Thyroid Gland
- (c) Pituitary Gland
- (d) Salivary Glands

Q91. A body of mass 4 kg accelerates from 15 m/s to 25 m/s in 5 seconds due to the application of a force on it. Calculate the magnitude of this force (in N).

- (a) 32
- (b) 8
- (c) 16
- (d) 64

Q92. During _____ motion of an object along a straight line, the change in velocity of the object for any time interval is zero.

- (a) Linear
- (b) Translational
- (c) Equilibrium
- (d) Uniform

Q93. What is the resistance (in Ω) of an electrical component if a current of 0.1 A passes through it on application of 5 V of potential difference across it?

- (a) 0.5
- (b) 100
- (c) 50
- (d) 1

Q94. The motion of a freely falling body is an example of _____ accelerated motion.

- (a) Non-uniformly
- (b) Uniformly
- (c) Uniquely
- (d) Specially



Q95. Find the resistance (in mega Ω) of a wire of length 20m, cross sectional area 1 cm^2 and made of a material of resistivity $200 \Omega \text{m}$.

- (a) 40
- (b) 4000
- (c) 80
- (d) 2000

Q96. Why metals conduct electricity?

- (a) Because of low melting point
- (b) Because of high tensile strength
- (c) Because of free electrons
- (d) Because of high atomic density

Q97. Which atmospheric layer contains ozone layer?

- (a) Troposphere
- (b) Mesosphere
- (c) Stratosphere
- (d) Ionosphere

Q98. _____ fiber is used in making bulletproof vests.

- (a) Nylon-66
- (b) Terylene
- (c) Kevlar
- (d) Lexan

Q99. Manganite is an ore/mineral of -

- (a) Beryllium
- (b) Chromium
- (c) Manganese
- (d) Copper

Q100. Pentane has _____ structural isomers.

- (a) 1
- (b) 2
- (c) 3
- (d) 4

Q101. The Chola kingdom mostly ruled which region of India?

- (a) East
- (b) West
- (c) North
- (d) South

Q102. Group of Monuments at Hampi was built by?

- (a) Harihara and Bukka
- (b) Udayin and Shishunaga
- (c) Devavarman and Vainya
- (d) Maravarman and Sirmara

Q103. According to the categories of land mentioned in the Chola inscriptions _____ was known as the land for the maintenance of schools?

- (a) Vellanvagai
- (b) Brahmadeya
- (c) Shalabhoga
- (d) Devadana

Q104. Old stone age people

- (a) wore cotton clothes
- (b) wore leaves, barks of trees and skin of animals
- (c) wore woollen clothes
- (d) none of the above

Q105. The first animal tamed by primitive man was

- (a) cow
- (b) horse
- (c) dog
- (d) goat

Q106. The Mongols under _____ invaded Transoxiana in north-east Iran in 1219.

- (a) Timur Lang
- (b) Nadir Shah
- (c) Ahmed Shah Abdali
- (d) Genghis Khan

Q107. Dara Shikoh was killed in conflict with his brother _____.

- (a) Jahangir
- (b) Aurangzeb
- (c) Babur
- (d) Shah Jahan

Q108. The Arabic work of Al-Biruni that gave an account of the subcontinent is called _____.

- (a) Kitab-al-Hind
- (b) Kitab-al-Bharat
- (c) Pustak-al-Hind
- (d) Pustak-al-Bharat

Q109. Which of the following is related to the Tinkathiya Pratha?

- (a) Champaran
- (b) Kheda
- (c) Bardoli
- (d) Darbhanga

Q110. Which of the following work is not credited to Lord Dalhousie?

- (a) Merger of Punjab
- (b) Merger of Bengal
- (c) Merger of Mysore
- (d) Merger of Satara

Q111. Which of the following was not done during the time of Lord Curzon?

- (a) Partition of Bengal
- (b) Punjab Land Alienation Act
- (c) Establishment of the Famine Commission
- (d) Formation of Hunter Commission

Q112. Where did the telegraph line be laid first?

- (a) Calcutta to Diamond Harbour
- (b) Agra to Jaipur
- (c) Delhi to Shimla
- (d) Raniganj to Calcutta

Q113. How long the Non-cooperation Movement was conducted?

- (a) April 1920 to February 1922
- (b) August 1920 to February 1922
- (c) June 1920 to December 1922
- (d) December 1920 to June 1922

Q114. Who led the English Army in the Battle of Buxar?

- (a) Lord Clive
- (b) Vensittart
- (c) Hector Munro
- (d) Eyre Coot

Q115. Which of the following rebellion / agitation did NOT happen in the area of Bengal?

- (a) Sannyasi Rebellion
- (b) Chuar Rebellion
- (c) Pagal Panthi rebellion
- (d) Baghera Rebellion

Q116. Who gave the title of Raja to Ranjit Singh?

- (a) Diwan Shah
- (b) Lord Lake
- (c) Zaman Shah
- (d) King of Kashmir

Q117. For the first time in India, the Kisan Diwas was celebrated on which of the following years?

- (a) 1936
- (b) 1937
- (c) 1930
- (d) 1926

Q118. In 1852, who published the newspaper 'Satyaprakash' in Gujarati?

- (a) Gangadhar Rao
- (b) Vishnu Shastri
- (c) Gopal Hari Deshmukh
- (d) Karsandas Mulji

Q119. Who was elected the President of All India Workers and Peasants Party in Calcutta in 1928?

- (a) M.N. Joglekar
- (b) Shripad Amrit Dange
- (c) Sohan Singh Josh
- (d) Mujaffar ahmed

Q120. Whom did Lord Minto send to Ranjit Singh to make a peace immediate before the Treaty of Amritsar (1809)?

- (a) Robert Rebert
- (b) Joshua Child
- (c) Ochterlony
- (d) Charles Metcalfe

Q121. The famous Cossijurah Case of Bengal happened in whose reign?

- (a) Warren Hastings
- (b) Lord Cornwallis
- (c) John Shore
- (d) Wellesley

Q122. Who of the following operated the first regular trade union in India ?

- (a) M.N. Lokhande
- (b) B.P. Wadia
- (c) Shashipad Banerjee
- (d) N.M. Joshi

Q123. Which Governor General of India used to write poetry with the name of "Owen Meredith"?

- (a) Lord Dalhousie
- (b) Lord Ripon
- (c) Lord Lytton
- (d) Lord Canning

Q124. The per capita income in India was Rs. 20/- in 1867-68, was ascertained for the first time by _____.

- (a) MG Ranade
- (b) Sir W Hunter
- (c) RC Dutt
- (d) Dadabhai Naoroji

Q125. Which of the following events is NOT considered for the time being of Viceroy Lord Lytton?

- (a) Second Afghan War
- (b) Burma war
- (c) Arms Act
- (d) Press Act

Q126. Which of the following pairs is not correctly matched?

- (a) Munda Rebellion : 1899
- (b) Vellore Mutiny: 1806
- (c) Santhal Rebellion: 1855
- (d) Chuar Rebellion: 1870

Q127. Which of the following organizations was established outside India?

- (a) Indian Association
- (b) East India Association
- (c) Bengal-British India Society
- (d) India league

Q128. Who of the following leaders is NOT associated with Champaran Satyagraha?

- (a) Anugraha Narain Sinha
- (b) J.B. Kripalani
- (c) Braj Kishore Prasad
- (d) Sardar Patel

Q129. In which of the following years sea travel has been made mandatory for Indian soldiers?

- (a) 1854 AD
- (b) 1856 AD
- (c) 1857 AD
- (d) 1858 AD

Q130. The Indian Council Act of 1892 was based on which plan?

- (a) Northbrook Plan
- (b) Dufferin Plan
- (c) Ripon Plan
- (d) Gladstone Plan

Q131. Anti-defection law was passed in which Constitutional Amendment Act?

- (a) 41st Constitutional Amendment Act
- (b) 46th Constitutional Amendment Act
- (c) 48th Constitutional Amendment Act
- (d) 52th Constitutional Amendment Act

Q132. If any Fundamental Right of a citizen is breached, then under Article 32 of Indian Constitution he can directly go to the _____.

- (a) Chief Minister of state
- (b) Prime Minister of India
- (c) Supreme Court of India
- (d) Governor of state

Q133. Which type of city administration controls transitional areas (from rural to urban)?

- (a) Nagar Panchayat
- (b) Municipal Council
- (c) Municipal Corporation
- (d) No option is correct

Q134. Which among the following is NOT a member of any of the two Houses of the Indian Parliament?

- I.** Prime Minister of India
 - II.** Finance Minister of India
 - III.** President of India
- (a) Only I
 - (b) Only II
 - (c) Only III
 - (d) Both II and III

Q135. Who appoints the chairman of all the parliamentary committees of Lok Sabha?

- (a) President of India
- (b) Prime Minister of India
- (c) Speaker of Lok Sabha of India
- (d) Home Minister of India

Q136. What are the minimum qualifications of a person to become a member of Lok Sabha?

- I.** Must be a citizen of India
 - II.** Must not be less than 25 years of age
 - III.** Must hold an office of profit under Union Government.
- (a) Both I and II
 - (b) Both I and III
 - (c) Both II and III
 - (d) All I, II and III

Q137. Which Article of Indian Constitution empowers Indian Parliament to amend the constitution?

- (a) Article 368
- (b) Article 252
- (c) Article 254
- (d) Article 256

Q138. The Attorney General of India is the _____ of the Government of India.

- (a) Chief Account Officer
- (b) Chief Law Officer
- (c) Chief Audit Officer
- (d) Chief Election Officer

Q139. In India, which of the following body is Constitutional in nature?

- (a) NITI Aayog
- (b) National Human Rights Commission
- (c) Central Vigilance Commission
- (d) Finance Commission

Q140. Which part of the Indian Constitution deals with Amendment of the Constitution?

- (a) Part XIV
- (b) Part XVI
- (c) Part XVIII
- (d) Part XX

Q141. Who can make laws for Union Territories on any subject under the three lists Viz. union list, state list and concurrent list?

- (a) The President of India alone
- (b) The Parliament
- (c) The Prime Minister of India
- (d) Home Minister of India

Q142. _____ is not formally prescribed device available to members of parliament.

- (a) Zero hour
- (b) Call Attention Notice
- (c) Half-an hour discussion
- (d) Short-duration discussion

Q143. Which type of city administration controls smaller urban areas?

- (a) Nagar Panchayat
- (b) Municipal Council
- (c) Municipal Corporation
- (d) No option is correct

Q144. _____ is a constitutional body in India.

- (a) Central Information Commission
- (b) Lokpal and Lokayukta
- (c) National Development Council
- (d) Election Commission

Q145. Which Constitutional Amendment Act added Part IX-A 'The Municipalities' to Indian Constitution?

- (a) 74th Constitutional Amendment Act
- (b) 42nd Constitutional Amendment Act
- (c) 39th Constitutional Amendment Act
- (d) 10th Constitutional Amendment Act

Q146. The competitive position of a company can be improved by _____.

- (a) Increasing the selling price
- (b) Reducing the margin of profit
- (c) Ignoring competitors
- (d) Understanding and fulfilling customers' needs

Q147. Deficit financing means the government borrows money from the _____.

- (a) International Monetary Fund
- (b) Ministry of Finance
- (c) Reserve Bank of India
- (d) World Trade Organization

Q148. "Global Competitiveness Report" is released by which of the following organization?

- (a) WTO
- (b) WEF
- (c) SAARC
- (d) EU

Q149. Sudden decrease of birth rate would cause _____.

- (a) increase in per capita income
- (b) increase in investment
- (c) increase in savings
- (d) increase in loan requests

Q150. In the last one decade, which one among the following sectors has attracted the highest foreign direct investment inflows into India?

- (a) Food processing
- (b) Petro-chemical
- (c) Chemicals other than fertilizers
- (d) Telecommunications

Q151. The modern economy is NOT characterized by _____.

- (a) self-sufficient village system
- (b) development of money economy
- (c) capital intensive mode of production
- (d) production for market

Q152. During which Five Year Planning was NABARD established?

- (a) Fifth
- (b) Sixth
- (c) Third
- (d) Ninth

Q153. Which among the following is NOT a 'Geographical Indicator'?

- (a) Kani Shawl
- (b) Naga Mircha
- (c) Mysore Silk
- (d) Darjeeling Basmati

Q154. The first Chairman of Disinvestment Commission was _____.

- (a) GV Ramkrishna
- (b) Madhu Dandavete
- (c) C Rangarajan
- (d) Indira Gandhi

Q155. Market imperfections of a country are reflected in _____.

- (a) Price rigidity
- (b) Factor immobility
- (c) Lack of specialization
- (d) All options are correct

Q156. China has the longest border with which of the following country?

- (a) Russia
- (b) India
- (c) Myanmar
- (d) Mongolia

Q157. Vedda is a tribe of which of the following countries?

- (a) Maldives
- (b) Myanmar
- (c) Sri Lanka
- (d) Bangladesh

Q158. Which of the following countries border touches with China?

- (a) Uzbekistan
- (b) Nepal
- (c) Philippines
- (d) South Korea

Q159. Which of the following countries border does not touch China?

- (a) Cambodia
- (b) Laos
- (c) Vietnam
- (d) Myanmar

Q160. The Equator does NOT pass through which of the following countries?

- (a) Kenya
- (b) Mexico
- (c) Indonesia
- (d) Brazil

Q161. The distance between the two latitudes is approximately _____.

- (a) 111 miles
- (b) 121 miles
- (c) 111 km
- (d) 121 km

Q162. What is Syzygy?

- (a) Position of sun, earth and moon in the straight line
- (b) Earth's position between Sun and Moon
- (c) Sun and Moon position on one side of the Earth
- (d) The right angle position of Moon from the Sun and Earth

Q163. A sector between the two longitude lines is known by which of the following name?

- (a) Belt
- (b) Gore
- (c) Timeblock
- (d) Time box

Q164. Which of the following is the largest satellite of the Solar System?

- (a) Titan
- (b) Miranda
- (c) Moon
- (d) Ganymede

Q165. What is the name of the second layer of the Earth's three concentric layers?

- (a) SIAL
- (b) SIMA
- (c) NIFE
- (d) No option is correct

Q166. The day-to-day condition of the atmosphere at a place with respect to the temperature, humidity, rainfall, windspeed, etc., is called the _____ at that place.

- (a) Climate
- (b) Ecology
- (c) Environment
- (d) Weather

Q167. The tropical region has generally a hot climate because of its location around the _____.

- (a) Poles
- (b) Southern hemisphere
- (c) High altitudes
- (d) Equator

Q168. In which of the following region midnight Sun is visible?

- (a) In Mediterranean region
- (b) In equatorial region
- (c) In Arctic area
- (d) In the east of Japan

Q169. The area of Nepal is approximately _____ square kilometres.

- (a) 115187
- (b) 128540
- (c) 135789
- (d) 147181

Q170. A cyclone is known by different names in different parts of the world. It is called a ' _____ ' in Japan and Philippines.

- (a) Funnel
- (b) Whirlpool
- (c) Twister
- (d) Typhoon

Q171. Which of the following is NOT a metamorphic rock?

- (a) Slate
- (b) Schist
- (c) Diorite
- (d) Phyllite

Q172. The swift movement of the falling water droplets along with the rising air create lightning and sound. It is this event that we call a _____.

- (a) Thunderstorm
- (b) Hailstorm
- (c) Twister
- (d) Cloudburst

Q173. Which of the following pairs is NOT correctly matched?

- (a) Silent Volcano: Damavand
- (b) Active Volcano: Stromboli
- (c) Dormant Volcano - Krakatoa
- (d) Extinct Volcano - Etna

Q174. An earthquake of magnitude 6 on Richter scale has _____ times more destructive energy than an earthquake of magnitude 4.

- (a) ten
- (b) hundred
- (c) five
- (d) thousand



Q175. Which of the following is NOT correctly matched?

- (a) Sandstone - Conglomerate
- (b) Limestone - Marble
- (c) Granite - Basalt
- (d) Gabbro - Serpentine

Q176. 1 kWh = _____ × 106 J.

- (a) 36
- (b) 3.6
- (c) 6.4
- (d) 64

Q177. Any body kept in a fluid experiences an upward force called _____.

- (a) Torque
- (b) Moment
- (c) Pressure
- (d) Upthrust

Q178. 1 watt is equal to 1 _____.

- (a) J s-1
- (b) J s
- (c) J s-2
- (d) J s2

Q179. As an object falls freely its _____.

- (a) Kinetic energy gets converted into potential energy
- (b) Potential energy gets converted into kinetic energy
- (c) Momentum gets converted into gravitational force
- (d) Gravitational force gets converted into momentum

Q180. The product of force and the time for which the force acts on a body is equal to the change in _____ of the body.

- (a) Acceleration
- (b) Torque
- (c) Momentum
- (d) Velocity

Q181. Telephone was invented in which decade?

- (a) 1670s
- (b) 1770s
- (c) 1870s
- (d) 1970s

Q182. Which device is used to limit electric current in a circuit?

- (a) Grid
- (b) Capacitor
- (c) Fuse
- (d) Resistor

Q183. In a compound the elements are always present in definite proportions by _____.

- (a) Mass
- (b) Volume
- (c) Size
- (d) No option is correct.

Q184. Which of the following statements are CORRECT?

- I.** Melamine is a Thermosetting plastic.
- II.** It resists fire.
- III.** It is a poor conductor of heat.

- (a) Only I and II
- (b) Only I and III
- (c) Only II and III
- (d) All I, II and III

Q185. Which of the following is the best fire-extinguisher?

- (a) Water
- (b) Oxygen
- (c) Carbon-dioxide
- (d) Soil

Q186. Which statements are CORRECT?

- I.** In early 1930's Nylon was prepared from coal, water and air.
- II.** Nylon was the first fully synthetic fibre.
- III.** Nylon fibre was strong, elastic and light.

- (a) Only I and II
- (b) Only I and III
- (c) Only II and III
- (d) All I, II and III

Q187. Which of the following statement is CORRECT?

- (a) Gold and Silver are not ductile
- (b) Phosphorus and Nitrogen are ductile
- (c) Copper and Platinum are ductile
- (d) Sulphur and Phosphorus are sonorous

Q188. Which of the following is man-made fibre?

- (a) Cotton
- (b) Wool
- (c) Silk
- (d) Nylon

Q189. Which of the following statement is INCORRECT regarding Sodium?

- (a) Sodium reacts vigorously with oxygen and water
- (b) A lot of heat is generated when sodium reacts with water and oxygen
- (c) It is stored in kerosene
- (d) It is a non-metal

Q190. In which part of the human body fat is completely digested?

- (a) Small Intestine
- (b) Liver
- (c) Stomach
- (d) Large Intestine

Q191. Which of the following represents the pair of sex chromosomes in men?

- (a) XY
- (b) XX
- (c) YY
- (d) No option is correct.

Q192. Scientists of which country have developed working human skeletal muscle from stem cells in the laboratory for the first time?

- (a) China
- (b) Japan
- (c) India
- (d) United States of America

Q193. The rhythmic contraction of the lining of muscles of canal to push the food along the gut is called ____.

- (a) Peristalsis
- (b) Facilitation
- (c) Guttation
- (d) No option is correct

Q194. Which of the following is a CORRECT relation of length of small intestines of an herbivore and a carnivore?

- (a) Herbivore = Carnivore
- (b) Herbivore < Carnivore
- (c) Herbivore > Carnivore
- (d) No option is correct.

Q195. Limbs of frog, lizard, bird and human are example of ____ organs.

- (a) Homogenous
- (b) Heterogeneous
- (c) Analogous
- (d) Homologous

Q196. Pepsin is an enzyme that digests ____.

- (a) Proteins
- (b) Starch
- (c) Carbohydrate
- (d) Fats

Q197. Which is the CORRECT pair of inherited chromosomes for the child to be a girl?

- (a) X from father and Y from mother
- (b) Y from father and X from mother
- (c) Y from father and Y from mother
- (d) X from father and X from mother

Q198. Gaseous exchange takes place in leaves through tiny pores for the purpose of photosynthesis. What are these pores?

- (a) Chloroplast
- (b) Stomata
- (c) Chlorophyll
- (d) Vacuole

Q199. Lymph carries digested and absorbed fat from ____.

- (a) Lungs
- (b) Intestine
- (c) Stomach
- (d) Kidney

Q200. Photosynthesis fulfills which of the following requirements of the autotrophic organisms?

- I.** Carbon
- II.** Water
- III.** Energy
- (a) Only I
- (b) Only III
- (c) I and III
- (d) All I, II and III

Q201. Which of the following information is found in Ashoka's inscriptions?

- (a) Life story
- (b) Internal policy
- (c) Foreign policy
- (d) All options are correct

Q202. Which of the following indicates the circle of the Saranath Pillar?

- (a) Law
- (b) Revolution
- (c) Progress
- (d) Religion

Q203. Harshavardhan's Vallabhi conquest is found in which of the following inscriptions?

- (a) Aihole Pillar Inscription
- (b) Junagadh Inscription
- (c) Navsari Copper plate Inscription
- (d) Damodarpur copper plate Inscription

Q204. Which of the following is not counted under sub-vedas?

- (a) Ayurveda
- (b) Yajurveda
- (c) Gandharva Veda
- (d) Shilp Veda

Q205. Which of the following was not mentioned in the Dhamma?

- (a) Obedience to parents
- (b) Charity
- (c) Paternalism
- (d) Faith in Sangha

Q206. When was Guru Nanak Dev born?

- (a) 1449 A D
- (b) 1453 AD
- (c) 1469 AD
- (d) 1499 AD

Q207. Which ruler of the Vijayanagar Empire was the friend of the Portuguese Governor Albuquerque?

- (a) Devaraya II
- (b) Narsingh Raya
- (c) Krishna Deva Rai
- (d) Venkat II

Q208. Which of the following was a major industry in the Mughal period?

- (a) Pearl production
- (b) Iron Industry
- (c) Cotton cloth
- (d) No option is correct

Q209. In which area did Nandalal Bose earn fame?

- (a) Painting
- (b) Folk Art
- (c) Dance
- (d) Politics

Q210. Where the leader of the Individual Satyagraha movement, Acharya Vinoba Bhave did started this movement?

- (a) Nashik
- (b) Poona
- (c) Pavnar
- (d) Nagpur

Q211. When did all the trade unions, except Ahmedabad Textile Labor Union, be unified?

- (a) 1930
- (b) 1928
- (c) 1932
- (d) 1933

Q212. French established their first factory at Surat and second factory at _____.

- (a) Banaras
- (b) Calcutta
- (c) Mumbai
- (d) Masulipatnam

Q213. Which of the following governor generals used to call himself as Bengal Tiger?

- (a) Lord Canning
- (b) Warren Hastings
- (c) Lord Cornwallis
- (d) Lord Wellesley

Q214. Which of the following movements was headed by Sitaram Raju?

- (a) Kuka Movement
- (b) Rampa Movement
- (c) Pabna Agitation
- (d) Bardoli Satyagraha

Q215. In which city is India's oldest European church?

- (a) Cochin
- (b) Goa
- (c) Chennai
- (d) Kolkata

Q216. Which of the following were NOT related to the Congress Socialist Party?

- (a) Acharya Narendradev
- (b) Ram Manohar Lohia
- (c) Jai Prakash Narayan
- (d) Subhash Chandra Bose

Q217. Salt March also known as Dandi March was initiated by _____.

- (a) Raja Ram Mohan Roy
- (b) Mahatma Gandhi
- (c) Avantikabai Gokhale
- (d) Kasturba Gandhi

Q218. Chauri Chaura incident took place in?

- (a) 1902
- (b) 1912
- (c) 1922
- (d) 1932

Q219. Which of the following newspapers is NOT related to Madan Mohan Malaviya?

- (a) Leader
- (b) Comrade
- (c) Hindustan
- (d) Abhyudaya

Q220. In which conference of 1888, the constitution was created for Congress?

- (a) Bombay
- (b) Calcutta
- (c) Madras
- (d) Allahabad

Q221. Which of the following decisive battles had established the dominion of the British in India?

- (a) Battle of Plassey
- (b) Battle of Buxar
- (c) Battle of Wandiwash
- (d) Third Battle of Panipat

Q222. Which of the following was the first thing that encouraged the Europeans for Indian business?

- (a) Indigo
- (b) Spice
- (c) Muslin
- (d) Cotton clothes

Q223. E.V. Ramaswamy Naicker is associated with which of the following movements?

- (a) Self-respect movement
- (b) Viacom movement
- (c) Justice movement
- (d) Ezhava movement

Q224. In which year did Vivekananda participate in the Parliament of the World's Religions?

- (a) 1893 AD
- (b) 1895 AD
- (c) 1897 AD
- (d) 1899 AD

Q225. Which of the following leaders formed 'India Home Rule Society'?

- (a) Shyamji Krishna Varma
- (b) Annie Besant
- (c) Lala Hardayal
- (d) Bal Gangadhar Tilak

Solutions

S1. Ans.(b)

Sol. Bana-Bhatt was court poet of King Harshavardhana.

S2. Ans.(b)

Sol. Nagananda (Joy of the Serpents) is a [Sanskrit play](#) attributed to king [Harshavardhana](#) (ruled 606 C.E. - 648 C.E.).

S3. Ans.(a)

Sol. Taxila was a centre of learning and is considered by some to have been one of the earliest [universities](#) in the world. It is an important archaeological site and in 1980, was declared a [UNESCO World Heritage Site](#). It was located between Indus and Jhelum.

S4. Ans.(a)

Sol. Indra is the most prominent god of 'Rig Veda'.

S5. Ans.(c)

Sol. Big landlords or warrior chiefs in the seventh century were acknowledged as Samantas by the existing kings. Samanta was a title and position used by the army people of Kings.

S6. Ans.(b)

Sol. Guru Har Krishan was the eighth of ten Gurus of the [Sikh](#) religion. Guru Har Krishan had the shortest tenure as Guru, lasting only 2 years, 5 months and 24 days. Guru Tegh Bahadur was the successor of sikh guru Har Krishan.

S7. Ans.(b)

Sol. Queen Didda was the ruler of Kashmir from 958 CE to 1003 CE, first as a Regent for her son and various grandsons, and from 980 as sole ruler and monarch.

S8. Ans.(c)

Sol. Jama Masjid of Delhi, is one of the largest mosques in India. It was built by Mughal emperor Shah Jahan between in 17th century (1644 and 1656).

S9. Ans.(b)

Sol. The Portuguese conquest of Goa occurred when the governor of Portuguese India Alfonso de Albuquerque captured the city in 1510.

S10. Ans.(d)

Sol. The first Portuguese reached India on 20 May 1498 when Vasco da Gama reached Calicut on Malabar Coast .English reached India after Portuguese.

S11. Ans.(a)

Sol. Chauth was a regular tax or tribute imposed, from early 18th century, by the Maratha Empire in India. It was an annual tax nominally levied at 25% on revenue or produce.

S12. Ans.(a)

Sol. Hyder Ali Khan was the Sultan and ruler of the Kingdom of Mysore in southern India. He offered strong resistance against the military advances of the British East India Company during the First and Second Anglo-Mysore Wars. He established a modern arsenal (1755) at Dindigul with French help.

S13. Ans.(d)

Sol. The Jacobin Club of Mysore was the first Revolutionary Republican organization to be formed in India. It was founded in 1794 by French Republican officers with the support of Tipu Sultan. He planted a Liberty Tree and declared himself Citizen Tipu.

S14. Ans.(a)

Sol. Tipu Sultan was a ruler of the Kingdom of Mysore. He was the eldest son of Sultan Haidar Ali of Mysore. Tipu introduced a number of administrative innovations during his rule, including his coinage, a new lunar-solar calendar, and a new land revenue system which initiated the growth of the Mysore silk industry.

S15. Ans.(c)

Sol. The Modi script had been employed in the documents of the Marathas. This script is used to write Maratha Language.

S16. Ans.(c)

Sol. Atmiya Sabha was a philosophical association. The association was started by Ram Mohan Roy in 1815 in Kolkata. They used to conduct debate and discussion sessions on philosophical topics, and also used to promote free and collective thinking and social reform.

S17. Ans.(b)

Sol. Raja Rammohan Roy and David Hare were associated with the foundation of the Hindu college.

S18. Ans.(b)

Sol. Dayanand Saraswati was a Hindu religious leader and founder of the Arya Samaj, a Hindu reform movements of the Vedic tradition. He was also a renowned scholar of the Vedic lore and Sanskrit language.

S19. Ans.(b)

Sol. Satyashodhak Samaj is a social reform Society founded by Jyotirao Phule in Pune, India, on 24 September 1873. Its purpose was to liberate the Shudra and Untouchable castes from exploitation and oppression.

S20. Ans.(c)

Sol. Jyotirao Govindrao Phule was an Indian social activist for the Dalit people, a thinker, anti-caste social reformer and writer from Maharashtra. Satyashodhak Samaj is a social reform society founded by Jyotirao Phule in Pune, India, on 24 September 1873. Its purpose was to liberate the Shudra and Untouchable castes from exploitation and oppression.

S21. Ans.(b)

Sol. Arya Samaj is an Indian Hindu reform movement that promotes values and practices based on the belief in the infallible authority of the Vedas. The Samaj was founded by the Dayananda Saraswati on 7 April 1875. Members of the Arya Samaj believe in one God and reject the worship of idols.

S22. Ans.(a)

Sol. Government of India Act, 1858 provided that India was to be governed directly and in the name of the crown. This act abolished the company rule, abolished the Court of directors and abolished the Board of control. The act provided the Crown will govern India directly through a Secretary of State for India, who was to exercise the powers which were being enjoyed by the Court of Directors and Board of control.

S23. Ans.(b)

Sol. The strength of the Council was gradually enlarged by subsequent acts. Under the Indian Councils Act of 1892, the maximum strength of the Council was raised to 20 out of which seven were to be elected. The Indian Councils Act of 1909 further raised the number of members of the Council to 50.

S24. Ans.(d)

Sol. The Indian Councils Act 1909 is also known as the Minto-Morley Reforms was passed by British Parliament in 1909 in an attempt to widen the scope of legislative councils, placate the demands of moderates in Indian National Congress and to increase the participation of Indians the governance.

S25. Ans.(b)

Sol. Charter Act of 1813, was an Act of the Parliament of the United Kingdom which renewed the charter issued to the British East India Company, and continued the Company's rule in India. However, the Company's commercial monopoly was ended, except for the tea trade and the trade with China.

S26. Ans.(b)

Sol. Lord Wellesley remained Governor General of Fort Williams from 1798 to 1805. The subsidiary Alliance is a policy started by Lord Wellesley. The Subsidiary Alliance System was a Treaty between the company and the Indian native rulers. In return for a payment or subsidy, the company would place garrison troops in that ruler's territory to fight against their enemies.

S27. Ans.(b)

Sol. Sir William Hutt Curzon Wylie, was an Indian army officer, and later an official of the British Indian Government. He was assassinated in London on the evening of 1 July 1909 by Madan Lal Dhingra at the Imperial Institute.

S28. Ans.(c)

Sol. The civil services were reformed and modernised by Lord Cornwallis and hence he is called the "Father of Indian Civil Service".

S29. Ans.(a)

Sol. Ashwini Kumar Dutta was a Bengali educationist, philanthropist, social reformer and patriot. The Partition of Bengal drew him to the Swadeshi movement. He founded the Swadesh Bandhab Samiti to promote the consumption of indigenous products and boycott foreign goods.

S30. Ans.(c)

Sol. In 1867, Dadabhai Naoroji put forward the 'drain of wealth' theory in which he stated that the Britain was completely draining India. He mentioned this theory in his book Poverty and Un-British Rule in India.

S31. Ans.(b)

Sol. The Gram sabha is a key factor in making the Gram Panchayat play its role and to be responsible. The Gram Sabha is a meeting of all adults who live in the area covered by the Panchayat. Anyone living in the area, who is an adult, that is 18 years old or more, is a member of Gram Sabha.

S32. Ans.(d)

Sol. There are three level of Government in India

- I. Local level government
- II. State level government
- III. National level government.

S33. Ans.(b)

Sol. The Panchs and the Gram Panchayat are answerable to the Gram Sabha who elected them. The idea of people's participation in the Panchayati Raj System extends to two other levels. One is the Block level, which is called the Janpad Panchayat or the Panchayat Samiti. The Panchayat Samiti has many Gram Panchayats under it.

S34. Ans.(b)

Sol. The Executives refers to a smaller group of people who are responsible for implementing laws and running the government.

S35. Ans.(a)

Sol. The first fascist movements emerged in Italy during World War I before it spread to other European countries.

S36. Ans.(a)

Sol. Separation of powers is a political doctrine originating in the writings of Charles de Secondat, Baron de Montesquieu in The Spirit of the Laws, in which he argued for a constitutional government with three separate branches, each of which would have defined abilities to check the powers of the others.

S37. Ans.(b)

Sol. There are three main organs of the Government in State i.e. legislature, executive and judiciary. According to the theory of separation of powers, these three powers and functions of the Government must, in a free democracy, always be kept separate and exercised by separate organs of the Government

S38. Ans.(a)

Sol. Gram Sabha prevents the Panchayat from doing wrong things like misusing money or favouring certain people. Gram Sabha means a body consisting of all persons whose names are included in the electoral rolls for the Panchayat at the village level.

S39. Ans.(c)

Sol. Three levels of governments are present in India: the central government, the state government and the local bodies (Municipal corporations and panchayats). The powers are distributed among these three levels of the government to easily manage the administration of the country.

S40. Ans.(c)

Sol. The States Reorganisation Act, 1956 was a major reform of the boundaries of India's states and territories, organising them along linguistic lines.

S41. Ans.(c)

Sol. In June 1948, the Government of India appointed the Linguistic Provinces Commission under the chairmanship of S K Dhar to examine the feasibility of this. The commission submitted its report in December 1948 and recommended the reorganisation of states on the basis of administrative convenience rather than linguistic factor.

S42. Ans.(b)

Sol. JVP is full name of committee members. They are Jawaharlal Nehru, Vallabhbhai Patel, Pattabhi Sitaramayya. It was setup in 1949. This committee also rejected the linguistic factor of reorganization of the states. This committee recommended the reorganization of States on the basis of security, unity and economic prosperity of the nation.

S43. Ans.(a)

Sol. States Reorganisation Commission consisted of Fazal Ali, K. M. Panikkar and H. N. Kunzru. Some of its recommendations were implemented in the States Reorganisation Act of 1956.

S44. Ans.(a)

Sol. The States Reorganisation Commission (SRC) was a body constituted by the Central Government of India in 1953 to recommend the reorganisation of state boundaries. States Reorganisation Commission consisted of Fazal Ali, K. M. Panikkar and H. N. Kunzru. Some of its recommendations were implemented in the States Reorganisation Act of 1956.

S45. Ans.(b)

Sol. The States Reorganization Act was passed by parliament in November 1956. It provided for fourteen states and six centrally administered territories.

S46. Ans.(b)

Sol. After fifth year plan Rolling plan is introduced.

S47. Ans.(b)

Sol. Indirect Tax causes heavy burden on the poorer sections of society.

S48. Ans.(d)

Sol. In economics, the Lorenz curve is a graphical representation of the distribution of income or of wealth.

S49. Ans.(c)

Sol. An Isoquant Curve shows all the possible combinations of input factors that yield the same quantity of production. In other words, an iso-quant curve is a geometric representation of the production function, wherein different combinations of labor and capital are employed to have the same level of output.

S50. Ans.(c)

Sol. A price signal is information conveyed to consumers and producers, via the price charged for a product or service, which provides a signal to increase or decrease supply or demand. In other words, in a market system, the central problems regarding how much and what to produce are solved through the coordination of economic activities brought about by Price signals.

S51. Ans.(b)

Sol. Law of variable proportions says that the marginal product of a factor input initially rises with its employment level. But after reaching a certain level of employment, it starts falling.

S52. Ans.(b)

Sol. Dadabhai Naoroji was the first to calculate the national income in India in 1868 .

S53. Ans.(c)

Sol. Price and output sold relationship is explained through the supply function.

S54. Ans.(a)

Sol. This theory has been given by JM Keynes.



S55. Ans.(a)

Sol. Special Economic Zone (SEZ) concept was first introduced in China in the 1980s. The most successful SEZ in China, Sherizhen, has developed from a small village into a city with a population over 10 million within 20 years. Commerce Minister Mr Maran Had introduced SEZ concept in year 1997 for first times in India.

S56. Ans.(a)

Sol. The Montreal Protocol is an international treaty on Substances that Deplete the Ozone. Monetreal protocol gradually eliminate the production and consumption of ozone depleting substances to limit their damage to the earth's ozone layer. Chlorofluro carbon is one of the Ozone depleting substance.

S57. Ans.(b)

Sol. Russia is the leading producer of Asbestos

S58. Ans.(a)

Sol. The Great Barrier Reef is the world's largest coral reef system. The reef is located in the Coral Sea, off the coast of Queensland, Australia in Pacific Ocean.

S59. Ans.(a)

Sol. The smallest island country in the Indian Ocean is Maldives.

S60. Ans.(b)

Sol. London is the largest metal trading centre.

S61. Ans.(b)

Sol. Jharkhand has the largest number of host trees and ranks first in the country for production of Lac.

S62. Ans.(c)

Sol. The Central Deccan Plateau dry deciduous forests in India are an integral part of the Deccan Plateau that is a large triangular plateau, situated in southern India and sandalwood is a special feature of deccan plateau.

S63. Ans.(b)

Sol. Bandhavgarh National Park is one of the wild life sanctuaries in the Indian state Madhya Pradesh. Bandhavgarh was declared a national park in 1968. The density of the tiger population at Bandhavgarh is one of the highest known in India.

S64. Ans.(a)

Sol. Nainital famously referred to as the 'Lake District of India'.

S65. Ans.(b)

Sol. Two types of cloud which are Nimbostratus and Cumulonimbus are mainly rain bearing clouds.

S66. Ans.(d)

Sol. Hachure is the short lines used on maps to shade or to indicate slopes and their degree and direction.

S67. Ans.(c)

Sol. Sleet is the Precipitation that falls to earth in the form of frozen or partially frozen raindrops, often when the temperature is near the freezing point. In other words, Precipitation in the form of a mixture of rain and snow is called Sleet

S68. Ans.(b)

Sol. Kaziranga National Park situated in Assam state of India, is a UNESCO world heritage sites of India and known for Great Indian one horned Rhinoceros. Kaziranga also boasts the highest density of tigers among the protected areas in the world and was declared a Tiger Reserve in 2006.

S69. Ans.(d)

Sol. Three crops that contribute maximum to global food grain production are Wheat, rice, maize.

S70. Ans.(b)

Sol. 'Harmattan' winds that flow in Africa are known as doctor winds as these winds are dry and help in reducing the level of humidity.

S71. Ans.(b)

Sol. Sirius is also known as the Dog Star. It is the brightest star outside our Solar System.

S72. Ans.(c)

Sol. Pagladia dam is situated in state of Assam.

S73. Ans.(c)

Sol. Gir Kesar which recently got GI tag is a famous variety of mango.

S74. Ans.(d)

Sol. A point source of pollution is a single identifiable source of air, water, thermal, noise or light pollution. Oil refinery waste water, noise from Jet engine and Air pollution from forest fire are examples of point source of pollution.

S75. Ans.(b)

Sol. Tuirial dam is an earth fill and gravity dam. Prime minister Narendra Modi inaugrated the 60MW Tuirial hydropower project in Aizawal, Mizoram on 16th December 2017.

S76. Ans.(d)

Sol. Newton's law of gravitation states that the gravitational force between two point like objects is directly proportional to the product of their masses and inversely proportional to the square of the distance between them.

S77. Ans.(c)

Sol. Force=mass X acceleration
Acceleration=Force/mass
=20/10
=2m/s².

S78. Ans.(a)

Sol. The product of mass of a body and the acceleration produced in it equals to the acting on it force.

S79. Ans.(b)

Sol. The kinetic energy is the energy in moving objects or mass. The kinetic energy of the wind (wind energy) can be converted into electrical or mechanical energy.

S80. Ans.(a)

Sol. The conversion of light energy into electrical energy is based on the phenomenon called photovoltaic effect. Silicon is most widely used semiconductor material for construction photovoltaic cell.

S81. Ans.(c)

Sol. CO₂ extinguisher work by replacing the oxygen surrounding the flames with carbon dioxide, meaning the fire can no longer burn. Hence it is best fire extinguisher.

S82. Ans.(d)

Sol. In early 1930's Nylon was prepared from coal, water and air. Nylon was the first fully synthetic fibre. Nylon fibre was strong, elastic and light. Nylon is a synthetic plastic material composed of polyamides of high molecular weight and usually, but not always, manufactured as a fibre.

S83. Ans.(c)

Sol. Gold and Silver are most ductile metals. Phosphorus and Nitrogen are non-ductile. Sulphur and phosphorus are non-sonorous. Copper and platinum are also ductile metals.

S84. Ans.(d)

Sol. Sphalerite is the chief ore of Zinc.

S85. Ans.(d)

Sol. Hydralazine is used to cure high blood pressure (hypertension).

S86. Ans.(a)

Sol. Males typically have two different kinds of sex chromosomes (XY), and are called the heterogametic sex.

S87. Ans.(d)

Sol. Scientists from Duke University in North Carolina, US for first time have developed working human skeletal muscle from stem cells in the laboratory.

S88. Ans.(a)

Sol. Peristalsis is a particular, wave-like kind of muscle contraction because its purpose is to move solids or liquids along within the tube-like structures of the digestive and urinary.

S89. Ans.(c)

Sol. End products of digestion of carbohydrates are Glucose, fructose and galactose.

S90. Ans.(d)

Sol. Salivary gland is a source of enzyme Ptyalin. The enzyme ptyalin, or salivary amylase acts on starches and converts them to maltose. It helps in the predigestion of starches

S91. Ans.(b)

Sol. From Newton's first equation of motion,

$$v = u + at$$

$$\text{So, } a = (v - u) / t = (25 - 15) / 5$$

$$a = 2 \text{ m/s}^2$$

$$\text{Now } F = ma$$

$$= 4 \times 2 = 8 \text{ m/s}^2 .$$

S92. Ans.(d)

Sol. During uniform motion of an object along a straight line, the change in velocity of the object for any time interval is zero.

S93. Ans.(c)

Sol. According to Ohm's law,

$$V = IR$$

Where V is voltage, I is the current in the circuit and R is the resistance of an electrical component

$$R = V / I = 5 / 0.1$$

$$= 50.$$

S94. Ans.(b)

Sol. The motion of a freely falling body is an example of Uniformly accelerated motion.

S95. Ans.(a)

Sol. We know that

$$\text{Resistance, } R = \rho(l/A)$$

Where ρ is the resistivity, l is the length of wire and A is the cross-sectional area

$$R = 200 \times 20 / 100$$

$$= 40 \text{ ohm.}$$

S96. Ans.(c)

Sol. Metals conduct electricity because they have "free electrons." Unlike most other forms of matter, metallic bonding is unique because the electrons are not bound to a particular atom. This allows the delocalized electrons to flow in response to a potential difference.

S97. Ans.(c)

Sol. The ozone layer or ozone shield is a region of Earth's stratosphere that absorbs most of the Sun's ultraviolet (UV) radiation. Stratosphere contains high concentrations of ozone (O₃) in relation to other parts of the atmosphere.

S98. Ans.(c)

Sol. Modern bulletproof vests are predominantly made out of dozens of layers of tightly woven material, predominantly Kevlar. The layers are sealed together into a vest-shaped sheet to protect the wearer's organs.

S99. Ans.(c)

Sol. Manganite, an ore mineral of manganese, basic manganese oxide [MnO(OH)] that forms dark gray to black crystal bundles or fibrous masses.

S100. Ans.(c)

Sol. Pentane (C₅H₁₂) has three structural isomers. N-pentane, 2-methylbutane, and 2-ethylpropane are three structural isomers of pentane.

S101. Ans.(d)

Sol. The Chola dynasty was one of the longest-ruling dynasties in the history of southern India.

S102. Ans.(a)

Sol. Group of Monuments at Hampi are a UNESCO World Heritage Site located in east-central Karnataka, India. It was built by Harihara and Bukka.

S103. Ans.(c)

Sol. According to the categories of land mentioned in the Chola inscriptions, Shalabhoga was known as the land for the maintenance of schools.

S104. Ans.(b)

Sol. The Stone Age people were mostly food gatherers and hunters and they use to wear leaves, bark of trees and skin of animals.

S105. Ans.(c)

Sol. The domestication of animals is the mutual relationship between animals with the humans who have influence on their care and reproduction. The first domesticated animal by primitive man was dog.

S106. Ans.(d)

Sol. Genghis Khan, founder of the Mongol Empire, invaded Transoxiana in 1219 in north-east during his conquest of Khwarezm.

S107. Ans.(b)

Sol. On 30th August 1659, Mughal Emperor Shah Jahan's son Dara Shikoh was put to death by his younger brother Aurangzeb.

S108. Ans.(a)

Sol. Kitab-al-hind is the Arabic work of Al-Biruni.

S109. Ans.(a)

Sol. The European planters at Champaran in Gujarat practised illegal methods of indigo cultivation and forced the Indian peasants to cultivate Indigo on 3/20th part of their land holding. This was called Tinkathia system. Peasants of Champaran with the help of Gandhi and Rajendra Prasad organised Satyagraha and led to abolition of Tinkathia system.

S110. Ans.(c)

Sol. Merger of Mysore is not credited to Lord Dalhousie.

S111. Ans.(d)

Sol. Hunter Education Commission was founded in 1882 by Lord Ripon (1880-1884 AD) during the British rule. The government appointed the commission under the chairmanship of William Wilson Hunter to review the progress made in the field of education by Charles Wood's Declaration. This commission is not formed during the Lord Curzon.

S112. Ans.(a)

Sol. British India's first telegraph line and office was opened in October 1851, between Calcutta and Diamond Harbour along the busy shipping route on the Hooghly. By March 1854, there were 800 miles of telegraph lines between Calcutta and Agra.

S113. Ans.(b)

Sol. The Non-Cooperation movement was launched formally on 1 August, 1920 and on February 12, 1922, a Congress meeting in Bardoli was announced to end the Non-Cooperation Movement.

S114. Ans.(c)

Sol. The Battle of Buxar was fought on 22 October 1764 between the forces under the command of the British East India Company led by Hector Munro and the combined armies of Mir Qasim, Nawab of Bengal till 1763; the Nawab of Awadh; and the Mughal Emperor Shah Alam II.

S115. Ans.(d)

Sol. Baghera Rebellion did NOT happen in the area of Bengal.

S116. Ans.(c)

Sol. Zaman Shah gave the title of Raja to Ranjit Singh.

S117. Ans.(a)

Sol. For the first time in India, the Kisan Diwas was celebrated in 1936.

S118. Ans.(d)

Sol. Karsandas Mulji was an Indian journalist, writer and social reformer from Gujarat. He became a vernacular schoolmaster and started a weekly paper in Gujarati called Satya Prakash.

S119. Ans.(c)

Sol. In late November 1928 the WPP of Bengal executive committee met with Philip Spratt and Muzaffar Ahmed. They decided to appoint Sohan Singh Josh of the Punjab Kirti Kisan Party to chair the All India Workers and Peasants Conference, to be held in Calcutta in December.

S120. Ans.(d)

Sol. To conclude a peace treaty with Ranjit Singh, the Governor General Lord Minto sent Metcalfe to negotiate with him as a result of treaty of Amritsar.

S121. Ans.(a)

Sol. The famous Cossijurah Case of Bengal happened in the reign of Warren Hastings in 1779-1780.

S122. Ans.(b)

Sol. The first clearly registered trade-union is considered to be the Madras Labour Union founded by B.P. Wadia in 1918.

S123. Ans.(c)

Sol. Robert Bulwer-Lytton was an English statesman and poet (under the pen name Owen Meredith). He served as Viceroy of India between 1876 and 1880, during which time Queen Victoria was proclaimed Empress of India. When Lytton was twenty-five years old, he published in London a volume of poems under the name of Owen Meredith.

S124. Ans.(d)

Sol. The per capita income in India was Rs. 20/- in 1867-68, was ascertained for the first time by Dadabhai Naoroji.

S125. Ans.(b)

Sol. Lord Lytton remained the Viceroy of India from 1876-1880. Second Afghan war- 1878-80, Vernacular Press Act-1878 and Arms act- 1878 were important features of the Lord Lytton viceroyalty.

S126. Ans.(d)

Sol. Chuar Rebellion occurred in 1798-99 in Bankura / Midnapore districts of modern West Bengal. Munda rebellion took place in the region south of Ranchi in 1899-1900. Santhal Revolt took place in 1855. The Vellore mutiny on 10 July 1806 was the first instance of a large-scale and violent mutiny by Indian sepoys against the East India Company.

S127. Ans.(b)

Sol. The East India Association was founded by Dadabhai Naoroji in 1866, in collaboration with Indians and retired British officials in London. It superseded the London Indian Society and was a platform for discussing matters and ideas about India, and to provide representation for Indians to the Government.

S128. Ans.(d)

Sol. Sardar Patel is NOT associated with Champaran Satyagraha.

S129. Ans.(b)

Sol. In 1856 AD years sea travel has been made mandatory for Indian soldiers.

S130. Ans.(b)

Sol. The Indian Council of 1892 Act was based on Dufferin Plan. The Viceroy at the time Lord Dufferin set up a committee to look into the matter. But the Secretary of State did not agree to the plan of direct elections. He, however, agreed to representation by way of indirect election.

S131. Ans.(d)

Sol. The Anti-Defection Law was passed in 1985 through the 52nd Amendment to the Constitution, which added the Tenth Schedule to the Indian Constitution.

S132. Ans.(c)

Sol. Article 32 provides a fundamental right to each person in India to approach Supreme Court of India for enforcement of the fundamental rights enshrined in Part III of the Constitution. Basically, one can seek an order from Supreme Court which shall be binding on everyone to protect their fundamental right.

S133. Ans.(a)

Sol. A nagar panchayat or Notified Area Council (NAC) or City Council in India is a settlement in transition from rural to urban. The 74th Amendment made provisions relating to urban local government. The three-tier structure is municipal corporation, municipal council and nagar panchayat.

S134. Ans.(c)

Sol. The Parliament is composed of the President of India and the houses. It is a bicameral legislature with two houses: the Rajya Sabha (Council of States) and the Lok Sabha (House of the People). But President is not a member of any of two houses of Parliament.

S135. Ans.(c)

Sol. If the speaker or presiding officer himself is a member of the committee then he becomes the Chairman. If he is not a member but his deputy is, then later is appointed as chairman.

S136. Ans.(a)

Sol. The minimum qualifications of a person to become a member of Lok Sabha - Must be a citizen of India, Must not be less than 25 years of age and not hold an office of profit under Union Government.

S137. Ans.(a)

Sol. Article 368 of the Constitution of India grants constituent power to make formal amendments and empowers Parliament to amend the Constitution by way of addition, variation or repeal of any provision according to the procedure laid down therein, which is different from the procedure for ordinary legislation.

S138. Ans.(b)

Sol. The Attorney General for India is the Indian government's chief legal advisor, and is primary lawyer in the Supreme Court of India.

S139. Ans.(d)

Sol. Constitutional bodies are the bodies which are mentioned under the constitution of India in order to run the government, and any change in these bodies needs an amendment in constitution via passing constitutional amendment bill in the parliament. Finance Commission is a constitutional body.

S140. Ans.(d)

Sol. Amending the Constitution of India is the process of making changes in the supreme law of land. The procedure of amendment in the constitution is laid down in Part XX (Article 368) of the Constitution of India.

S141. Ans.(b)

Sol. The Parliament can make laws for Union Territories on any subject under the three lists Viz. union list, state list and concurrent list.

S142. Ans.(a)

Sol. The time immediately following the Question Hour has come to be known as "Zero Hour". It starts at around 12 noon (hence the name) and members can, with prior notice to the Speaker, raise issues of importance during this time.

S143. Ans.(b)

Sol. Nagar Nigam, also known as a Municipal Corporation, is a local governing body which has a population of more than one million. Nagar Palika, also known as a Municipality or municipal council, is an urban local body that administers to a city with a population of 10,000 to 30,000.

S144. Ans.(d)

Sol. The Election Commission of India is an autonomous constitutional authority responsible for administering election processes in India.

S145. Ans.(a)

Sol. The Constitution (Seventy Fourth Amendment) Act, 1992 has introduced a new Part IXA in the Constitution, which deals with Municipalities in an article 243 P to 243 ZG. This amendment, also known as Nagarpalika Act, came into force on 1st June 1993.

S146. Ans.(d)

Sol. To improve your competitive positioning is to view your business from four different axes—supply chain, R&D and innovation, manufacturing, and marketing and sales i.e. fulfilling and understanding customer needs.

S147. Ans.(c)

Sol. Deficit financing is a method of meeting government deficits through the creation of new money. When the Government resorts to deficit financing, it usually borrows from the Reserve Bank of India.

S148. Ans.(b)

Sol. The Global Competitiveness Report (GCR) is a yearly report published by the World Economic Forum (WEF).

S149. Ans.(a)

Sol. Sudden decrease of birth rate would increase in per capita income. Per capita Income is calculated by taking a measure of all sources of income in the aggregate and dividing it by the total population.

S150. Ans.(d)

Sol. The telecommunications sector constituted for the largest part in foreign direct investment equity inflows in India with an overall amount of 6.14 billion U.S. dollars for FY 2018.

S151. Ans.(a)

Sol. The modern economy is not characterized by self-sufficient village system.

S152. Ans.(b)

Sol. NABARD was established on the recommendations of B.Sivaraman Committee, (by Act 61, 1981 of Parliament) on 12 July 1982 to implement the National Bank for Agriculture and Rural Development Act 1981. It was established during Sixth five year plan.

S153. Ans.(d)

Sol. A geographical indication (GI) is a sign used on products that have a specific geographical origin and possess qualities or a reputation that are due to that origin. Naga mircha, Mysore silk and Kashmir shawl are in the GI list while Darjeeling Basmati is not in GI list.

S154. Ans.(a)

Sol. The first Chairman of Disinvestment Commission was GV Ramkrishna

S155. Ans.(d)

Sol. An imperfect market refers to any economic market that does not meet the rigorous standards of a hypothetical perfectly (or "purely") competitive market. Market imperfections of a country are reflected in Price rigidity, Factor immobility & Lack of specialization.

S156. Ans.(d)

Sol. Mongolia shares the longest land border with China.

S157. Ans.(c)

Sol. The Vedda are a minority indigenous group of people in Sri Lanka who, among other self-identified native communities such as Coast Veddas, Anuradhapura Veddas and Bintenne Veddas, are accorded indigenous status.

S158. Ans.(b)

Sol. China has the maximum number of neighbours touching its border. The 14 countries touching its border are: India, Pakistan, Afghanistan, Tajikistan, Kyrgyzstan, Kazakhstan, Mongolia, Russia, North Korea, Vietnam, Laos, Myanmar, Bhutan and Nepal

S159. Ans.(a)

Sol. China has the maximum number of neighbours touching its border. The 14 countries touching its border are: India, Pakistan, Afghanistan, Tajikistan, Kyrgyzstan, Kazakhstan, Mongolia, Russia, North Korea, Vietnam, Laos, Myanmar, Bhutan and Nepal.

S160. Ans.(b)

Sol. The equator passes through 13 countries: Ecuador, Colombia, Brazil, Sao Tome & Principe, Gabon, Republic of the Congo, Democratic Republic of the Congo, Uganda, Kenya, Somalia, Maldives, Indonesia and Kiribati.

S161. Ans.(c)

Sol. Latitude is the angular distance north or south from the equator of a point on the earth's surface, measured on the meridian of the point. Each degree of latitude is approximately 69 miles (111 kilometers)

S162. Ans.(a)

Sol. The word syzygy is an astronomical term that refers to an alignment in a straight line of three celestial bodies like sun, moon and earth bound by gravity.

S163. Ans.(b)

Sol. A gore is the curved surface which lies between two close lines of longitude on a globe. It refers to a sector of a curved surface.

S164. Ans.(d)

Sol. Ganymede is a satellite of Jupiter and the largest satellite in our solar system. It is larger than Mercury and Pluto and three-quarters the size of Mars.

S165. Ans.(b)

Sol. The continents are composed of lighter silicates—silica + aluminium (also called 'sial') while the oceans have the heavier silicates—silica + magnesium (also called 'sima'). It is composed of nickel and iron. Sima is name of the second layer of the Earth's three concentric layers.

S166. Ans.(d)

Sol. Weather is described in terms of variable conditions such as temperature, humidity, wind velocity, precipitation, and barometric pressure. The average weather conditions of a region over time are used to define a region's climate.

S167. Ans.(d)

Sol. The tropical region has generally a hot climate because of its location around the Equator.

S168. Ans.(c)

Sol. The midnight sun is a natural phenomenon that occurs in the summer months in places north of the Arctic Circle or south of the Antarctic Circle, when the sun remains visible at the local midnight.

S169. Ans.(d)

Sol. Area of Nepal is approximately 147,181 km².

S170. Ans.(d)

Sol. Cyclones is called Typhoons in Japan and Philippines. A typhoon is a tropical cyclone that develops between 180° and 100°E in the Northern Hemisphere. This region is referred to as the Northwestern Pacific Basin.

S171. Ans.(c)

Sol. Metamorphic rocks arise from the transformation of existing rock types, in a process called metamorphism, which means "change in form". Some examples of metamorphic rocks are gneiss, slate, marble, schist, phyllite and quartzite.

S172. Ans.(a)

Sol. The swift movement of the falling water droplets along with the rising air create lightning and sound. It is this event that we call a Thunderstorm.

S173. Ans.(d)

Sol. An extinct volcano is one which is no longer active and hasn't erupted in historical times. Some volcanoes lie dormant for thousands of years before erupting again. Etna is one of the most active volcanoes in the world.

S174. Ans.(d)

Sol. The original Richter scale, 4 to 6 or from 5 to 7, corresponds to about 1000 times the energy release.

S175. Ans.(a)

Sol. Metamorphic rocks are the rocks formed from other rocks. They are sedimentary or igneous rocks that have undergone changes as a result of extreme pressure and heat. Marble is produced by the metamorphism of Limestone. Basalt is produced by the metamorphism Granite. Serpentine is produced by the metamorphism of Gabbro. But Conglomerate is a coarse-grained clastic sedimentary rock.

S176. Ans.(b)

Sol. 1 kWh = 3.6×10⁶ J.

S177. Ans.(d)

Sol. The upward force exerted by the water on the bottle is known as upthrust or buoyant force. In fact, all objects experience a force of buoyancy when they are immersed in a fluid.

S178. Ans.(a)

Sol. 1 Watt is defined as 1 Joule per second.

S179. Ans.(b)

Sol. Before the object begins falling, it has gravitational potential energy which can be calculated by mgh, So the initial potential energy will equal the kinetic energy of the object right before it hits the ground. The potential energy has been converted into kinetic energy.

S180. Ans.(c)

Sol. The product of force and the time for which the force acts on a body is equal to the change in momentum of the body.

S181. Ans.(c)

Sol. The first successful bi-directional transmission of clear speech by Bell and Watson was made on March 10, 1876.

S182. Ans.(d)

Sol. The charge passing through the circuit always passes through an appliance (which acts as a resistor) or through another resistor, which limits the amount of current that can flow through a circuit.

S183. Ans.(a)

Sol. According to Law of Definite Proportion- "In a chemical substance the elements are always present in definite proportions by mass".

S184. Ans.(d)

Sol. Melamine resin or melamine formaldehyde is a hard, thermosetting plastic material. It has low thermal conductivity. Melamine shows excellent flame retardant properties and thus a bad conductor of heat.

S185. Ans.(c)

Sol. CO₂ extinguisher work by replacing the oxygen surrounding the flames with carbon dioxide, meaning the fire can no longer burn. Hence it is best fire extinguisher.

S186. Ans.(d)

Sol. In early 1930's Nylon was prepared from coal, water and air. Nylon was the first fully synthetic fibre. Nylon fibre was strong, elastic and light. Nylon is a synthetic plastic material composed of polyamides of high molecular weight and usually, but not always, manufactured as a fibre.

S187. Ans.(c)

Sol. Gold and Silver are most ductile metals. Phosphorus and Nitrogen are non-ductile. Sulphur and phosphorus are non-sonorous. Copper and platinum are also ductile metals.

S188. Ans.(d)

Sol. All except Nylon are natural fibres while Nylon is a man-made polymer.

S189. Ans.(d)

Sol. Sodium is an alkali metal. It reacts quickly with water and oxygen and produces a lot of heat when it reacts with water and oxygen. So, it is kept in kerosene oil.

S190. Ans.(a)

Sol. Digestion of some fats can begin in the mouth where lingual lipase breaks down some short chain lipids into diglycerides. However fats are mainly digested in the small intestine.

S191. Ans.(a)

Sol. Males typically have two different kinds of sex chromosomes (XY), and are called the heterogametic sex.

S192. Ans.(d)

Sol. Scientists from Duke University in North Carolina, US for first time have developed working human skeletal muscle from stem cells in the laboratory.

S193. Ans.(a)

Sol. Peristalsis is a particular, wave-like kind of muscle contraction because its purpose is to move solids or liquids along within the tube-like structures of the digestive and urinary tracts.

S194. Ans.(c)

Sol. The length of small intestine differs in various animals depending on their food that they eat. Herbivores need a longer small intestine to allow cellulose to be digested as taken from green plants. Meat is easier to digest, hence carnivores like tiger have a shorter small intestine.

S195. Ans.(d)

Sol. A homologous structure is an organ, system, or body part that shares a common ancestry in multiple organisms. Limbs of frog, lizard, bird and human are example of Homologous organs.

S196. Ans.(a)

Sol. Pepsin is an endopeptidase that breaks down proteins into smaller peptides (protease). It is produced in the stomach and is one of the main digestive enzymes in the digestive systems of humans and many other animals, where it helps digest the proteins in food.

S197. Ans.(d)

Sol. An X chromosome combines with the mother's X chromosome to make a baby girl (XX) and a Y chromosome will combine with the mother's to make a boy (XY).

S198. Ans.(b)

Sol. Stomata are the microscopic openings or pores in the epidermis of leaves and young stems. Stomata are generally more numerous on the underside of leaves. They provide for the exchange of gases between the outside air and the branched system of interconnecting air canals within the leaf.

S199. Ans.(b)

Sol. Lymphatic vessels present in the intestinal villi absorb fatty acids and carries the digested food and fats from the small intestine. It acts as a reservoir of digested food and water.

S200. Ans.(c)

Sol. Most autotrophs use a process called photosynthesis to make their food. In photosynthesis, autotrophs use energy from the sun to convert water from the soil and carbon dioxide from the air into a nutrient called glucose. Glucose is a type of sugar. The glucose gives plants energy.

S201. Ans.(d)

Sol. The Edicts of Ashoka are in total 33 inscriptions written on the Pillars, boulders and cave walls of Mauryan Period, during the reign of the Emperor Ashok that are dispersed throughout the Indian Sub-continent covering India, Pakistan and Nepal. Information related to life story of Ashoka, Internal Policy and Foreign policy was found in inscriptions.

S202. Ans.(c)

Sol. The wheel (circle) in Sarnath Pillar indicates Progress.

S203. Ans.(c)

Sol. Harshavardhan's Vallabhi conquest is found in Navsari Copper Plate inscription.

S204. Ans.(b)

Sol. The Yajur Veda is one of the oldest books in the Vedas. Yajurveda is not counted among sub-vedas.

S205. Ans.(d)

Sol. Ashoka through his Dhamma established the ideal of paternal kingship. Through his edicts, he said everybody should serve parents, revere teachers, and practice ahimsa and truthfulness and Charity.

S206. Ans.(c)

Sol. Sri Guru Nanak Dev was born in 1469 in Talwandi, a village in the Sheikhpura district, 65 kms. west of Lahore. His father was a village official in the local revenue administration. As a boy, Sri Guru Nanak learnt, besides the regional languages, Persian and Arabic.

S207. Ans.(c)

Sol. Afonso de Albuquerque was the second governor of the Portuguese India and is known as founder of Portuguese colonial empire in India. Krishna Deva Rai was the friend of the Portuguese Governor Albuquerque.

S208 Ans.(c)

Sol. Cotton and silk were the main textile crops during the medieval period. The cotton textile industry contributed a lot to the development of the economy of Mughal Empire.

S209. Ans.(a)

Sol. Nandalal Bose related to Painting.

S210. Ans.(c)

Sol. The leader of the Individual Satyagraha movement, Acharya Vinoba Bhave started this movement from Pavnar Maharashtra.

S211. Ans.(a)

Sol. All the trade unions, except Ahmedabad Textile Labor Union, be unified in 1930.

S212. Ans.(d)

Sol. In 1667, under Francis Caron, the company established first factory at Surat and second factory was established at Masulipattanam a year later.

S213. Ans.(d)

Sol. Lord Wellesley remained Governor General of Fort Williams from 1798 to 1805. He described himself as Bengal Tiger.

S214. Ans.(b)

Sol. The Rampa Rebellion of 1922 was a tribal uprising, led by Alluri Sitarama Raju in Godavari Agency of Madras Presidency, British India. It began in August 1922 and lasted until the capture and killing of Raju in May 1924.

S215. Ans.(a)

Sol. St. Francis Church, in Fort Kochi (Fort Cochin), Kochi, originally built in 1503, is the oldest European church in India and has great historical significance as a mute witness to the European colonial struggle in the subcontinent.

S216. Ans.(d)

Sol. The Socialist Party was founded not long after India's independence when Jayprakash Narayan, Basawon Sinha, Acharya Narendra Dev led the CSP out of Congress.

S217. Ans.(b)

Sol. The Salt March, also known as the Dandi March and the Dandi Satyagraha, was an act of nonviolent civil disobedience in colonial India led by Mohandas Karamchand Gandhi to produce salt from the seawater in the coastal village of Dandi.

S218. Ans.(c)

Sol. The Chauri Chaura incident occurred at Chauri Chaura in the Gorakhpur district of the United Province, (modern Uttar Pradesh) in British India on 5 February 1922, when a large group of protesters, participating in the Non-cooperation movement, clashed with police, who opened fire.

S219. Ans.(b)

Sol. The Comrade was a weekly English-language newspaper that was published and edited by Maulana Mohammad Ali between 1911 and 1914. Mohammad Ali was a forceful orator and writer, contributing articles to various newspapers including The Times, The Observer and The Manchester Guardian before he launched The Comrade.

S220. Ans.(d)

Sol. It is believed that the idea of the Congress took concrete shape during a meeting of the Theosophical Convention in Madras in December 1884. In March 1885 a notice was issued convening a meeting of the first Indian National Union at Poona(now Pune) in December of the same year.

S221. Ans.(b)

Sol. The Battle of Buxar: The war between the Company and Mir Qasim began in 1763 and in a series of encounters the Nawab was defeated. He fled to Awadh and formed an alliance with Shuja-ud-Daula the Nawab of Awadh and the fugitive Mughal Emperor Shah Alam II in a final attempt to oust the English from Bengal. It is the beginning of the British rule in India.

S222. Ans.(b)

Sol. Spice was the first thing that encouraged the Europeans for Indian business.

S223. Ans.(a)

Sol. Erode Venkatappa Ramasamy commonly known as Periyar, also referred to as Thanthai Periyar, was an Indian social activist, and politician who started the Self-Respect Movement and Dravidar Kazhagam. He is known as the 'Father of modern Tamilnadu'. He has done exemplary works against Brahminical dominance, caste prevalence and women oppression in Tamilnadu.

S224. Ans.(a)

Sol. Swami Vivekananda at the Parliament of the World's Religions (1893) Swami Vivekananda represented India and Hinduism at the Parliament of the World's Religions (1893). This was the first World's Parliament of Religions and it was held from 11 to 27 September 1893.

S225. Ans.(a)

Sol. Shyamji Krishna Varma was an Indian revolutionary fighter, an Indian patriot, lawyer and journalist who founded the Indian Home Rule Society.

S201. Ans.(d)

Sol. The Edicts of Ashoka are in total 33 inscriptions written on the Pillars, boulders and cave walls of Mauryan Period, during the reign of the Emperor Ashok that are dispersed throughout the Indian Sub-continent covering India, Pakistan and Nepal. Information related to life story of Ashoka, Internal Policy and Foreign policy was found in inscriptions.

S202. Ans.(c)

Sol. The wheel (circle) in Sarnath Pillar indicates Progress.

S203. Ans.(c)

Sol. Harshavardhan's Vallabhi conquest is found in Navsari Copper Plate inscription.

S204. Ans.(b)

Sol. The Yajur Veda is one of the oldest books in the Vedas. Yajurveda is not counted among sub-vedas.

S205. Ans.(d)

Sol. Ashoka through his Dhamma established the ideal of paternal kingship. Through his edicts, he said everybody should serve parents, revere teachers, and practice ahimsa and truthfulness and Charity.

S206. Ans.(c)

Sol. Sri Guru Nanak Dev was born in 1469 in Talwandi, a village in the Sheikhpura district, 65 kms. west of Lahore. His father was a village official in the local revenue administration. As a boy, Sri Guru Nanak learnt, besides the regional languages, Persian and Arabic.

S207. Ans.(c)

Sol. Afonso de Albuquerque was the second governor of the Portuguese India and is known as founder of Portuguese colonial empire in India. Krishna Deva Rai was the friend of the Portuguese Governor Albuquerque.

S208 Ans.(c)

Sol. Cotton and silk were the main textile crops during the medieval period. The cotton textile industry contributed a lot to the development of the economy of Mughal Empire.

S209. Ans.(a)

Sol. Nandalal Bose related to Painting.

S210. Ans.(c)

Sol. The leader of the Individual Satyagraha movement, Acharya Vinoba Bhave started this movement from Pavnar Maharashtra.

S211. Ans.(a)

Sol. All the trade unions, except Ahmedabad Textile Labor Union, be unified in 1930.

S212. Ans.(d)

Sol. In 1667, under Francis Caron, the company established first factory at Surat and second factory was established at Masulipattanam a year later.

S213. Ans.(d)

Sol. Lord Wellesley remained Governor General of Fort Williams from 1798 to 1805. He described himself as Bengal Tiger.

S214. Ans.(b)

Sol. The Rampa Rebellion of 1922 was a tribal uprising, led by Alluri Sitarama Raju in Godavari Agency of Madras Presidency, British India. It began in August 1922 and lasted until the capture and killing of Raju in May 1924.

S215. Ans.(a)

Sol. St. Francis Church, in Fort Kochi (Fort Cochin), Kochi, originally built in 1503, is the oldest European church in India and has great historical significance as a mute witness to the European colonial struggle in the subcontinent.

S216. Ans.(d)

Sol. The Socialist Party was founded not long after India's independence when Jayprakash Narayan, Basawon Sinha, Acharya Narendra Dev led the CSP out of Congress.

S217. Ans.(b)

Sol. The Salt March, also known as the Dandi March and the Dandi Satyagraha, was an act of nonviolent civil disobedience in colonial India led by Mohandas Karamchand Gandhi to produce salt from the seawater in the coastal village of Dandi

S218. Ans.(c)

Sol. The Chauri Chaura incident occurred at Chauri Chaura in the Gorakhpur district of the United Province, (modern Uttar Pradesh) in British India on 5 February 1922, when a large group of protesters, participating in the Non-cooperation movement, clashed with police, who opened fire.

S219. Ans.(b)

Sol. The Comrade was a weekly English-language newspaper that was published and edited by Maulana Mohammad Ali between 1911 and 1914. Mohammad Ali was a forceful orator and writer, contributing articles to various newspapers including The Times, The Observer and The Manchester Guardian before he launched The Comrade.

S220. Ans.(d)

Sol. It is believed that the idea of the Congress took concrete shape during a meeting of the Theosophical Convention in Madras in December 1884. In March 1885 a notice was issued convening a meeting of the first Indian National Union at Poona(now Pune) in December of the same year.

S221. Ans.(b)

Sol. The Battle of Buxar: The war between the Company and Mir Qasim began in 1763 and in a series of encounters the Nawab was defeated. He fled to Awadh and formed an alliance with Shuja-ud-Daula the Nawab of Awadh and the fugitive Mughal Emperor Shah Alam II in a final attempt to oust the English from Bengal.It is the beginning of the British rule in India.

S222. Ans.(b)

Sol. Spice was the first thing that encouraged the Europeans for Indian business.

S223. Ans.(a)

Sol. Erode Venkatappa Ramasamy commonly known as Periyar, also referred to as Thanthai Periyar, was an Indian social activist, and politician who started the Self-Respect

Movement and Dravidar Kazhagam.He is known as the 'Father of modern Tamilnadu'. He has done exemplary works against Brahminical dominance, caste prevalence and women oppression in Tamilnadu.

S224. Ans.(a)

Sol. Swami Vivekananda at the Parliament of the World's Religions (1893) Swami Vivekananda represented India and Hinduism at the Parliament of the World's Religions (1893). This was the first World's Parliament of Religions and it was held from 11 to 27 September 1893.

S225. Ans.(a)

Sol. Shyamji Krishna Varma was an Indian revolutionary fighter, an Indian patriot, lawyer and journalist who founded the Indian Home Rule Society.

**DEFENCE**

200+ English MCQs for Defence 2023 Exam

Directions (1-3): In the following question, out of the four alternatives, select the alternative which best expresses the meaning of the idiom/phrase.

Q1. Zero tolerance

- (a) Accuracy is paramount
- (b) Non-acceptance of antisocial behaviour
- (c) No return without risk
- (d) No problem at all

Q2. Variety is the spice of life

- (a) New experiences make life more interesting
- (b) Experimentation may be risky
- (c) Life is very beautiful
- (d) There is no life without excitement

Q3. Scot-free

- (a) To escape from captivity
- (b) Be free of all responsibilities
- (c) To Get something unexpected
- (d) Without suffering any punishment or injury

Directions (4-8): In the following question, some part of the sentence may have errors. Find out which part of the sentence has an error and select the appropriate option. If a sentence is free from error, select 'No Error'.

Q4. The two men were (1)/ quarrelling with one another (2)/ claiming the same watch as their own. (3)/ No Error (4)

- (a) 1
- (b) 2
- (c) 3
- (d) 4

Q5. Everybody knows (1)/ that Bhutan is the most peaceful (2)/ of all other countries of the world. (3)/ No Error (4)

- (a) 1
- (b) 2
- (c) 3
- (d) 4

Q6. My sister-in-laws (1)/ who lives in Kolkata (2)/ have come to stay with us. (3)/ No Error (4)

- (a) 1
- (b) 2
- (c) 3
- (d) 4

Q7. These kind of clothes (1)/ are rather expensive (2)/ for me to buy. (3)/ No Error (4)

- (a) 1
- (b) 2
- (c) 3
- (d) 4

Q8. Chilika is the (1)/ largest brackish water (2)/ lagoon in Asia. (3)/No Error (4)

- (a) 1
- (b) 2
- (c) 3
- (d) 4

Directions (9-11): Choose the correct synonym of the words from the options given below.

Q9. Opulent

- (a) Fake
- (b) Gloomy
- (c) Rich
- (d) Selfish

Q10. Morose

- (a) Flatter
- (b) Gloomy
- (c) friendly
- (d) Savvy

Q11. Cantankerous

- (a) Humorous
- (b) Quarrelsome
- (c) Remorseful
- (d) Dullness

Directions (12- 14): Choose the correct antonym of the words from the options given below.

Q12. Vibrant

- (a) drab
- (b) gaudy
- (c) jazzy
- (d) vivid

Q13. deep-seated

- (a) chronic
- (b) temporary
- (c) inbred
- (d) subconscious

Q14. Humdrum

- (a) tedious
- (b) trite
- (c) drab
- (d) fascinating

Directions (15-16): In the following question, out of the four alternatives, select the alternative which is the best substitute of the phrase.

Q15. Open to more than one interpretation; not having one obvious meaning.

- (a) trite
- (b) opposite
- (c) exceptional
- (d) ambiguous

Q16. Something widely feared as a possible dangerous occurrence.

- (a) spectre
- (b) beguile
- (c) monolith
- (d) canny

Directions (17-18): In the following question, the sentence given with blank to be filled in with an appropriate word. Select the correct alternative out of the four and indicate it by selecting the appropriate option.

Q17. The higher you climb, the more difficult it ____ to breathe.

- (a) became
- (b) becomes
- (c) has become
- (d) is becoming

Q18. Neha has been crying ____ morning.

- (a) from
- (b) of
- (c) since
- (d) till

Q19. Select the word with the incorrect spelling.

- (a) Conceive
- (b) Leisure
- (c) Neice
- (d) Reign

Q20. Select the word with the incorrect spelling.

- (a) Dictionary
- (b) Irrelevant
- (c) Perishable
- (d) Tangible

Directions (21-25): In the following passage, some of the words have been left out. Read the passage carefully and select the correct answer for the given blank out of the four alternatives.

I had seen this road many years ago when my parents moved to Mundakotukurussi, our ancestral village. However, in those early years, I hadn't begun exploring the countryside. I stored the unknown road in my head under 'One Day I Will'. Ten years ago, when I recovered from a herniated disc, it was to discover that I had a useless left leg. Though I managed to lose the limp, I hated not being able to stride around as I used to. I needed a challenge to tell myself that I wasn't going to buckle to a creature called sciatica. Thus the 'One Day I Will' arrived. "Where does the road by the medical shop lead to?" I asked my parents while visiting them next. "Chalavara," they said. "It's not an easy road to walk on," my father added. "There are too many ups and downs." Chalavara was a superior grade of a village as compared to Mundakotukurussi, with a high school, a fine library, ATMs and several shops. But it also has two approach roads. The one I had chosen was a narrow back road used by the locals and that settled it for me. I needed to know for myself I could walk a road that wasn't going to be easy. And the next day, I would get up and walk that road again.

Q21. What is 'sciatica'?

- (a) A type of animal
- (b) Name of a real place
- (c) Name of an imaginary place
- (d) A herniated disc

Q22. Where did the forefathers of the writer live?

- (a) Chalavara
- (b) Bengaluru
- (c) Mundakotukurussi
- (d) Out of India

Q23. What disability did the writer suffer due to the herniated disc?

- (a) A useless left leg
- (b) Depression
- (c) Loss of memory
- (d) Poor visibility

Q24. 'One Day I Will' is the title of?

- (a) A village
- (b) The unknown road
- (c) A tourist place
- (d) A path famous with

Q25. What makes Chalavara better than Mundakotukurussi?

- (a) It has a high school, a fine library, ATMs and several shops
- (b) It is the place where the writer's ancestors were born
- (c) It is the place where the writer went to school
- (d) It is the place where the writer would walk when he was young

Directions (26-28): In the following question, out of the four alternatives, select the alternative which best expresses the meaning of the idiom/phrase.

Q26. Tongue-in-cheek

- (a) In an insincere way
- (b) To praise wholeheartedly
- (c) A sensational news
- (d) To say something hurtful

Q27. Wear your heart on your sleeve

- (a) a very bold person
- (b) a noble pure person
- (c) make one's feelings apparent
- (d) being overtly polite at all times

Q28. When it rains, it pours

- (a) one getting much less than what one expected
- (b) calamity always occurs in bad times
- (c) you always fall into trouble when you are least prepared
- (d) When something bad occurs, it usually occurs more than once

Directions (29-33): In the following question, some part of the sentence may have errors. Find out which part of the sentence has an error and select the appropriate option. If a sentence is free from error, select 'No Error'.

Q29. The climb upside (1)/ the mountains (2)/ was not easy. (3)/No Error (4)

- (a) 1
- (b) 2
- (c) 3
- (d) 4

Q30. Not too long then, the (1)/ lodge was the only (2)/ place to stay here. (3)/No Error (4)

- (a) 1
- (b) 2
- (c) 3
- (d) 4

Q31. He was able to put (1)/ pen of paper only (2)/ much later. (3)/No Error (4)

- (a) 1
- (b) 2
- (c) 3
- (d) 4

Q32. No sooner did I come out of my home to go to market (1)/ when it started raining heavily (2)/ which drenched me completely. (3)/ No Error (4)

- (a) 1
- (b) 2
- (c) 3
- (d) 4

Q33. Unless you don't obey (1)/ your elders you (2)/ will not succeed in your life. (3)/ No Error (4)

- (a) 1
- (b) 2
- (c) 3
- (d) 4

Q34. Choose the correct synonym of the words from the options given below.

Connoisseur

- (a) Decisive
- (b) Uncivilised
- (c) Discerning Judge
- (d) Narrow-minded

Q35. Choose the correct synonym of the words from the options given below.

Incensed

- (a) Ecstatic
- (b) Exasperated
- (c) Elated
- (d) Blithe

Q36. Choose the correct synonym of the words from the options given below.

Transcend

- (a) Eclipse
- (b) Fizzle
- (c) Abort
- (d) Blunder

Directions (37-39): Choose the correct antonym of the words from the options given below.

Q37. celibate

- (a) chaste
- (b) virtuous
- (c) promiscuous
- (d) continent

Q38. ingestion

- (a) gulp
- (b) slug
- (c) excrete
- (d) chug

Q39. horrify

- (a) affright
- (b) petrify
- (c) appall
- (d) soothe

Directions (40-41): In the following question, out of the four alternatives, select the alternative which is the best substitute of the phrase.

Q40. Average in amount, intensity, quality, or degree.

- (a) moderate
- (b) supernatant
- (c) hobble
- (d) hum

Q41. A factory, where workers are employed at very low wages for long hours and under poor conditions.

- (a) Impalpable
- (b) Outset
- (c) Bloomy
- (d) Sweatshop

Directions (42-43): In the following question, the sentence given with blank to be filled in with an appropriate word. Select the correct alternative out of the four and indicate it by selecting the appropriate option.

Q42. The employee did not ____ to the argument of the manager.

- (a) precede
- (b) exceed
- (c) concede
- (d) recede

Q43. He was sworn ____ as the Prime Minister of our country.

- (a) in
- (b) off
- (c) about
- (d) out

Q44. Select the word with the incorrect spelling.

- (a) Entrepreneur
- (b) Remuneration
- (c) Apprentice
- (d) Soveriegnity

Q45. Select the word with the incorrect spelling.

- (a) Tranquility
- (b) Perseverence
- (c) Resplendence
- (d) Accommodation

Directions (46-50): In the following passage, some of the words have been left out. Read the passage carefully and select the correct answer for the given blank out of the four alternatives.

The quest to find life outside the solar system got a big boost with the discovery of seven Earth-size extra-solar planets, or exoplanets, orbiting a dwarf star about 40 light years away. Unlike earlier discoveries of exoplanets, all seven planets could possibly have liquid water — a key to life as we know it on Earth — with three planets having the greatest chance. This is by far the largest collection of Earth-like planets in the habitable 'Goldilocks' zone of a star — neither too close nor too far from a star, which raises the possibility of liquid water being present on the surface. Only Earth has liquid water in the solar system. Since the dwarf star is much cooler than the Sun, the dimming of light each time a planet passes or transits before the star could be easily recorded from Earth unlike in cases when planets transit a Sun-like bright star. Since the initial discovery of three planets was made using the Chile-based Transiting Planets and Planetesimals Small Telescope, the exoplanet system is called TRAPPIST-1.

Q46. The telescope TRAPPIST is in which country?

- (a) Venezuela
- (b) Argentina
- (c) Chile
- (d) Mexico

Q47. What is essential to have the possibility of life on a planet?

- (a) Presence of atmosphere
- (b) Presence of gravity
- (c) Presence of sunlight
- (d) Presence of liquid water

Q48. What is the 'Goldilocks' zone?

- (a) It is a mythological place about stars and planets
- (b) That place on a planet which has lowest possibility of liquid water.
- (c) The correct distance of a planet from its star to have possibility of having liquid water
- (d) That place on a planet which has the right amount of sunlight

Q49. What made it easier to record the passage of the planet in front of the star?

- (a) The fact that the star is much smaller and cooler than our Sun
- (b) The fact that the star is much bigger and cooler than our Sun
- (c) The fact that the star is much smaller and hotter than our Sun
- (d) The fact that the star is much bigger and hotter than our Sun

Q50. How many planets in our solar system have liquid water?

- (a) Two
- (b) Three
- (c) One
- (d) Four

Directions (51-53): In the following question, out of the four alternatives, select the alternative which best expresses the meaning of the idiom/phrase.

Q51. Add fuel to the fire

- (a) Go from one bad situation to another
- (b) A cause becomes stronger when more people join
- (c) The flame will extinguish if it runs out of oil
- (d) Cause a situation to become worse

Q52. A slap on the wrist

- (a) A mild punishment
- (b) Punishing the wrong person
- (c) To hit someone where it hurts the most
- (d) To threaten someone



Q53. Actions speak louder than words

- (a) Achievers are better than those who talk big
- (b) No action can compensate for saying bad words
- (c) A pen is mightier than a sword
- (d) What someone does mean more than what they say they will do

Directions (54-58): In the following question, some part of the sentence may have errors. Find out which part of the sentence has an error and select the appropriate option. If a sentence is free from error, select 'No Error'.

Q54. Hardly had I reached the (1)/ exhibition where I learnt (2)/ about the major robbery. (3)/ No Error (4)

- (a) 1
- (b) 2
- (c) 3
- (d) 4

Q55. No sooner did the sun rise (1)/ when we resumed the journey (2)/ after having a hasty breakfast. (3)/ No Error (4)

- (a) 1
- (b) 2
- (c) 3
- (d) 4

Q56. My eldest son deals with (1)/ spare parts and manages (2)/ his bread and butter. (3)/ No Error (4)

- (a) 1
- (b) 2
- (c) 3
- (d) 4

Q57. Sneha was accused for murder of her husband (1)/ but the court found her (2)/ not guilty and acquitted her. (3)/ No Error (4)

- (a) 1
- (b) 2
- (c) 3
- (d) 4

Q58. If you had (1)/ told me earlier (2)/ I will help you. (3)/ No Error (4)

- (a) 1
- (b) 2
- (c) 3
- (d) 4

Directions (59-61): Choose the correct synonym of the words from the options given below.

Q59. Drivel

- (a) Intelligent
- (b) Blather
- (c) Judicious
- (d) Sane

Q60. Perseverance

- (a) Endurance
- (b) Cowardice
- (c) Lethargy
- (d) Indolence

Q61. Frivolous

- (a) Captious
- (b) Wise
- (c) Puerile
- (d) Spiritual

Directions (62-64): Choose the correct antonym of the words from the options given below.

Q62. sacred

- (a) pious
- (b) hallowed
- (c) divine
- (d) profane

Q63. outlandish

- (a) droll
- (b) kinky
- (c) common
- (d) grotesque

Q64. coalesce

- (a) separate
- (b) adhere
- (c) cleave
- (d) amalgamate

Directions (65-66): In the following question, out of the four alternatives, select the alternative which is the best substitute of the phrase.

Q65. Things that have been discarded as worthless.

- (a) remains
- (b) flotsam
- (c) shambles
- (d) havoc

Q66. Become apparent through the appearance of symptoms.

- (a) manifest
- (b) distinct
- (c) vague
- (d) divulged

Directions (67-68): In the following question, the sentence given with blank to be filled in with an appropriate word. Select the correct alternative out of the four and indicate it by selecting the appropriate option.

Q67. Rituals play into the _____ understandings of a society.

- (a) tactfully
- (b) tacit
- (c) taciturn
- (d) tacitly

Q68. Repetition bred a sense of _____ with the characters.

- (a) familiarity
- (b) familiar
- (c) familiarly
- (d) familiarise

Q69. Select the word with the incorrect spelling.

- (a) Pedestrain
- (b) Plaintiff
- (c) Potatoes
- (d) Potassium

Q70. Select the word with the incorrect spelling.

- (a) Fabulous
- (b) Gorgeous
- (c) Heterogeneous
- (d) Inocuous

Directions (71-75): In the following passage, some of the words have been left out. Read the passage carefully and select the correct answer for the given blank out of the four alternatives.

But before I could be inspired by these amazing people, I had to cleanse my feed. I know my weaknesses: just last week, Facebook memories reminded me of a pizza party I'd had two years ago and I ended up ordering a chicken dominator, with garlic breadsticks and an jalapeno cheesedip. So much for Day One of Couch to 5K training. I stayed right on that couch. So far I've unfollowed Buzzfeed Tasty, TasteMade (even theiradorable Tiny Kitchen) and several people who have the enviable advantage of being able to eat as much as they want and not put on weight. By my calculations, dark chocolate is healthy, so I'm still following Earth Loaf, Pascati and Mason & Co.

When I finally found a gym I liked, with the best trainers I have had, I unabashedly shared my workouts every day. From shying away from full-length pictures, I reached a point where I could share videos of myself deadlifting and doing back squats with a barbell across my shoulders. It gave me accountability: I challenged myself to go to the gym for 30 classes straight, and I did it. Which reminds me, it's time to start a newchallenge.

Q71. Posts related to which topic does the writer want to remove from her feed?

- (a) Dark Chocolate
- (b) Make-up
- (c) Sari
- (d) Food

Q72. What has the writer succeeded in doing?

- (a) Lost the desired weight
- (b) Succeeded in overcoming temptations to order pizzas
- (c) Attended 30 gym classes without a break
- (d) Removed unhealthy posts including about chocolates

Q73. Which of the following is a page related to chocolate?

- (a) Earth Loaf
- (b) Buzzfeed Tasty
- (c) TasteMade
- (d) Tiny Kitchen

Q74. What weight loss program has the writer enrolled in?

- (a) 30 Straight gym classes
- (b) Couch to 5K
- (c) Mason & Co
- (d) Eat chocolate to lose weight

Q75. What gave the writer accountability?

- (a) Sharing her workout videos on social media
- (b) Unfollowing people and pages not related to health
- (c) Going to the gym daily
- (d) Doing challenging exercises like deadlifting

Directions (76-78): In the following question, out of the four alternatives, select the alternative which best expresses the meaning of the idiom/phrase.

Q76. A blessing in disguise

- (a) A misfortune that eventually has good results
- (b) A person who has changed so much that he is now unrecognisable
- (c) A prayer asking for God's favour
- (d) A bad person hiding his face behind a mask

Q77. Against the clock

- (a) To do a job fast to finish it before a deadline
- (b) Time is money
- (c) Man is a victim of time
- (d) It is useless to fight destiny

Q78. Scapegoat

- (a) Animal sacrifice as an offering to God
- (b) The most useful animal or person
- (c) A lucky person who is forgiven for his crimes
- (d) A person who is blamed for the mistakes of others

Directions (79-83): In the following question, some part of the sentence may have errors. Find out which part of the sentence has an error and select the appropriate option. If a sentence is free from error, select 'No Error'.

Q79. Her mother is (1)/ angry and (2)/ indifferent to me. (3)/ No Error (4)

- (a) 1
- (b) 2
- (c) 3
- (d) 4

Q80. The Tata group own (1)/ many industries, that are spread (2)/ across the globe. (3)/ No Error (4)

- (a) 1
- (b) 2
- (c) 3
- (d) 4

Q81. She has not been (1)/ to the restaurant (2)/ much late. (3)/ No Error (4)

- (a) 1
- (b) 2
- (c) 3
- (d) 4

Q82. My brother finds it difficult (1)/ to pass away the time (2)/ at our grandparent's house. (3)/ No Error (4)

- (a) 1
- (b) 2
- (c) 3
- (d) 4

Q83. No sooner had he finished (1)/ his morning walk (2)/ when it began to rain. (3)/ No Error (4)

- (a) 1
- (b) 2
- (c) 3
- (d) 4

Directions (84-86): Choose the correct synonym of the words from the options given below.

Q84. Petrify

- (a) Adorn
- (b) Calm
- (c) Curious
- (d) Harden

Q85. Succulent

- (a) Sucking
- (b) Soft
- (c) Juicy
- (d) Pale

Q86. Congregation

- (a) Discussion
- (b) Attention
- (c) Contraction
- (d) Assembly

Directions (87-89): Choose the correct antonym of the words from the options given below.

Q87. loiter

- (a) lag
- (b) hasten
- (c) amble
- (d) loll

Q88. fidgety

- (a) composed
- (b) restive
- (c) twitchy
- (d) antsy

Q89. bland

- (a) blah
- (b) insipid
- (c) tame
- (d) lively

Directions (90-91): In the following question, out of the four alternatives, select the alternative which is the best substitute of the phrase.

Q90. Rub a part of the body to restore warmth or sensation.

- (a) Fuzz
- (b) Chafe
- (c) Scum
- (d) Oblique

Q91. The punishment of being kept in school after hours.

- (a) Pretension
- (b) Isolate
- (c) Detention
- (d) Blender

Directions (92-93): In the following question, the sentence given with blank to be filled in with an appropriate word. Select the correct alternative out of the four and indicate it by selecting the appropriate option.

Q92. I sensed the _____ of the argument.

- (a) beautiful
- (b) beautifully
- (c) beauty
- (d) beautification

Q93. The beans are _____ turned to avoid burning.

- (a) constant
- (b) constants
- (c) constantly
- (d) constantedly

Q94. Select the word with the incorrect spelling.

- (a) Tomorrow
- (b) Occurence
- (c) Temperature
- (d) Preferable

Q95. Select the word with the incorrect spelling.

- (a) Receeding
- (b) Cemetery
- (c) Parallelogram
- (d) Rehearsal

Directions (96-100): In the following passage, some of the words have been left out. Read the passage carefully and select the correct answer for the given blank out of the four alternatives.

Genetic variation is the cornerstone of evolution, without which there can be no natural selection, and so a low genetic diversity decreases the ability of a species to survive and reproduce, explains lead author Yoshan Moodley, Professor at the Department of Zoology, University of Venda in South Africa.

Two centuries ago, the black rhinoceros – which roamed much of sub Saharan Africa – had 64 different genetic lineages; but today only 20 of these lineages remain, says the paper. The species is now restricted to five countries, South Africa, Namibia, Kenya, Zimbabwe and Tanzania. Genetically unique populations that once existed in Nigeria, Cameroon, Chad, Eritrea, Ethiopia, Somalia, Mozambique, Malawi and Angola have disappeared. The origins of the 'genetic erosion' coincided with colonial rule in Africa and the popularity of big game hunting. From the second half of the 20th century, however, poaching for horns has dramatically depleted their population and genetic diversity, especially in Kenya and Tanzania.

Q96. What is important for evolution?

- (a) Genetic variation
- (b) Large population
- (c) Mixing of species
- (d) Survival of the fittest

Q97. Sub Saharan Africa has lost how many black rhino genetic lineages in 200 years?

- (a) 64
- (b) 20
- (c) 44
- (d) 30

Q98. Genetically unique black rhinoceros has been lost in all of the following countries, except?

- (a) Tanzania
- (b) Nigeria
- (c) Chad
- (d) Malawi

Q99. From the second half of the 20th century what has caused a dramatic fall in black rhinoceros population?

- (a) poaching
- (b) colonial rule
- (c) big game hunting
- (d) fall in genetic diversity

Q100. Genetic diversity is proportional to _____.

- (a) species population
- (b) the ability of a species to survive and reproduce
- (c) inbreeding
- (d) extinction

Directions (101-103): In the following question, out of the four alternatives, select the alternative which best expresses the meaning of the idiom/phrase.

Q101. A dime a dozen

- (a) Strength is in numbers
- (b) People who say bad things have no value
- (c) Very common and of no particular value
- (d) You save more if you buy in large numbers

Q102. A drop in the bucket

- (a) So much silence that even a drop can be heard
- (b) A very small amount compared with what is needed
- (c) The final act before the task is done
- (d) A small favour is worth a lot to a person in trouble

Q103. Practice makes a man perfect

- (a) Perfection demands patience
- (b) Any problem can be solved if you are willing to try many times
- (c) Regular activity is the way to become proficient in it
- (d) It takes a long time to form a good habit

Directions (104-108): In the following question, some part of the sentence may have errors. Find out which part of the sentence has an error and select the appropriate option. If a sentence is free from error, select 'No Error'.

Q104. On Sundays (1)/ I prefer reading (2)/ than going out visiting my friends. (3)/ No Error (4)

- (a) 1
- (b) 2
- (c) 3
- (d) 4

Q105. Rohit is two year (1)/ junior than Mukesh (2)/ in the office. (3)/ No Error (4)

- (a) 1
- (b) 2
- (c) 3
- (d) 4

Q106. In spite of the doctor's stern warning (1)/ Latika continued taking (2)/ sugars in her milk. (3)/ No Error (4)

- (a) 1
- (b) 2
- (c) 3
- (d) 4

Q107. Myself and Roshni (1)/ will take care of (2)/ the event on Sunday. (3)/ No Error (4)

- (a) 1
- (b) 2
- (c) 3
- (d) 4

Q108. Little knowledge of playing volleyball (1)/ that she possessed proved to be (2)/ helpful at the time of inaugural match. (3)/ No Error (4)

- (a) 1
- (b) 2
- (c) 3
- (d) 4

Directions (109-111): Choose the correct synonym of the words from the options given below.

Q109. Atrocity

- (a) Difficulty
- (b) Barbarity
- (c) Shy
- (d) Gloomy

Q110. Procrastinate

- (a) Divert
- (b) Deceive
- (c) Debase
- (d) Delay

Q111. Mellifluous

- (a) Shiver
- (b) Frank
- (c) Immoral
- (d) Dulcet

Directions (112-114): Choose the correct antonym of the words from the options given below.

Q112. generosity

- (a) altruism
- (b) general
- (c) largesse
- (d) malevolence

Q113. analogue

- (a) correlate
- (b) cognate
- (c) dialogue
- (d) difference

Q114. amusement

- (a) mischief
- (b) naughty
- (c) melancholy
- (d) hilarity

Directions (115-116): In the following question, out of the four alternatives, select the alternative which is the best substitute of the phrase.

Q115. The outer layer of the cerebrum (part of the brain), composed of folded grey matter, plays an important role in the consciousness.

- (a) victor
- (b) cortex
- (c) scrub
- (d) capered

Q116. A hot spring in which water intermittently boils, pushing a tall column of water and steam into the air.

- (a) geyser
- (b) smite
- (c) brew
- (d) pitted

Directions (117-118): In the following question, the sentence given with blank to be filled in with an appropriate word. Select the correct alternative out of the four and indicate it by selecting the appropriate option.

Q117. Fourteen kilometres _____ not a short distance, to reach to my office daily.

- (a) are
- (b) has
- (c) have
- (d) is

Q118. Good reading _____ the sense of liberal educated mind.

- (a) beliefs
- (b) leads
- (c) reflects
- (d) starts

Q119. Select the word with the incorrect spelling.

- (a) Gaurantee
- (b) Itinerary
- (c) Magnificent
- (d) Writing

Q120. Select the word with the incorrect spelling.

- (a) Etiquete
- (b) Exquisite
- (c) Restaurant
- (d) Scavenger

Directions (121-125): In the following passage, some of the words have been left out. Read the passage carefully and select the correct answer for the given blank out of the four alternatives.

Manja, or the glass-coated string used for flying kites, not only poses threat to humans, animals and birds but also to trees. A study by the country's oldest botanical garden has revealed that it poses a great threat to trees. But how can a snapped string struck in a tree kill the tree? Apparently, it does so by allying with the creepers in the garden.

A research paper by three scientists of the Acharya Jagdish Chandra Bose Indian Botanic Garden, located in West Bengal's Howrah district, illustrates in detail how the manja, in collusion with climbers, does the damage. "The abandoned, torn kite strings act as an excellent primary supporting platform for the tender climbers, giving easy passage to reach the top of the trees. Lateral branches from the top of the climber and other accessory branches from the ground reaches the toptaking support of the first climber, completely covers the treetop, thus inhibiting the penetration of sunlight," says the research paper.

Q121. Abandoned, torn kite strings stuck in trees benefits whom?

- (a) Humans
- (b) Creepers
- (c) Birds
- (d) Trees

Q122. How many scientists contributed to a study by country's oldest botanical gardens on how manja can kill a tree?

- (a) Two
- (b) Three
- (c) Five
- (d) Four

Q123. How can a tree be killed by a creeper?

- (a) By blocking its access to sunlight
- (b) By wrapping its tentacles around its branches
- (c) By sucking away the nutrients
- (d) By secreting toxic chemicals

Q124. What would be the acronym for India's oldest botanical garden?

- (a) AJCBIBG
- (b) AJCBBGI
- (c) AJBCIBG
- (d) AJBCBGI

Q125. What gives easy passage to 'climbers' to top of the trees?

- (a) Creepers
- (b) Torn kites
- (c) Lateral branches
- (d) Manja

Directions (126-128): In the following question, out of the four alternatives, select the alternative which best expresses the meaning of the idiom/phrase.

Q126. Pull the plug

- (a) Make a firm refusal
- (b) Save a situation by acting in the nick of time
- (c) To waste away somebody's effort
- (d) Prevent something from continuing

Q127. A hot potato

- (a) A war like situation which could have been easily avoided
- (b) A common eatery but favoured by celebrities
- (c) A controversial situation which is awkward to deal with
- (d) A celebrity who keeps getting into some or the other controversy

Q128. New kid on the block

- (a) New rules which are bound to fail
- (b) A junior
- (c) A new social trend
- (d) A newcomer

Directions (129-133): In the following question, some part of the sentence may have errors. Find out which part of the sentence has an error and select the appropriate option. If a sentence is free from error, select 'No Error'.

Q129. I had not completed my English homework (1)/ so I thought I was done with when the (2)/ teacher asked me to hand it in. (3)/ No Error (4)

- (a) 1
- (b) 2
- (c) 3
- (d) 4

Q130. I was shocked to hear (1)/ that her husband (2)/ died of an accident. (3)/ No Error (4)

- (a) 1
- (b) 2
- (c) 3
- (d) 4

Q131. The reason for (1)/ his failure is because (2)/ he didn't study at all. (3)/ No Error (4)

- (a) 1
- (b) 2
- (c) 3
- (d) 4

Q132. Are not your father (1)/ and your elder brother (2)/ out of town? (3)/ No Error (4)

- (a) 1
- (b) 2
- (c) 3
- (d) 4

Q133. Our office building comprises (1)/ seven floors and a restaurant at the top in an (2)/ area of about eight hundred sq. metres. (3)/ No Error (4)

- (a) 1
- (b) 2
- (c) 3
- (d) 4

Directions (134-136): Choose the correct synonym of the words from the options given below.

Q134. Dodge

- (a) Soften
- (b) Order
- (c) Avoid
- (d) Chaotic

Q135. Monotonous

- (a) Dull
- (b) Timid
- (c) Unfriendly
- (d) Lusty

Q136. Elusive

- (a) Baffling
- (b) Enticing
- (c) Directing
- (d) Soothing

Directions (137-139): Choose the correct antonym of the words from the options given below.

Q137. adulterate

- (a) attenuated
- (b) purify
- (c) vitiated
- (d) dilute

Q138. Conjoined

- (a) sever
- (b) adjoin
- (c) meld
- (d) affix

Q139. mishmash

- (a) potpourri
- (b) medley
- (c) organized
- (d) haphazard

Directions (140-141): In the following question, out of the four alternatives, select the alternative which is the best substitute of the phrase.

Q140. Make something seem less important, significant, or trifling.

- (a) superintend
- (b) optimality
- (c) trivialize
- (d) dumb down

Q141. A gesture expressing respect, such as a bow.

- (a) Consensual
- (b) Obeisance
- (c) Perk
- (d) Germinate

Directions (142-143): In the following question, the sentence given with blank to be filled in with an appropriate word. Select the correct alternative out of the four and indicate it by selecting the appropriate option.

Q142. He ____ to the problem of air pollution in his speech.

- (a) averted
- (b) adverted
- (c) exclaimed
- (d) mentioned

Q143. Rohan is so magnanimous that everyone is always ____ to help him in his project.

- (a) eager
- (b) enthusiastic
- (c) reluctant
- (d) ignorant

Q144. Select the word with the incorrect spelling.

- (a) Hygeine
- (b) Fascist
- (c) Career
- (d) Apparel

Q145. Select the word with the incorrect spelling.

- (a) Reside
- (b) Revise
- (c) Advise
- (d) Demice

Directions (146-150): In the following passage, some of the words have been left out. Read the passage carefully and select the correct answer for the given blank out of the four alternatives.

Everyone expected Mary Zophres to win for her retro-revival Technicolor clothes in La La Land — the eventual winner, Colleen Atwood for Fantastic Beasts and Where to Find Them, seemed surprised too. But as other awards began to slip away from the well-reviewed musical, atheme could be teased out. What is Fantastic Beasts if not a plea for equal treatment of people, magical or otherwise? Then, Arrival, a film about the inherent benignity of aliens (read immigrants) won for Best Sound Editing. Hacksaw Ridge, which is, in a way, an anti-guns movie, won in two categories. Fences, about an African-American father who fears racial discrimination, took home the Oscar for Best Supporting Actress. Earlier, Moonlight, featuring two minority communities (black and gay), won for Best Supporting Actor. This turned out to be one of those yearsthe Oscar voter was underestimated. As a majority of voters are actors, there was the tendency to think they'd reward La La Land, a celebrationof creation: the heroine wants to make movies, the hero wants to make jazz. It looked like the year of The Artist all over again.

Q146. Colleen Atwood won which Award?

- (a) Best Costume Design for La La Land
- (b) Best Supporting Actor for Fantastic Beasts and Where to Find Them
- (c) Best Supporting Actor for La La Land
- (d) Best Costume Design for "Fantastic Beasts and Where to Find Them"

Q147. What does the lead female actor in La La Land want to do?

- (a) Make jazz
- (b) Make movies
- (c) Make music
- (d) Make magic

Q148. Which of the following movies is about kindness of Aliens?

- (a) Hacksaw Ridge
- (b) Arrival
- (c) Fences
- (d) Moonlight

Q149. Why was it assumed that La La Land would win a lot of awards?

- (a) Because the movie celebrates creation
- (b) Because majority of voters are actors
- (c) Because it is a movie about making movies and jazz
- (d) Because it is a retro-revival Technicolor movie

Q150. Which movie for sure won two awards?

- (a) Arrival
- (b) Fences
- (c) Moonlight
- (d) Hacksaw Ridge

Directions (151-153): In the following question, out of the four alternatives, select the alternative which best expresses the meaning of the idiom/phrase.

Q151. Sixth sense

- (a) An intuitive power of perception
- (b) A strong power of sense
- (c) An ability to perceive when something will go wrong
- (d) The false feeling that you know the truth

Q152. Rome was not built in a day

- (a) It takes time to create great things
- (b) You have to win many wars to build an empire
- (c) A task done hurriedly fails completely
- (d) Building anything worthwhile requires skill

Q153. Rule of thumb

- (a) A rough unit of measure for small lengths
- (b) A broadly accurate guide based on practice
- (c) To force someone to work against his wish
- (d) To use your power to ensure discipline

Directions (154-158): In the following question, some part of the sentence may have errors. Find out which part of the sentence has an error and select the appropriate option. If a sentence is free from error, select 'No Error'.

Q154. His name was hardly (1)/ known out (2)/ his own country. (3)/No Error (4)

- (a) 1
- (b) 2
- (c) 3
- (d) 4

Q155. Water was dripping (1)/ of the trees, and (2)/ the grass was wet. (3)/No Error (4)

- (a) 1
- (b) 2
- (c) 3
- (d) 4

Q156. Pravin sat up on the (1)/ sofa, with his legs (2)/ tucked down him. (3)/No Error (4)

- (a) 1
- (b) 2
- (c) 3
- (d) 4

Q157. She was so (1)/ near (2)/ achieving her goal. (3)/No Error (4)

- (a) 1
- (b) 2
- (c) 3
- (d) 4

Q158. He watched as fights (1)/ broke out (2)/ along the city. (3)/No Error (4)

- (a) 1
- (b) 2
- (c) 3
- (d) 4

Directions (159-161): Choose the correct synonym of the words from the options given below.

Q159. Reiterate

- (a) Abuse
- (b) Pretend
- (c) Detest
- (d) Repeat

Q160. Nincompoop

- (a) Wise
- (b) Fool
- (c) Lover
- (d) Companion

Q161. Exorbitant

- (a) Clear
- (b) Dull
- (c) High
- (d) Rare

Directions (162-164): Choose the correct antonym of the words from the options given below.

Q162. virtuous

- (a) vile
- (b) chaste
- (c) kosher
- (d) celibate

Q163. primed

- (a) fit
- (b) able
- (c) unready
- (d) prepped

Q164. pilferer

- (a) sniper
- (b) punk
- (c) lifter
- (d) police

Directions (165-166): In the following question, out of the four alternatives, select the alternative which is the best substitute of the phrase.

Q165. the way in which a substance holds together; thickness or viscosity

- (a) corpulency
- (b) consistency
- (c) exigency
- (d) exultancy

Q166. based on random choice or personal whim

- (a) auxiliary
- (b) arbitrary
- (c) allegory
- (d) ambulatory

Directions (167-168): In the following question, the sentence given with blank to be filled in with an appropriate word. Select the correct alternative out of the four and indicate it by selecting the appropriate option.

Q167. The _____ "pretty ugly" implies that a person can be both attractive and unattractive at the same time.

- (a) simile
- (b) metaphor
- (c) alliteration
- (d) oxymoron

Q168. Finding the comedy routine extremely funny, the family laughed _____ along with the rest of the crowd.

- (a) lot
- (b) hysterically
- (c) crazy
- (d) guffaw

Q169. Select the word with the incorrect spelling.

- (a) Autumn
- (b) Desperate
- (c) Reciept
- (d) Traffic

Q170. Select the word with the incorrect spelling.

- (a) Century
- (b) Finance
- (c) Remember
- (d) Sponser

Directions (171-175): In the following passage, some of the words have been left out. Read the passage carefully and select the correct answer for the given blank out of the four alternatives.

The rural economy is an important segment of the ecosystem and accounts for around 70 percent of employment and 50 percent of GDP with agriculture being the main driver followed by services and manufacturing. It is largely unorganized and hence those working in rural India or consuming in this economy are a different category of economic agents driven by different factors. The economy is quite complex in so far as the fact that cash dominates in terms of transactions and while there has been some intrusion of the use of credit (kisan) and debit cards and ATMs, dependence on technology driven payments system is limited. This has hence also become a haven for routing black money both in terms of seeking tax exemptions by channeling funds, to convert to legitimate funds. But a lot of black money gets into land and ' apparent rural activity '. Now consider some aspects of this economy and the cash conundrum. Almost all transactions in the mandis (there are above 7,000 organized ones and over double the number that is unorganized), are based on cash as it is easy to use. The farmers prefer to receive cash and while some do take in cheques there is a sense of doubt if the counter party is unknown. Hence one reason why electronic mandis is a good idea is that payments can also be made through the electronic mode as all transactions would be e-enabled. The recent demonetization has caused significant distortions as farmers are unable to sell their goods. This has happened just when we are in middle of the kharif harvest which involves rice, soybean, cotton, maize, sugarcane, bajra, besides fruits and vegetables which are all year through. The second issue for Indian agriculture is the rabi season which has begun where farmers start sowing their seeds. The issue here is less serious as a large part is backed by credit where the prevalent cash crunch may not matter. It would only be at the margin that farmers may be impacted, and hence the pain here would be secondary.

Q171. According to the passage, which among the following is the major contributor to India's GDP growth?

- (a) Services
- (b) Agriculture
- (c) Manufacturing
- (d) FDIs

Q172. What has become a haven for routing black money in India?

- (a) Cash transactions over digital cash transactions
- (b) Intrusion of credit cards
- (c) Prevailing debit cards
- (d) Technology driven payment

Q173. Which among the following is not a kharif crop?

- (a) Bajra
- (b) Maize
- (c) Rice
- (d) Wheat

Q174. Why does demonetisation has lesser impact onto the rabi season?

- (a) Due to tax exemptions
- (b) Due to digital payments
- (c) Due to credit payments
- (d) Huge margins

Q175. Which of the following is not true in regards to rural economy?

- (a) It account for major percent in employing the people of the country.
- (b) It has a technology driven mandis.
- (c) Major transactions are based on cash.
- (d) Demonetization has caused significant distortions in rural economy especially to farmers.

Directions (176-178): In questions some parts of the sentences have errors and some are correct. Find out which part of a sentence has an error and choose the alphabet corresponding to that part as your answer. If a sentence is free from error, choose (D) as your answer.

Q176. Why need (A)/ we to give (B)/ our bank details? (C)/ No error (D).

- (a) A
- (b) B
- (c) C
- (d) D

Q177. The thieves couldn't (A)/ have escaped if (B)/ there were policemen. (C)/ No error (D).

- (a) A
- (b) B
- (c) C
- (d) D

Q178. He talks as (A)/ if he owns (B)/ the whole world (C)/ No error. (D)

- (a) A
- (b) B
- (c) C
- (d) D

Directions (179-181): In these questions, sentences are given with blanks to be filled in with an appropriate word(s). Four alternatives are suggested for each question. Choose the correct alternative out of the four alternatives.

Q179. The criminal surrendered and _____ to jail.

- (a) sent
- (b) were sent
- (c) had sent
- (d) send

Q180. Their speech didn't _____ anything substantial.

- (a) Infer
- (b) imply
- (c) understand
- (d) bring

Q181. The woodcutter has _____ the log into 2 pieces.

- (a) sown
- (b) sawn
- (c) broken
- (d) sawed

Directions (182-184): In these questions, a sentence or a part of sentence is bold. Below are given alternatives to the bold part which may improve the sentence. Choose the correct alternative. In case no improvement is needed, your answer is (D)

Q182. I **have been knowing** him for 6 years.

- (a) had been knowing
- (b) had known
- (c) have known
- (d) No improvement

Q183. He **has lain** much stress on it.

- (a) has laid
- (b) had lain
- (c) had laid
- (d) No improvement

Q184. They denied **watching** T.V. shows.

- (a) to watch
- (b) watch
- (c) seeing
- (d) No improvement

Directions (185-187): In the following questions, out of the four alternatives choose the one which can be substituted for the given words/sentence.

Q185. A person who enters without any invitation

- (a) Burglar
- (b) Intruder
- (c) Thief
- (d) Vandal

Q186. The period between two reigns

- (a) Lapse
- (b) Interregnum
- (c) Stasis
- (d) Intermission

Q187. Poem in short stanzas narrating a popular story.

- (a) Ballet
- (b) Epic
- (c) Ballad
- (d) Sonnet

Directions (188-189): In these questions, out of the four alternatives, choose the one which best expresses the meaning of the word given in bold.

Q188. Numinous

- (a) Profane
- (b) Divine
- (c) prosaic
- (d) unholy

Q189. Bucolic

- (a) Helpless
- (b) Intoxicated
- (c) Shameless
- (d) Rustic

Directions (190-191): In these questions, choose the word opposite in meaning to the word given in bold.

Q190. Crass

- (a) Gross
- (b) Refined
- (c) Coarse
- (d) Dense

Q191. Reprisal

- (a) Relief
- (b) forgiveness
- (c) Exemption
- (d) Relaxation

Q192. In these questions, four words are given out of which only one is **correctly spelt**. Find that **correctly spelt** word

- (a) soperceed
- (b) soperseed
- (c) superceeds
- (d) supersede

Directions (193-195): In these questions, four alternatives are given for the idiom/phrase given in **bold** in the sentence. Choose the alternative which best expresses the meaning of the idiom/phrase given in **bold**.

Q193. To put somebody in his place

- (a) to turn him out
- (b) to honour him
- (c) to give him due respect
- (d) to make him humble

Q194. To talk shop

- (a) to talk nonsense
- (b) to talk reasonably
- (c) to talk about business
- (d) to abuse someone

Q195. To keep one's head above water

- (a) To be cautious
- (b) To keep out of debt
- (c) To remain aloof
- (d) None of these

Directions (196-200): Read the passages carefully and choose the best answer to each question out of the four alternatives.

There is a confused notion in the minds of many persons that the gathering of the property of the poor into the hands of the rich does no ultimate harm, since in whoever hands it may be, it must be spent at last, and thus, they think, returns to the poor again. This fallacy has been again and again exposed; but granting the plea true, the same apology may, of course, be made for blackmail, or any other form of robbery. It might be (though practically it never is) as advantageous for the nation that the robber should have the spending of the money he extorts, as that the person robbed should have spent it. But this is no excuse for the theft. If I were to put a turnpike on the road where it passes my own gate, and endeavor to exact a shilling from every passenger, the public would soon do away with my gate, without listening to any pleas on my part that it was as advantageous to them, in the end, that I should spend their shillings, as that they themselves should. But if, instead of outfacing them with a turnpike, I can only persuade them to come in and buy stones, or old iron, or any other useless thing, out of my ground, I may rob them to the same extent, and be, moreover, thanked as a public benefactor and promoter of commercial prosperity. And this main question for the poor of England - for the poor of all countries - is wholly omitted in every treatise on the subject of wealth. Even by the laborers themselves, the operation of capital is regarded only in its effect on their immediate interests, never in the far more terrific power of its appointment of the kind and the object of labor. It matters little, ultimately, how much a laborer is paid for making anything; but it matters fearfully what the thing is, which he is compelled to make. If his labor

is so ordered as to produce food, fresh air, and fresh water, no matter that his wages are low, the food and the fresh air and water will be at last there, and he will at last get them. But if he is paid to destroy food and fresh air, or to produce iron bars instead of them, the food and air will finally not be there, and he will not get them, to his great and final inconvenience. So that, conclusively, in political as in household economy, the great question is, not so much what money you have in your pocket, as what you will buy with it and do with it.

Q196. It can be inferred that, in regard to the accumulation of wealth, the author

- (a) equates the rich with the thief.
- (b) thinks that there are few honest businessmen.
- (c) condones some dishonesty in business dealings.
- (d) believes destruction of property is good because it creates consumer demand.

Q197. We may infer that the author probably lived in the

- (a) 1960's in the United States.
- (b) Victoria age in England
- (c) 18th-century France.
- (d) Golden Age of Greece.

Q198. The passage implies that

- (a) "A stitch in time saves nine."
- (b) "It is better late than never."
- (c) "He who steals my purse steals trash."
- (d) "There are two sides of every story"

Q199. According to the passage, the individual should be particularly concerned with

- (a) how much wealth he can accumulate.
- (b) the acquisition of land property rather than money.
- (c) charging the customer a fair price.
- (d) the quality of goods which he purchases with his funds.

Q200. What does the passage not indicate?

- (a) Stealing is something pardonable
- (b) There are legal ways to rob the public
- (c) The poor are being abused
- (d) Workers' wages are of little concern to the nation-at-large

Directions (201-203): In questions some parts of the sentences have errors, and some are correct. Find out which part of a sentence has an error and choose the alphabet corresponding to that part as your answer. If a sentence is free from error, choose (D) as your answer.

Q201. Manish is pleased to sanction one (A) / special increment to all the (B) / employees with this month. (C) / No error (D)

- (a) A
- (b) B
- (c) C
- (d) D

Q202. Your children should not sit (A) / close to the T.V set (B) / as it affects on their eyes. (C) / No error (D)

- (a) A
- (b) B
- (c) C
- (d) D

Q203. Emphasis on quality of life ensures (A) / for the health and happiness (B) of every person. (C) / No error (D)

- (a) A
- (b) B
- (c) C
- (d) D

Directions (204-206): In these questions, sentences are given with blanks to be filled in with an appropriate word(s). Four alternatives are suggested for each question. Choose the correct alternative out of the four alternatives.

Q204. They have a profound respect for his political_____.

- (a) involvement
- (b) ambition
- (c) personality
- (d) sagacity

Q205. The bus was _____ the traffic and the police man asked the driver to move off.

- (a) Failing
- (b) Obstructing
- (c) Obviating
- (d) Hiding

Q206. His actions had _____ pain and suffering on his family member.

- (a) deplored
- (b) imposed
- (c) affected
- (d) inflicted

Directions (207-209): In these questions, a sentence or a part of sentence is Bold. Below are given alternatives to the underlined part which may improve the sentence. Choose the correct alternative. In case no improvement is needed, your answer is (D)

Q207. If we will pray sincerely, God will listen to our payers.

- (a) we pray
- (b) we are praying
- (c) we will be praying
- (d) No-improvement

Q208. In shiva's views, we are going to present a report soon

- (a) As
- (b) on
- (c) for
- (d) No-improvement

Q209. Hardly had they finished writing the letter **before** Anil arrived
 (a) Then
 (b) While
 (c) When
 (d) No-improvement

Directions (210-212): In these questions, four alternatives are given for the idiom/phrase given in bold in the sentence. Choose the alternative which best expresses the meaning of the idiom/phrase given in bold.

Q210. A green horn
 (a) An envious lady
 (b) A trainee
 (c) An in experienced man
 (d) A soft-hearted man

Q211. To be old as the hills
 (a) to be very ancient
 (b) to be wise and learned
 (c) to be old but foolish
 (d) No being worth the age

Q212. To cut the crackle
 (a) to humiliate
 (b) to annoy someone
 (c) to act in a friendly way
 (d) to stop talking and start

Directions (213-215): In the following questions, out of the four alternatives choose the one which can be substituted for the given words/sentence.

Q213. A small, named group of fixed stars
 (a) Galaxy
 (b) Cluster
 (c) Constellation
 (d) Congregation

Q214. Room with toilet facilities
 (a) Suite
 (b) Deluxe
 (c) Lavatory
 (d) Cabin

Q215. To surround with armed forces
 (a) Seize
 (b) A hack
 (c) Cease
 (d) Besiege

Solutions

S1. Ans.(b)

Sol. Zero tolerance means absolutely no toleration of even the smallest infraction of a rule. Tolerance cannot be related with accuracy.

S2. Ans.(a)

Sol. Variety is the spice of life means new and exciting experiences make life more interesting.

S3. Ans.(d)

Sol. Scot-free means to escape punishment for a crime or wrongdoing; to be acquitted of charges for a crime.

S4. Ans.(b)

Sol. Replace 'one another' with 'each other'. each other is used between two things.

S5. Ans.(c)

Sol. Use 'in' in place of 'of' because we use phrase "in the world".

S6. Ans.(a)

Sol. It should be "My sister-in law" instead of "My sister-in-laws".

S7. Ans.(a)

Sol. It should be "kinds of" instead of "kind of" because "these" is plural determiner which makes the noun plural in front of it.

S8. Ans.(d)

Sol. No error

S9. Ans.(c)

Sol. Opulent means ostentatiously costly and luxurious. Hence rich is the correct choice.

S10. Ans.(b)

Sol. Morose means sullen and ill-tempered and Gloomy means dark or poorly lit, especially so as to appear depressing or frightening.

S11. Ans.(b)

Sol. Cantankerous means bad-tempered, argumentative, and uncooperative. Quarrelsome means given to or characterized by quarrelling.

S12. Ans.(a)

Sol. Vibrant means full of energy and life and drab means lacking brightness or interest; drearily dull.

S13. Ans.(b)

Sol. deep-seated means strongly felt or believed and very difficult to change or get rid of and temporary means lasting for only a limited period of time; not permanent.

S14. Ans.(d)

Sol. Humdrum means lacking excitement or variety; boringly monotonous and fascinating means extremely interesting. Hence options (d) is the correct choice.

S15. Ans.(d)

Sol. Ambiguous means having or expressing more than one possible meaning, sometimes intentionally.

S16. Ans.(a)

Sol. Spectre means something widely feared as a possible dangerous occurrence.

Beguile means charm or enchant (someone), often in a deceptive way.

Monolith means a large single upright block of stone, especially one shaped into or serving as a pillar or monument.

S17. Ans.(b)

S18. Ans.(c)

S19. Ans.(c)

Sol. Niece means a daughter of one's brother or sister, or of one's brother-in-law or sister-in-law.

S20. Ans.(a)

Sol. Dictionary means a reference book on a particular subject, the items of which are typically arranged in alphabetical order.

S21. Ans.(d)

Sol. According to the passage, 'sciatica' means herniated disc.

S22. Ans.(c)

Sol. The forefathers of the writer lives in 'Mundakotukurussi'.

S23. Ans.(a)

Sol. Refer to, "Ten years ago, when I recovered from a herniated disc, it was to discover that I had a useless left leg."

S24. Ans.(b)

Sol. Refer to, "I stored the unknown road in my head under 'One Day I Will'."

S25. Ans.(a)

Sol. Refer to, "There are too many ups and downs." Chalavara was a superior grade of a village as compared to Mundakotukurussi, with a high school, a fine library, ATMs and several shops.

S26. Ans.(a)

Sol. Tongue-in-cheek means Jocular or humorous, though seeming or appearing to be serious.

S27. Ans.(c)

Sol. Wear your heart on your sleeve means to display one's feelings openly and habitually, rather than keep them private.

S28. Ans.(d)

Sol. When it rains, it pours means something good or bad occurring multiple times within a short span of time.

S29. Ans.(a)

Sol. It should be "Climbing" in place of "The climb", as to mention activity we need to use gerund as the subject of the sentence.

S30. Ans.(a)

Sol. It should be "ago" instead of "then". To show the context of past we use "ago".

S31. Ans.(b)

Sol. Use 'on' in place of 'of'. "Pen on paper" is a phrase which means "to write".

S32. Ans.(b)

Sol. "no sooner" takes "than" with it, thus option (b) is correct.

S33. Ans.(a)

Sol. "unless" itself is a negative verb thus it won't take "not" with it.

S34. Ans.(c)

Sol. Connoisseur means an expert judge in matters of taste. Hence Discerning Judge is the correct choice.

S35. Ans.(b)

Sol. Incensed means very angry; enraged and Exasperated means irritate intensely; infuriate.

S36. Ans.(a)

Sol. Transcend means be or go beyond the range or limits of (a field of activity or conceptual sphere) and Eclipse means an obscuring of the light from one celestial body by the passage of another between it and the observer or between it and its source of illumination. Eclipse as a verb means "to be greater in significance than".

S37. Ans.(c)

Sol. Celibate means not having sexual activity, especially because you have made a religious promise not to and promiscuous means having a lot of different sexual partners or sexual relationships, or (of sexual habits) involving a lot of different partners.

S38. Ans.(c)

Sol. Ingestion means the process of taking food, drink, or another substance into the body by swallowing or absorbing it and excrete means (of a living organism or cell) separate and expel as waste (a substance, especially a product of metabolism).

S39. Ans.(d)

Sol. Horrify means fill with horror; shock greatly and soothe means reduce pain or discomfort in (a part of the body).



S40. Ans.(a)

Sol. Moderate is the one which is the substitute of the phrase average in amount, intensity, quality, or degree.

S41. Ans.(d)

Sol. Sweatshop means a factory or workshop, especially in the clothing industry, where manual workers are employed at very low wages for long hours and under poor conditions.

S42. Ans.(c)**S43. Ans.(a)****S44. Ans.(d)**

Sol. Sovereignty means the authority of a state to govern itself or another state.

S45. Ans.(b)

Sol. Perseverance means persistence in doing something despite difficulty or delay in achieving success.

S46. Ans.(c)

Sol. Refer to, "Since the initial discovery of three planets was made using the Chile-based Transiting Planets and Planetesimals Small Telescope, the exoplanet system is called TRAPPIST-1."

S47. Ans.(d)

Sol. Refer to, "Unlike earlier discoveries of exoplanets, all seven planets could possibly have liquid water — a key to life as we know it on Earth."

S48. Ans.(c)

Sol. Refer to, "This is by far the largest collection of Earth-like planets in the habitable 'Goldilocks' zone of a star — neither too close nor too far from a star, which raises the possibility of liquid water being present on the surface."

S49. Ans.(a)

Sol. Refer to, "Since the dwarf star is much cooler than the Sun, the dimming of light each time a planet passes or transits before the star could be easily recorded from Earth unlike in cases when planets transit a Sun-like bright star.

S50. Ans.(c)

Sol. Refer to, "Only Earth has liquid water in the solar system.

S51. Ans.(d)

Sol. Add fuel to the fire means to do or say something to make an argument, problem, or bad situation worse; to further incense an already angry person or group of people.

S52. Ans.(a)

Sol. A slap on the wrist means a mild reprimand or punishment.

S53. Ans.(d)

Sol. Actions speak louder than words mean actions are more revealing of one's true character since it is easy to say things or make promises, but it takes effort to do things and follow through.

S54. Ans.(b)

Sol. Use 'when' in place of 'where' because Hardly had/scarcely had takes "when" with it.

S55. Ans.(b)

Sol. Use 'then' in place of 'when' because no sooner did takes "then" with it.

S56. Ans.(a)

Sol. "deal in" is the correct word.

deal in: to buy and sell a particular product

S57. Ans.(a)

Sol. "accused" takes "of" preposition with it.

S58. Ans.(c)

Sol. as the first clause is in past thus the next clause should be in past also thus change "will" to "would".

S59. Ans.(b)

Sol. Drivel means nonsense and Blather means talk in a long-winded way without making very much sense.

S60. Ans.(a)

Sol. Perseverance means persistence in doing something despite difficulty or delay in achieving success and Endurance means the ability to endure an unpleasant or difficult process or situation without giving way.

S61. Ans.(c)

Sol. Frivolous: not having any serious purpose or value.

Puerile: childishly silly and immature.

S62. Ans.(d)

Sol. Sacred means connected with God or a god or dedicated to a religious purpose and so deserving veneration and profane means not relating to that which is sacred or religious; secular.

S63. Ans.(c)

Sol. Outlandish means looking or sounding bizarre or unfamiliar and common means occurring, found, or done often; prevalent.

S64. Ans.(a)

Sol. Coalesce means come together to form one mass or whole. Hence separate is the correct choice.

S65. Ans.(b)

Sol. Flotsam means people or things that have been rejected or discarded as worthless.

S66. Ans.(a)

Sol. Manifest means clear or obvious to the eye or mind.

S67. Ans.(b)**S68. Ans.(a)****S69. Ans.(a)**

Sol. pedestrian: a person walking rather than travelling in a vehicle.

S70. Ans.(d)

Sol. Innocuous: not harmful or offensive.

S71. Ans.(d)

Sol. Refer to, "I had to cleanse my feed. I know my weaknesses: just last week, Facebook memories reminded me of a pizza party I'd had two years ago and I ended up ordering a chicken dominator, with garlic breadsticks and an jalapeno cheesedip."

S72. Ans.(c)

Sol. Refer to, "I challenged myself to go to the gym for 30 classes straight, and I did it. Which reminds me, it's time to start a newchallenge."

S73. Ans.(a)

Sol. Refer to, "By my calculations, dark chocolate is healthy, so I'm still following Earth Loaf, Pascati and Mason & Co."

S74. Ans.(b)

Sol. Refer to, "So much for Day One of Couch to 5K training. I stayed right on that couch. So far I've unfollowed Buzzfeed Tasty, TasteMade (even theiradorable Tiny Kitchen) and several people who have the enviable advantage of being able to eat as much as they want and not put on weight."

S75. Ans.(a)

Sol. refer to, "I reached a point where I could share videos of myself deadlifting and doing back squats with a barbell across my shoulders. It gave me accountability."

S76. Ans.(a)

Sol. A blessing in disguise means an unfortunate event or situation that results in an unforeseen positive outcome.

S77. Ans.(a)

Sol. Against the clock means in a very limited amount of time; with a shortage of time being the main problem.

S78. Ans.(d)

Sol. Scapegoat means to make someone take the blame for something.

S79. Ans.(b)

Sol. Angry at –someone or something- to be irritated by
Angry with- someone or something- when we show displeasure, disappointment.

S80. Ans.(b)

Sol. Use "which" at the place of "that" as the second clause is non-defining clause and we don't use "that" with non-defining clause. "That" is always used with defining clause.

S81. Ans.(c)

Sol. "been" is a verb which must be qualified with an adverb and "lately" is an verb which must be used.

S82. Ans.(b)

Sol. pass away: polite expression for die verb. It should be "to pass the time".

S83. Ans.(c)

Sol. No sooner Than are used as a pair. Thus "when" should be replaced with "than".

S84. Ans.(d)

Sol. Petrify: make (someone) so frightened that they are unable

S85. Ans.(c)

Sol. Succulent means tender, juicy, and tasty. Hence option (c) is the correct choice.

S86. Ans.(d)

Sol. Congregation means a group of people assembled for religious worship. Hence option (d) is the correct choice.

S87. Ans.(b)

Sol. Loiter means stand or wait around without apparent purpose and hasten means be quick to do something.

S88. Ans.(a)

Sol. Fidgety means inclined to fidget; restless or uneasy and composed means having one's feelings and expression under control; calm.

S89. Ans.(d)

Sol. Bland means lacking strong features or characteristics and therefore uninteresting and lively means full of life and energy; active and outgoing.

S90. Ans.(b)

Sol. Chafe means (with reference to a part of the body) make or become sore by rubbing against something.

S91. Ans.(c)

Sol. Detention means the punishment of being kept in school after hours.

Pretension means a claim or assertion of a claim to something. Blender means a person or thing that mixes things together, in particular an electric mixing machine used in food preparation for liquidizing, chopping, or pureeing.

S92. Ans.(c)**S93. Ans.(c)****S94. Ans.(b)**

Sol. Occurrence: an incident or event.

S95. Ans.(a)

Sol. Receding: go or move back or further away from a previous position.

S96. Ans.(a)

Sol. Refer to, "Genetic variation is the cornerstone of evolution, without which there can be no natural selection, and so a low genetic diversity decreases the ability of a species to survive and reproduce."

S97. Ans.(c)

Sol. Refer to, "Two centuries ago, the black rhinoceros – which roamed much of sub Saharan Africa – had 64 different genetic lineages; but today only 20 of these lineages remain, says the paper."

S98. Ans.(a)

Sol. Refer to, "The species is now restricted to five countries, South Africa, Namibia, Kenya, Zimbabwe and Tanzania. Genetically unique populations that once existed in Nigeria, Cameroon, Chad, Eritrea, Ethiopia, Somalia, Mozambique, Malawi and Angola have disappeared."

S99. Ans.(a)

Sol. Refer to, "From the second half of the 20th century, however, poaching for horns has dramatically depleted their population and genetic diversity, especially in Kenya and Tanzania."

S100. Ans.(b)

Sol. Genetic diversity is proportional to the ability of a species to survive and reproduce.

S101. Ans.(c)

Sol. A dime a dozen means very common and of no particular value.

S102. Ans.(b)

Sol. A drop in the bucket means a tiny amount, especially when compared to a much larger one.

S103. Ans.(c)

Sol. Practice makes a man perfect means Only by practicing or repeatedly doing something can one become proficient or skillful at it.

S104. Ans.(c)

Sol. prefer takes "to" with it for the comparison.

S105. Ans.(b)

Sol. junior/senior takes "to" with it for the comparison.

S106. Ans.(c)

Sol. sugar is a material noun which is uncountable thus "sugar" should be used.

S107. Ans.(a)

Sol. A sentence should not be started with "myself". And the sequence which should be used when multiple pronouns are used is 231. Thus, it should be "Roshni and I".

S108. Ans.(a)

Sol. "little" shows "negligible knowledge" that is almost zero, however this can't be true because context shows knowledge was helpful this means there must have been some knowledge and to represent "some" we use "a little". Thus "a little" should be used in part (a)

S109. Ans.(b)

Sol. Atrocity: an extremely wicked or cruel act, typically one involving physical violence or injury.
Barbarity: extreme cruelty or brutality.

S110. Ans.(d)

Sol. Procrastinate: delay or postpone action; put off doing something.
Debase: reduce (something) in quality or value; degrade.

S111. Ans.(d)

Sol. Mellifluous: pleasingly smooth and musical to hear.
Dulcet: sweet and soothing

S112. Ans.(d)

Sol. Generosity means the quality of being kind and generous and malevolence means the state or condition of being malevolent where malevolent means having or showing a wish to do evil to others.

S113. Ans.(d)

Sol. Analogue means a person or thing seen as comparable to another. Hence difference is the correct choice.

S114. Ans.(c)

Sol. Amusement means the state or experience of finding something funny and melancholy means a feeling of pensive sadness, typically with no obvious cause.

S115. Ans.(b)

Sol. Cortex means the outer layer of the cerebrum (the cerebral cortex), composed of folded grey matter and playing an important role in consciousness.
Capered means skip or dance about in a lively or playful way.

S116. Ans.(a)

Sol. Geyser means a hot spring in which water intermittently boils, sending a tall column of water and steam into the air.
Smite means be strongly attracted to someone or something.
Brew means make (beer) by soaking, boiling, and fermentation.
Pitted means having a hollow or indentation on the surface.

S117. Ans.(d)**S118. Ans.(b)****S119. Ans.(a)**

Sol. Guarantee: a formal assurance (typically in writing) that certain conditions will be fulfilled, especially that a product will be repaired or replaced if not of a specified quality.
Itinerary: a planned route or journey.

S120. Ans.(a)

Sol. Etiquette: the customary code of polite behavior in society or among members of a particular profession or group.
Exquisite: extremely beautiful and delicate.
Scavenger: a person who searches for and collects discarded items.

S121. Ans.(b)

Sol. Refer to, "The abandoned, torn kite strings act as an excellent primary supporting platform for the tender climbers, giving easy passage to reach the top of the trees." Apparently, it does so by allying with the creepers in the garden.

S122. Ans.(b)

Sol. Refer to, "A research paper by three scientists of the Acharya Jagdish Chandra Bose Indian Botanic Garden, located in West Bengal's Howrah district."

S123. Ans.(a)

Sol. Refer to, "Lateral branches from the top of the climber and other accessory branches from the ground reaches the top taking support of the first climber, completely covers the treetop, thus inhibiting the penetration of sunlight," says the research paper."

S124. Ans.(a)

Sol. Refer to, "A research paper by three scientists of the Acharya Jagdish Chandra Bose Indian Botanic Garden."

S125. Ans.(d)

Sol. Manja gives easy passage to 'climbers' to top of the trees.

S126. Ans.(d)

Sol. Pull the plug means to remove, turn off, or discontinue someone's life-support system, resulting in their death.

S127. Ans.(c)

Sol. A hot potato means a sensitive situation or controversial issue that is difficult to handle and thus gets passed from one person to the next.

S128. Ans.(d)

Sol. New kid on the block means a newcomer to a particular place or sphere of activity.

S129. Ans.(b)

Sol. "was done with" should be replaced with "would do with". Do with is a phrasal verb which means "to finish" or "to brought to an end". In the question "Thought" shows that he must have thought to complete homework in future and for the future with respect to past we use "would".

S130. Ans.(c)

Sol. "an accident" is an event and the correct form is to die in an event.

E.g. He died in a car accident.

He died in a mishap.

"Die of" is used with disease.

He died of malaria.

S131. Ans.(b)

Sol. As the word "reason" has already been used thus the word "because" should not be used as it will be superfluous since both the words is used to give "excuse".

S132. Ans.(d)

Sol. no error

S133. Ans.(b)

Sol. "at the top" is used when we are not referring to the top most point of something but it is somewhat higher but not the top most point but when we are referring to the top most point then "on the top" should be used.

S134. Ans.(c)

Sol. dodge: avoid (someone or something) by a sudden quick movement.

Chaotic: in a state of complete confusion and disorder.

S135. Ans.(a)

Sol. Monotonous means dull, tedious, and repetitious; lacking in variety and interest.

S136. Ans.(a)

Sol. Elusive means difficult to find, catch, or achieve and Baffling means impossible to understand; perplexing.

S137. Ans.(b)

Sol. Adulterate means render (something) poorer in quality by adding another substance. Hence purity is the correct choice.

S138. Ans.(a)

Sol. conjoined means join; combine and sever means divide by cutting or slicing, especially suddenly and forcibly.

S139. Ans.(c)

Sol. mishmash means a confused mixture. Hence organized is the correct choice.

S140. Ans.(c)

Sol. Trivialize means make (something) seem less important, significant, or complex than it really is.

S141. Ans.(b)

Sol. Obeisance means a gesture expressing deferential respect, such as a bow or curtsy.

Consensual means relating to or involving consent or consensus.

Germinate means begin to grow and put out shoots after a period of dormancy.

S142. Ans.(b)**S143. Ans.(a)****S144. Ans.(a)**

Sol. Hygiene means conditions or practices conducive to maintaining health and preventing disease, especially through cleanliness.

S145. Ans.(d)

Sol. Demise means a person's death.

S146. Ans.(d)

Sol. Refer to, "Everyone expected Mary Zophres to win for her retro-revival Technicolor clothes in La La Land — the eventual winner, Colleen Atwood for Fantastic Beasts and Where to Find Them, seemed surprised too.

S147. Ans.(b)

Sol. Refer to, "As a majority of voters are actors, there was the tendency to think they'd reward La La Land, a celebration of creation: the heroine wants to make movies."

S148. Ans.(b)

Sol. Refer to, "Then, Arrival, a film about the inherent benignity of aliens (read immigrants) won for Best Sound Editing.

S149. Ans.(b)

Sol. Refer to, "As a majority of voters are actors, there was the tendency to think they'd reward La La Land, a celebration of creation: the heroine wants to make movies, the hero wants to make jazz."

S150. Ans.(d)

Sol. Refer to, "Hacksaw Ridge, which is, in a way, an anti-guns movie, won in two categories."

S151. Ans.(a)

Sol. Sixth sense means a supposed power to know or feel things that are not perceptible by the five senses of sight, hearing, smell, taste, and touch.

S152. Ans.(a)

Sol. Rome was not built in a day: Important work takes time

S153. Ans.(b)

Sol. Rule of thumb: a broadly accurate guide or principle, based on practice rather than theory.

S154. Ans.(b)

Sol. Sentence is in passive but "his own country" cannot be the agent thus his own country need to be added with the rest of the sentence. conjunction is used to connect one sentence to another however preposition should be used as "his own country" is not a clause or a sentence. Conjunction is used to connect the clause. Thus, the correct preposition is "of". Or "out" can be replaced with "in".

His name was hardly known out of his own country.

His name was hardly known in his own country.

S155. Ans.(b)

Sol. "of" should be replaced with "down". Drip down means fall in small drops.

S156. Ans.(c)

Sol. tucked under is the correct term to be used.

S157. Ans.(d)

Sol. no error.

S158. Ans.(c)

Sol. usage of "along" is incorrect. Along means "by the side of". "Across" means from one side to another. Thus "along" should be replaced with "across".

S159. Ans.(d)

Sol. Reiterate: say something again or a number of times or to repeat something.

S160. Ans.(b)

Sol. Nincompoop: a foolish or stupid person.

S161. Ans.(c)

Sol. Exorbitant: unreasonably high.

S162. Ans.(a)

Sol. vile: extremely unpleasant.

Chaste: abstaining from extramarital, or from all, sexual intercourse.

Kosher: genuine and legitimate.

Celibate: abstaining from marriage and sexual relations, typically for religious reasons.

S163. Ans.(c)

Sol. primed: to make something ready for use or action, in particular.

Prepped: to prepare something ready.

S164. Ans.(d)

Sol. pilferer: a thief who steals without using violence.

Punk: A worthless person (often used as a general term of abuse).

S165. Ans.(b)

Sol. corpulence: something more than average fatness.

exigency: an urgent need or demand.

Exultancy: triumphantly happy.

S166. Ans.(b)

Sol. arbitrary: based on random choice or personal whim, rather than any reason or system.

Auxiliary: providing supplementary or additional help and support.

Allegory: a story, poem, or picture that can be interpreted to reveal a hidden meaning, typically a moral or political one.

ambulatory: Relating to or adapted for walking.

S167. Ans.(d)

Sol. oxymoron: two words used together that have, or seem to have, opposite meanings.

S168. Ans.(b)

Sol. Hysterically means used to emphasize how funny something is.

S169. Ans.(c)

Sol. Receipt means the action of receiving something or the fact of its being received.

S170. Ans.(d)

Sol. Sponsor means a person or organization that pays for or contributes to the costs involved in staging a sporting or artistic event in return for advertising.

S171. Ans.(b)

Sol. Refer to, "The rural economy is an important segment of the ecosystem and accounts for around 70 percent of employment and 50 percent of GDP with agriculture being the main driver followed by services and manufacturing."

S172. Ans.(a)

Sol. Refer to, "The economy is quite complex in so far as the fact that cash dominates in terms of transactions and while there has been some intrusion of the use of credit (kisan) and debit cards and ATMs, dependence on technology driven payments system is limited. This has hence also become a haven for routing black money both in terms of seeking tax exemptions by channeling funds, to convert to legitimate funds."

S173. Ans.(d)

Sol. Refer to, "This has happened just when we are in middle of the kharif harvest which involves rice, soybean, cotton, maize, sugarcane, bajra, besides fruits and vegetables which are all year through."

S174. Ans.(c)

Sol. Refer to, "The second issue for Indian agriculture is the rabi season which has begun where farmers start sowing their seeds. The issue here is less serious as a large part is backed by credit where the prevalent cash crunch may not matter."

S175. Ans.(b)

Sol. "It has a technology driven mandis" is the only option which is not true in regards to rural economy.

S176. Ans.(b)

Sol. Remove 'to'. Because 'need' is a modal and it necessary that modals have base form of verb.

S177. Ans.(c)

Sol. Replace 'were' with 'had been'. Because it is a Conditional mood.

S178. Ans.(b)

Sol. Use 'owned' in place of 'owns'. Because it is a past subjunctive mood.

S179. Ans.(b)

Sol. 'were sent'. Because it is a passive sentence.

S180. Ans.(b)

Sol. 'Imply', Imply means to suggest or hint.

S181. Ans.(b)

Sol. 'sawn'. Sawn means to cut. And. It is a V₃.

S182. Ans.(c)

Sol. 'have known'. We can't use 'know' in continuous form.

S183. Ans.(a)

Sol. Use 'has laid' in place of 'has lain.'

Laid → to place, to set

Lain → to be situated placed.

S184. Ans.(d)

Sol. No improvement.

S185. Ans.(b)

Sol. 'Intruder'

Burglar → a person who enters a house illegally to steal.

Vandal → a person who destroys public buildings.

S186. Ans.(b)

Sol. 'Interregnum'

Lapse → a mistake or failure.

Stasis → A period or state of inactivity

S187. Ans.(c)

Sol. 'Ballad'

Ballet → a theatrical performance of dancing

Epic → a long poem telling a story of great deeds.

Sonnet → a type of poem with fourteen lines.

S188. Ans.(b)

Sol. 'Divine'

S189. Ans.(d)

Sol. 'fustic'

S190. Ans.(b)

Sol. 'Refined'

Crass → Stupid

S191. Ans.(b)

Sol. 'forgiveness'

Reprisal → something bad done to someone in return.

S192. Ans.(d)

Sol. 'Supersede'

S193. Ans.(d)

Sol. To make him humble.

S194. Ans.(c)

Sol. to talk about business.

S195. Ans.(b)

Sol. To keep out of debt.

S196. Ans.(c)

Sol. It can be inferred that, in regard to the accumulation of wealth, the author condones some dishonesty in business dealings.

S197. Ans.(b)

Sol. We may infer that the author probably lived in the Victoria age in England

S198. Ans.(d)

Sol. The passage implies that "There are two sides of every story".

S199. Ans.(d)

Sol. The passage emphasizes "What the thing is".

S200. Ans.(c)

Sol. The passage does not indicate that the poor are being abused.

S201. Ans.(c)

Sol. Use "from" in place of "with"

S202. Ans.(c)

Sol. Drop 'on', Do not use any preposition with "affect" verb.

S203. Ans.(b)

Sol. Drop "for" because 'Ensures' means 'make sure' or 'make safe' A thing 'ensures' something, not 'ensures for'.

S204. Ans.(d)

Sol. Sagacity → It means intelligence or good knowledge about something.

S205. Ans.(b)

Sol. Obstructing means block (an opening, path, road, etc.); be or get in the way of.

S206. Ans.(d)

Sol. Inflicted means cause (something unpleasant or painful) to be suffered by someone or something.

S207. Ans.(a)

Sol. We pray
In complete sentences, we don't use future tense in both sentences. We use one future tense's sentence and one with present indefinite tense.

S208. Ans.(c)

Sol. 'For'

S209. Ans.(c)

Sol. When

S210. Ans.(c)

Sol. An inexperienced man

S211. Ans.(a)

Sol. To be very ancient

S212. Ans.(d)

Sol. To stop talking and start.

S213. Ans.(c)

Sol. Constellation

Galaxy → very large group of stars

Cluster → A closely- packed group (of people or things)

Congregation → A group gathered together, especially in church

S214. Ans.(c)

Sol. Lavatory

Suite → A number of things forming a set

Deluxe → very luxurious

Cabin → A small house or hut

S215. Ans.(d)

Sol. Besiege

Seize → To take or grasp suddenly (by force)

Attack → The action of attacking

Cease → To stop or end.

**DEFENCE**

100+ Quantitative MCQs for Defence 2023 Exam

Q1. A sum becomes Rs 2286 in 3 years and Rs 2448 in 4 years at simple interest. What is the rate (in percentage) of interest per annum?

- (a) 10
- (b) 9
- (c) 8
- (d) 11

Q2. Selling price of a fan is Rs 4644. If profit percentage is 29%, then what is the cost price (in Rs) of fan?

- (a) 5900
- (b) 3500
- (c) 3800
- (d) 3600

Q3. The marked price of a helmet is 30% more than its cost price. If the helmet is sold for Rs 744 after a discount of Rs 36, then what will be the profit percentage?

- (a) 24
- (b) 18
- (c) 21
- (d) 27

Q4. S, T and U together can complete a work in 30 days. If the ratio of efficiency of S, T and U is 20 : 15 : 12 respectively, then in how many days U alone can complete the same work?

- (a) 195/2
- (b) 235/2
- (c) 225/2
- (d) 215/2

Q5. A train is moving at the speed of 90 km/hr. How many seconds it will take to cover a distance of 2275 meter?

- (a) 96
- (b) 91
- (c) 86
- (d) 93

Q6. Length and breadth of a rectangle are increased by 40% and 70% respectively. What will be the percentage increase in the area of rectangle?

- (a) 118
- (b) 110
- (c) 138
- (d) 128

Q7. U and V started a business by investing amounts Rs 184000 and Rs 224000 respectively. If U's share in the profit received at the end of year is Rs 20700, then what will be the total profit (in Rs) earned by them together?

- (a) 43200
- (b) 45900
- (c) 52300
- (d) 56400

Q8. Calculate the value of $\frac{(61681 \times 61681 - 31681 \times 31681)}{30000}$

- (a) 93352
- (b) 94362
- (c) 93362
- (d) 95362

Q9. The marked price of a chair is 40% more than its cost price. If the chair is sold for Rs 520 after a discount of Rs 40, then what will be the profit percentage?

- (a) 33
- (b) 40
- (c) 25
- (d) 30

Q10. Which of the following statement(s) is/are TRUE?

- I. $2\sqrt{3} > 3\sqrt{2}$
- II. $4\sqrt{2} > 2\sqrt{8}$

- (a) Only I
- (b) Only II
- (c) Neither I nor II
- (d) Both I and II

Q11. A missile travels at 1260 km/h. How many metres does it travel in one second?

- (a) 322 metres
- (b) 369 metres
- (c) 384 metres
- (d) 350 metres

Q12. A shopkeeper, sold almonds at the rate Rs 1250 per kg and bears a loss of 7%. Now if he decides to sell it at Rs 1375 per kg, what will be the result?

- (a) 4.6 percent gain
- (b) 2.3 percent loss
- (c) 2.3 percent gain
- (d) 4.6 percent loss

Q13. Madhur works 2 times faster than Sagar. If Sagar can complete a job alone in 18 days, then in how many days can they together finish the job?

- (a) 5 days
- (b) 2 days
- (c) 6 days
- (d) 4 days

Q14. The bus fare between two cities is increased in the ratio 11:18. What would be the increase in the fare, if the original fare is Rs 550?

- (a) Rs 350
- (b) Rs 900
- (c) Rs 180
- (d) Rs 360

Q15. If $xy = 22$ and $x^2 + y^2 = 100$, then what will be the value of $(x + y)$?

- (a) 12

- (b) 144
(c) 72
(d) 6

Q16. Two students appeared for an examination. One of them secured 20 marks more than the other and his marks were 55% of the sum of their marks. The marks obtained by them are

- (a) 92 and 72
(b) 83 and 63
(c) 110 and 90
(d) 64 and 44

Q17. 25% discount is offered on an item. By applying a promo code the customer wins 8% cash back. What is the effective discount?

- (a) 35.75 percent
(b) 35 percent
(c) 31 percent
(d) 12.5 percent

Q18. Prabhat has done $\frac{1}{2}$ of a job in 12 days. Santosh completes the rest of the job in 6 days. In how many days can they together do the job?

- (a) 12 days
(b) 4 days
(c) 8 days
(d) 16 days

Q19. x and y are two numbers such that their mean proportion is 16 and third proportion is 128. What is the value of x and y ?

- (a) 8 and 16
(b) 16 and 32
(c) 8 and 32
(d) 16 and 16

Q20. In the first 32 overs of a cricket match, the run rate was 7.2 runs/over. What is the required run rate in the remaining 18 overs to reach the target of 297 runs?

- (a) 4.3
(b) 4.9
(c) 3.1
(d) 3.7

Q21. The difference between simple and compound interests compounded annually on a certain sum of money for 2 years at 16% per annum is Rs 320. What is the value of given sum (in Rs)?

- (a) 25000
(b) 50000
(c) 37500
(d) 12500

Q22. Of the 5 numbers whose average is 76, the first is $\frac{3}{7}$ times the sum of other 4. The first number is

- (a) 171

- (b) 114
(c) 76
(d) 228

Q23. If $(36 - 16x) - (4x - 8) = 4$, then the value of x is

- (a) 4
(b) 2
(c) 6
(d) 3

Q24. Marked price of an item is Rs 400. On purchase of 1 item discount is 6% and on purchase of 4 items discount is 24%. Rachita buys 5 items, what is the effective discount?

- (a) 34 percent
(b) 20.4 percent
(c) 12.8 percent
(d) 23.25 percent

Q25. $199994 \times 200006 = ?$

- (a) 39999799964
(b) 39999999864
(c) 39999999954
(d) 39999999964

Q26. Calculate the value of $0.77777 + 0.7777 + 0.777 + 0.77 + 0.7 + 0.07$

- (a) 3.86274
(b) 3.80247
(c) 3.85274
(d) 3.87247

Q27. A crate of egg holds one rotten egg out of every 25 egg in it. If 5 out of 8 rotten eggs are unusable and there are total 10 unusable eggs in the crate, then calculate the number of eggs in the crate.

- (a) 380
(b) 400
(c) 420
(d) 440

Q28. Rs 18200 is divided among X, Y and Z in the ratio of $\frac{1}{3} : \frac{1}{4} : \frac{1}{2}$. What is the share (in Rs) of X?

- (a) 7000
(b) 4400
(c) 4200
(d) 5600

Q29. In what ratio must a mixture of 20% milk strength be mixed with that of 60% milk strength so as to get a new mixture of 25% milk strength?

- (a) 7 : 1
(b) 4 : 1
(c) 5 : 2
(d) 9 : 2

Q30. What is the average of first 39 even numbers?

- (a) 39
(b) 40

- (c) 20
(d) 68

Q31. If $31x + 31y = 403$, then what is the average of x and y ?

- (a) 3.5
(b) 5
(c) 6.5
(d) 13

Q32. A sum of Rs 7500 is divided into two parts. The simple interest on first part at the rate of 12% per annum is equal to the simple interest on second part at the rate of 18%. What is the interest (in Rs) on each part for one year?

- (a) 600
(b) 360
(c) 480
(d) 540

Q33. Selling price of a calculator is Rs 13924 and profit percentage is 18%. If selling price is Rs 10266, then what will be the loss percentage?

- (a) 17.2
(b) 13
(c) 14.9
(d) 11

Q34. Rohit wants to earn 21% profit on a belt after offering 45% discount. By how much percentage more should he mark the price of his article above the cost price?

- (a) 75.45
(b) 120
(c) 66
(d) 102.5

Q35. What is the value of $\sqrt{513 - \sqrt{144 - \sqrt{81 - \sqrt{64}}}}$?

- (a) 22
(b) 21
(c) 28
(d) 19

Q36. Two taps P and Q can fill a tank in 24 hours and 18 hours respectively. If the two taps are opened at 11 a.m., then at what time (in p.m.) should the tap P be closed to completely fill the tank at exactly 2 a.m.?

- (a) 5
(b) 2
(c) 3
(d) 4

Q37. If Anuj walks at the speed of 4 km/hr, then he reaches his school 6 minutes late but if he walks at the speed of 5 km/hr, then he reaches 6 minutes before the scheduled time. What is the distance (in km) of his school from his house?

- (a) 4
(b) 3
(c) 6
(d) 3.5

Q38. The average weight of two players P and Q of a football team is 38 kg. The average weight of P, Q and their coach T is 49 kg. What is the weight (in kg) of coach?

- (a) 71
(b) 46
(c) 76
(d) 91

Q39. A sum of Rs 1200 amounts to Rs 1740 in 3 years at simple interest. If rate of interest is increased by 3%, then what will be the new amount (in Rs.)?

- (a) 1848
(b) 1946
(c) 1812
(d) 1924

Q40. If cost price of an article is 75% of its selling price, then what will be the profit percentage?

- (a) 23.47
(b) 25
(c) 33.33
(d) 20

Q41. The average age of a Royal family of 6 members 4 year ago was 25 years. Meanwhile a child was born in this family and still the average age of the whole family is same today. The present age of the child is:

- (a) 2 years
(b) $11\frac{1}{2}$ years
(c) 1 year
(d) data insufficient

Q42. There were five sections in BOM Banking Exam paper. The average score of Pallavi in first 3 sections was 83 and the average in the last 3 sections was 97 and the average of all the sections (i.e., whole paper) was 92, then her score in the third section was:

- (a) 85
(b) 92
(c) 80
(d) 90

Q43. Sahnaaz spends $\frac{3}{4}$ of his salary. Now his salary increased by 20% and his expenditure is increased by 10%. Find out the percentage increment in his savings?

- (a) 75%
(b) 25%
(c) 50%
(d) Can't be determined

Q44. X's salary is 20% less of y's. Now find out how much percent y's salary is more than that of x's salary.

- (a) 20%
(b) 40%
(c) $16\frac{1}{6}\%$
(d) 25%

Q45. A man earn $x\%$ on the first Rs. 2000 and $y\%$ on the rest of his income. If he earns Rs. 700 from Rs. 4000 and 900 from

Rs. 5000 of income. How much he earn in the income of Rs. 11000.

- (a) 2400 Rs.
- (b) 2300 Rs.
- (c) 2200 Rs.
- (d) 2100 Rs.

Q46. The number that must be added to each of the numbers 8, 21, 13 and 31 to make the ratio of first two numbers equal to the ratio of last two numbers is:

- (a) 5
- (b) 9
- (c) 7
- (d) None of these

Q47. The incomes of A and B are in the ratio 3: 2 and their expenditures in the ratio 5: 3. If each saves Rs. 1000, A's income is:

- (a) Rs. 5000
- (b) Rs. 6000
- (c) Rs. 8000
- (d) None of these

Q48. The ratio of the number of students studying in schools A, B and C is 6: 8: 7 respectively. If the number of students studying in each of the schools is increased by 20%, 15% and 20% respectively, what will be the new ratio of the number of students in Schools A, B and C?

- (a) 18 : 23 : 21
- (b) 12 : 18 : 1
- (c) 18 : 21 : 17
- (d) Cannot be determined

Q49. A sells a tube to B at a profit of 25% and B sells it to C at profit of 20%. If C pays Rs 450 for it, what did A pay for it?

- (a) Rs 240
- (b) Rs 247.5
- (c) Rs 300
- (d) Rs 500

Q50. A property dealer sells a house for Rs. 6,30,000 and in the bargain, makes a profit of 5%. Had he sold it for Rs. 5,00,000, then what percentage of loss or gain he would have made?

- (a) $2\frac{1}{4}\%$ loss
- (b) 10% loss
- (c) $12\frac{1}{2}\%$ loss
- (d) $16\frac{2}{3}\%$ loss

Q51. If a merchant offers a discount of 20% on the list price, then she makes a loss of 16%. What % profit or % loss will she make if she sells goods at a discount of 10% of the list price?

- (a) 14 percent profit
- (b) 20 percent profit
- (c) 50 percent profit
- (d) 5.5 percent loss

Q52. The sum of all prime numbers between 30 and 42 is

- (a) 103
- (b) 109
- (c) 105
- (d) 104

Q53. The value of x for which the expressions $12 - 6x$ and $4x + 2$ become equal is

- (a) 0
- (b) 2
- (c) 1
- (d) 4

Q54. To travel 816 km, an Express train takes 9 hours more than Rajdhani. If however, the speed of the Express train is doubled, it takes 4 hours less than Rajdhani. What is the speed of Rajdhani?

- (a) 48 km/hr
- (b) 62.8 km/hr
- (c) 33.2 km/hr
- (d) 77.5 km/hr

Q55. If $4pxy = (x + 2y)^2 - (x - 2y)^2$, then what will be the value of p?

- (a) 0.5
- (b) 0.25
- (c) 4
- (d) 2

Q56. In the first 26 overs of a cricket match, the run rate was 5.4 runs/over. What is the required run rate in the remaining 24 overs to reach the target of 294 runs?

- (a) 7
- (b) 6.4
- (c) 7.6
- (d) 5.8

Q57. Find two numbers whose sum is 29 and the product is 100.

- (a) 20, 5
- (b) 20, 9
- (c) 25, 4
- (d) 10, 10

Q58. A laborer can do a job in 50 hours. After 5 hours he takes a break. What fraction of the job is yet to be done?

- (a) 0.8
- (b) 0.5
- (c) 0.75
- (d) 0.9

Q59. In an army selection process, the ratio of selected to unselected candidates was 6:1. If 30 less had applied and 10 less selected, the ratio of selected to unselected would have been 7:1. How many candidates had applied for the process?

- (a) 910
- (b) 1820
- (c) 455
- (d) 2730

Q60. Ticket for an adult is Rs 1600 and a child is Rs 1200. 1 child goes free with two adults. If a group has 23 adults and 10 children what is the discount the group gets?

- (a) 25.95 percent
- (b) 24.59 percent
- (c) 25.77 percent
- (d) 31.60 percent

Q61. A shopkeeper by selling 17 Omega watches earns a profit equal to the selling price of 7 Omega watches. What is his profit percentage?

- (a) 41.1 percent
- (b) 82.2 percent
- (c) 70 percent
- (d) 12.2 percent

Q62. The mean of marks secured by 30 students in division-A of class X is 67, 55 students of division-B is 63 and that of 40 students of division-C is 61. What is the mean of marks of the students of three divisions of Class X?

- (a) 63.32
- (b) 62.62
- (c) 61.92
- (d) 64.72

Q63. At what rate of compound interest per annum will a sum of Rs 50000 become Rs 73205 in 2 years?

- (a) 21 percent
- (b) 19 percent
- (c) 17 percent
- (d) 15 percent

Q64. A bag has Rs 30.8 in the form of 1 rupee, 50 paise and 10 paise coins in the ratio of 6:3:2. What is the number of 50 paise coins?

- (a) 8
- (b) 24
- (c) 12
- (d) 4

Q65. Two students appeared for an examination. One of them secured 13 marks more than the other and his marks were 76% of the sum of their marks. The marks obtained by them are

- (a) 19 and 6
- (b) 34 and 21
- (c) 102 and 89
- (d) 92 and 79

Q66. What least number must be added to 1039, so that the sum obtained is completely divisible by 29?

- (a) 4
- (b) 5
- (c) 8
- (d) 6

Q67. If a merchant offers a discount of 4% on the list price, then she makes a loss of 10%. What % profit or % loss will she make if she sells at a discount of 20% of the list price?

- (a) 25 percent loss
- (b) 4 percent loss
- (c) 50 percent profit
- (d) 26 percent profit

Q68. Raj sells a machine for Rs 51 lakhs at a loss. Had he sold it for Rs 60 lakh, his gain would have been 8 times the earlier loss. What is the cost price of the machine?

- (a) Rs 59 lakhs
- (b) Rs 52 lakhs
- (c) Rs 66.375 lakhs
- (d) Rs 45 lakhs

Q69. The difference between simple and compound interests compounded annually on a certain sum of money for 2 years at 12% per annum is Rs 72. What is the value of given sum (in Rs)?

- (a) 10000
- (b) 20000
- (c) 5000
- (d) 15000

Q70. The average weight of Shivshankar, Gopesh and Reena is 97 kg. If the average weight of Shivshankar and Gopesh is 93 kg and that of Gopesh and Reena is 82 kg, then the weight of Gopesh is

- (a) 72
- (b) 56
- (c) 59
- (d) 63

Q71. The population of a town is 300000. It increases annually at the rate of 10%. What will be the population after 2 years?

- (a) 360000
- (b) 363000
- (c) 331000
- (d) 366000

Q72. The incomes of X and Y are in the ratio 2 : 3 and their expenditure are in the ratio 3 : 2. If X saves Rs 7000 and Y saves Rs 15000, then what will be the income (in Rs) of X?

- (a) 12800
- (b) 21400
- (c) 12400
- (d) 18600

Q73. X starts a business with Rs 40000. After 6 months Y joins X with Rs 50000. After 2 years, what will be the ratio of profit of X and Y?

- (a) 16 : 15
- (b) 4 : 5
- (c) 8 : 9
- (d) 14 : 15

Q74. What is the average of all the two digit natural numbers?

- (a) 50
- (b) 45.5
- (c) 54.5
- (d) 90

Q75. If the time increases by 6 years, then simple interest increases by Rs. 3600 on a sum of Rs. 6000. What is the rate (in percentage) of interest per annum?

- (a) 15
- (b) 16
- (c) 10
- (d) 12

Q76. Cost price of an article is Rs. 6000. If the loss percentage is 25%, then what is the selling price (in Rs.) of the article?

- (a) 4500
- (b) 4450
- (c) 4420
- (d) 5100

Q77. The marked price of an article is 40% more than its cost price. If the article is sold for Rs 400 after offering a discount of Rs 20, then what will be the profit percentage?

- (a) $45\frac{2}{3}$
- (b) $33\frac{1}{3}$
- (c) $66\frac{1}{3}$
- (d) $87\frac{2}{3}$

Q78. What is the value of $\frac{\sqrt{32+\sqrt{72}}}{\sqrt{8}}$?

- (a) 8
- (b) 4
- (c) 5
- (d) 10

Q79. A, B and C together can complete a work in 15 days. If the ratio of efficiency of A, B and C is 15 : 10 : 6 respectively, then in how many days C alone can complete the same work?

- (a) $427/6$
- (b) $425/6$
- (c) $465/6$
- (d) $445/6$

Q80. A boy crosses a 500 metres wide road in 50 seconds. What is his speed (in km/hr)?

- (a) 18
- (b) 54
- (c) 36
- (d) 27

Q81. Find the value of $\sqrt[3]{\frac{4096}{1728}}$

- (a) 4/3
- (b) 3/4
- (c) 1/2
- (d) 1/3

Q82. The sum of two numbers is 25 and sum of their square is 373. Calculate the numbers.

- (a) 15, 10
- (b) 18, 7
- (c) 11, 14
- (d) 12, 13

Q83. The value of $\frac{(0.94)^3+(0.1)^3}{(0.94)^2-0.094+(0.1)^2}$ is :

- (a) 0.84
- (b) 0.95
- (c) 1.94
- (d) 1.04

Q84. The correct expression of $7.\overline{47}$ in the fractional form is :

- (a) $\frac{747}{99}$
- (b) $\frac{74740}{1000}$
- (c) $\frac{740}{100}$
- (d) $\frac{740}{99}$

Q85. Calculate the value of $0.66666 + 0.6666 + 0.666 + 0.66 + 0.6 + 0.06$

- (a) 3.36274
- (b) 3.30246
- (c) 3.45274
- (d) 3.31926

Q86. If $2x - 1 < 5x + 2$ and $2x + 5 < 6 - 3x$, then x can take which of the following values?

- (a) 1
- (b) 0
- (c) 2
- (d) 3

Q87. A carpenter can build a cupboard in 60 hours. After 15 hours he takes a break. What fraction of the cupboard is yet to be built?

- (a) 0.5
- (b) 0.9
- (c) 0.75
- (d) 0.25

Q88. There is 75% increase in an amount in 5 years at simple interest. What will be the compound interest of Rs 40000 after 2 years at the same rate?

- (a) Rs 25800
- (b) Rs 32250
- (c) Rs 12900
- (d) Rs 19350

Q89. Rahul sells a machine for Rs 50 lakhs at a loss. Had he sold it for Rs 60 lakh, his gain would have been 7 times the earlier loss. What is the cost price of the machine?

- (a) Rs 51.25 lakhs
- (b) Rs 58.75 lakhs
- (c) Rs 67.14 lakhs
- (d) Rs 43.75 lakhs

Q90. If Girilal's salary is $\frac{11}{7}$ times of Hariram's and Shekhar's is $\frac{3}{4}$ times of Hariram's, what is the ratio of Girilal's salary to Shekhar's salary.

- (a) 44:21
- (b) 28:33
- (c) 33:28
- (d) 21:44

Q91. Find the number that is as much greater than 49 as is less than 95.

- (a) 23
- (b) 55
- (c) 72
- (d) 76

Q92. Tanzeem spent $\frac{1}{5}$ of his salary on his friends, $\frac{1}{10}$ of his salary on accommodation and $\frac{1}{4}$ of his salary on savings. If he has Rs. 1800 left in his wallet, then find his total expenditure on accommodation and savings.

- (a) Rs. 1,200
- (b) Rs. 1,400
- (c) Rs. 1,600
- (d) Rs. 1,800

Q93. If $P = 350$ and $Q = 600$, then P is how much percentage less than Q ?

- (a) 41.66
- (b) 58.33
- (c) 71.42
- (d) 35.33

Q94. The ratio of two numbers is $5 : 4$. If the sum of both the numbers is 180, then what is the smaller number among both the numbers?

- (a) 100
- (b) 80
- (c) 60
- (d) 75

Q95. P started a business by the investing Rs 35000 and Q joined him after one year with an amount of Rs 21000. After two years from the starting of the business, they earned profit of Rs 26000. What will be the P's share (in Rs) in the profit?

- (a) 15000
- (b) 18000
- (c) 20000
- (d) 16000

Q96. On dividing $24a^2b^2$ by $6b^2$, we will get

- (a) $4b^2$
- (b) $4a^2$
- (c) $4a^2b^2$
- (d) 4

Q97. To travel 612 km, an Express train takes 9 hours more than Rajdhani. If the speed of the Express train is doubled, it takes 3 hours less than Rajdhani. The speed (in km/hr) of Rajdhani is

- (a) 40.8
- (b) 51
- (c) 30.6
- (d) 61.2

Q98. Pradeep has done $\frac{1}{4}$ th of a job in 14 days, Saquib completes the rest of the job in 56 days. In how many days can they together complete the job?

- (a) 64 days
- (b) 32 days
- (c) 16 days
- (d) 8 days

Q99. What is the value of 2 consecutive natural numbers, sum of whose squares is 145?

- (a) 8, 9
- (b) 6, 7
- (c) 13, 14
- (d) 9, 10

Q100. If in a two digit number, the digit at unit place is z and the digit at tens place is 8, then the number is

- (a) $80z + z$
- (b) $80 + z$
- (c) $8z + 8$
- (d) $80z + 8$

Q101. Two vessels of equal capacity contains juice and water in the ratio of $5 : 1$ and $5 : 7$ respectively. The mixture of both the vessels are mixed and transferred into a bigger vessel. What is the ratio of juice and water in the new mixture?

- (a) $3 : 2$
- (b) $5 : 3$
- (c) $5 : 4$
- (d) $1 : 2$

Q102. In an alloy, aluminium and tin are in the ratio of $4 : 5$. In the second alloy, the ratio of same elements is $4 : 7$. If equal quantities of these two alloys be mixed to form a new alloy, then what will be the ratio of both of these elements in the new alloy?

- (a) $2 : 3$
- (b) $16 : 35$
- (c) $4 : 5$
- (d) $40 : 59$

Q103. Among four bags, average weight of last three bags is 18 kg and the average weight of first three bags is 19 kg. If the weight of last bag is 22 kg, then what is the weight (in kg) of first bag?

- (a) 32
- (b) 24
- (c) 33
- (d) 25

Q104. A sum becomes Rs 8800 in 4 years at simple interest at the yearly interest rate of 25% per annum. What is the sum (in Rs)?

- (a) 4400
- (b) 6600
- (c) 7040
- (d) 6400

Q105. Cost price of an article is Rs 360. If the profit percentage is 32%, then what is the value (in Rs) of profit?

- (a) 126.2
- (b) 108.2
- (c) 115.2
- (d) 105.2

Q106. Rohit buys a ball for Rs 450 and sells it. Rohit gives two successive discount of 20% and 5% to the customer. What will be the selling price (in Rs) of the ball?

- (a) 342
- (b) 354
- (c) 334
- (d) 362

Q107. What is the value of $\sqrt{2^6 + 15^2}$?

- (a) 17
- (b) 19
- (c) 15
- (d) 21

Q108. A work can be completed by 18 boys in 24 days. If 6 boys leave after working for 12 days, then how many days will be needed to complete the remaining work?

- (a) 12
- (b) 15
- (c) 18
- (d) 24

Q109. Two trains are moving in the same direction at the speed of 42 km/hr and 84 km/hr, their lengths are 320 metres and 380 metres respectively. What is the time taken (in seconds) by faster train to cross the slower train?

- (a) 60
- (b) 80
- (c) 90
- (d) 120

Q110. Which of the following statement(s) is/are TRUE?

- I. $4\sqrt{3} > 3\sqrt{4}$
- II. $8\sqrt{2} > 2\sqrt{8}$
- (a) Only I
- (b) Only II
- (c) Neither I nor II
- (d) Both I and II

Q111. Find the number which is NOT a prime number.

- (a) 89
- (b) 87
- (c) 79
- (d) 97

Q112. Which of the following is the largest number among $\sqrt{2}$, $\sqrt[3]{3}$, $\sqrt{4}$, $\sqrt[3]{5}$.

- (a) $\sqrt{2}$
- (b) $\sqrt[3]{3}$
- (c) $\sqrt{4}$
- (d) $\sqrt[3]{5}$

Q113. What is the value of $13 \times 49^{\frac{3}{2}}$?

- (a) 4369
- (b) 4459
- (c) 4549
- (d) 4639

Q114. What is the value of $\frac{a^2+b^2}{a^3-b^3}$, when $a + b = 8$ and $a - b = 2$?

- (a) 0.313
- (b) 0.347
- (c) 0.368
- (d) 0.381

Q115. A number is divided into two parts in such a way that 30% of first part is 25 more than the 20% of second part. 50% of second part is 33.5 more than the 60% of first part. What is the number?

- (a) 1475
- (b) 1655
- (c) 1425
- (d) 1905

Q116. The price of an article is cut by 3%. To restore to its original value, the new price must be increased by

- (a) 3 percent
- (b) 7.11 percent
- (c) 3.09 percent
- (d) 2.69 percent

Q117. Simple interest on a certain sum of money for 3 years at 8% per annum is half the compound interest on Rs. 16000 for 2 years at 10% per annum. The sum placed on simple interest is:

- (a) Rs 14000
- (b) Rs 3500
- (c) Rs 7000
- (d) Rs 5600

Q118. On dividing $144a^3b^3c^3$ by $24b^2c$, we get

- (a) $6a^3bc^2$
- (b) $24a^3bc^2$
- (c) $24b^2c$
- (d) $6a^3b^2c$

Q119. Ticket for an adult is Rs 1600 and a child is Rs 1200. 1 child goes free with two adults. If a group has 23 adults and 10 children what is the discount the group gets?

- (a) 25.95 percent
- (b) 24.59 percent
- (c) 25.77 percent
- (d) 31.60 percent

Q120. A tent is to be built in the form of a cylinder of radius 10 m surmounted by a cone of the same radius. If the height of the cylindrical part is 5 m and slant height of the conical part is 15 m, how much canvas will be required to build the tent? Allow 20% extra canvas for folding and stitching. (Take $\pi = 22/7$)

- (a) 4714.43 sq m
- (b) 3772.14 sq m
- (c) 6783.86 sq m
- (d) 942.8 sq m

Q121. 7 hrs after a goods train passed a station, another train travelling at a speed of 54 km/hr following that goods train passed through that station. If after passing the station the train overtakes the goods train in 11 hours. What is the speed of the goods train?

- (a) 39.6 km/hr
- (b) 49.5 km/hr
- (c) 33 km/hr
- (d) 26.4 km/hr

Q122. Find two numbers whose sum is 29 and the product is 100.

- (a) 20, 5
- (b) 20, 9
- (c) 25, 4
- (d) 10, 10

Q123. $6.651 - (148.6 - x) - 57.22 = 6.098$. Find x.

- (a) 205.267
- (b) 90.827
- (c) 91.933
- (d) 218.569

Q124. A laborer can do a job in 50 hours. After 5 hours he takes a break. What fraction of the job is yet to be done?

- (a) 0.8
- (b) 0.5
- (c) 0.75
- (d) 0.9

Q125. In an army selection process, the ratio of selected to unselected candidates was 6:1. If 30 less had applied and 10 less selected, the ratio of selected to unselected would have been 7:1. How many candidates had applied for the process?

- (a) 910
- (b) 1820
- (c) 455
- (d) 2730

Q126. A wholesaler sells a watch to a retailer at a gain of 32% and the retailer sells it to a customer at a loss of 20%. If the customer pays Rs 1,953.6, what had it cost the wholesaler?

- (a) Rs 2063
- (b) Rs 2394
- (c) Rs 1850
- (d) Rs 1637

Q127. In the first 39 overs of a cricket match, the run rate was 4.6 runs/over. Calculate the required run rate in the remaining 11 overs to reach the target of 252 runs?

- (a) 7.2
- (b) 6.6
- (c) 7.8
- (d) 6

Q128. Simple interest on a certain sum of money for 3 years at 8% per annum is half the compound interest on Rs 1200 for 2 years at 10% per annum. The sum placed on simple interest is

- (a) Rs 525
- (b) Rs 1050
- (c) Rs 260
- (d) Rs 420

Q129. A vendor buys chikoos at 15 for Rs 8 and then sells at 10 for Rs 6. What will be the result?

- (a) 12.5 percent loss
- (b) 11.11 percent gain
- (c) 12.5 percent gain
- (d) 11.1 percent loss

Q130. A student multiplied a number by $4/5$ instead of $5/4$. What is the percentage error in the calculation?

- (a) 56.25 percent
- (b) 18 percent
- (c) 28.13 percent
- (d) 36 percent



Solutions

S1. Ans.(b)

Sol. Interest of one year = 2448 - 2286 = 162

Interest of three year = 162 × 3 = 486

Principal = 2286 - 486 = 1800

Rate % = $\frac{162}{1800} \times 100 = 9\%$

S2. Ans.(d)

Sol. Selling price of fan = 4644

Profit % = 29%

We have, 129 units = 4644

∴ 100 units = CP of Fan = $\frac{4644}{129} \times 100 = \text{Rs. } 3600$

S3. Ans.(a)

Sol. $30\% = \frac{3}{10}$

Mark price = selling price + Discount

= 744 + 36 = Rs. 780

We have, 13 unit = Rs.780

∴ 10 unit = cost price = $\frac{780}{13} \times 10 = \text{Rs. } 600$

Profit% = $\frac{744-600}{600} \times 100$

= $\frac{144}{600} \times 100 = 24\%$

S4. Ans.(b)

Sol. Total work = days × efficiency

= 30 × 47

U alone can complete the work = $\frac{30 \times 47}{12} = \frac{235}{2}$ days.

S5. Ans.(b)

Sol. Time = $\frac{\text{Distance}}{\text{speed}} = \frac{2275}{90 \times \frac{5}{18}} = 91 \text{ sec.}$

S6. Ans.(c)

Sol. Let length = 10 cm & breadth = 10 cm

Area = 100 cm²

New length = $\frac{10 \times 140}{100} = 14 \text{ cm}$

New breadth = $\frac{10 \times 170}{100} = 17 \text{ cm}$

New area = 238 cm²

Required percentage increase = $\frac{238-100}{100} \times 100 = 138\%$

S7. Ans.(b)

Sol. Profit share Ratio is equal to investment ratio if time of investment is equal or not given profit share ratio

| | |
|--------|--------|
| u | v |
| 184000 | 224000 |
| 23 | 28 |

Required total profit = $\frac{20700 \times (23+28)}{23} = 45900$

S8. Ans.(c)

Sol. ATQ,

$$\frac{61681^2 - 31681^2}{30000} = \frac{(61681 + 31681)(61681 - 31681)}{30000}$$

= 93362

S9. Ans.(d)

Sol. Total market price = 520 + 40 = 560

Let, cost price = x

Market price = $\frac{x \times 140}{100} = 1.4x$

1.4x = 560

x = 400

Selling price = 520

Profit = 520 - 400 = 120

Required profit percentage = $\frac{120}{400} \times 100 = 30\%$

S10. Ans.(c)

Sol. In 1st statement

$$2\sqrt{3} > 3\sqrt{2}$$

If we make square we get $12 > 18$

So, 1st statement is wrong.

In 2nd statement

$$4\sqrt{2} > 2 \times 2\sqrt{2} = 4\sqrt{2} = 4\sqrt{2}$$

So, 2nd statement is also wrong.

Both statements are wrong.

S11. Ans.(d)

Sol. $1260 \frac{\text{km}}{\text{hr}} = 1260 \times \frac{5}{18} \text{ m/s}$

= 350 m/s

S12. Ans.(c)

Sol. CP of 1 kg of almond

= $1250 \times \frac{100}{93} = \text{Rs. } 1344$

Now, on selling it for Rs. 1375

P = $\frac{1375-1344}{1344} \times 100$

= 2.3%

S13. Ans.(c)

Sol.

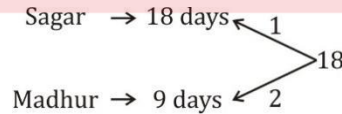

No. of days to complete the work together

= $\frac{18}{1+2} = 6 \text{ days}$

S14. Ans.(a)

Sol. Increase in fare = $\frac{550}{11} \times 7$

= Rs. 350

S15. Ans.(a)

Sol. $(x+y)^2 = x^2 + y^2 + 2xy$

$$(x+y)^2 = 100 + 2 \times 22$$

$$(x+y)^2 = 144$$

$$x+y = \sqrt{144} = 12$$

S16. Ans.(c)

Sol. Let the marks score by two students be x , $(x + 20)$
ATQ,

$$(x + 20) = \frac{55}{100}(x + x + 20)$$

$$\Rightarrow x = 90$$

So, marks obtained by two students are 90, 110.

S17. Ans.(c)

Sol. Effective discount = $D_1 + D_2 - \frac{D_1 \times D_2}{100}$

$$= 25 + 8 - \frac{25 \times 8}{100}$$

$$= 31\%$$

S18. Ans.(c)

Sol.

Prabhat --- 24 days

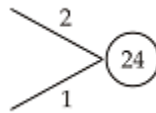

Santosh --- 12 days

No. of days required to complete the work together
 $= \frac{24}{1+2} = 8$ days

S19. Ans.(c)

Sol. ATQ,

$$\frac{x}{y} = \frac{y}{128} \Rightarrow y^2 = 128x \quad \dots (i)$$

And,

$$\sqrt{xy} = 16 \Rightarrow xy = 256 \quad \dots (ii)$$

From (i) & (ii)

$$x = 8 \text{ \& } y = 32$$

S20. Ans.(d)

Sol. Total runs made till 32 overs = 32×7.2
 $= 230.4$ runs
 Remaining runs to be made = $297 - 230.4$
 $= 66.6$ runs
 \therefore Required run rate = $\frac{66.6}{18} = 3.7$

S21. Ans.(d)

Sol. Let the sum be $100x$.

$$CI \text{ for } 2 \text{ years at } 16\% = 34.56x$$

$$SI \text{ for } 2 \text{ years at } 16\% = 32x$$

$$CI - SI = 320$$

$$2.56x = 320$$

$$x = 125$$

$$\text{Sum} = \text{Rs. } 12500$$

S22. Ans.(b)

Sol. Let the no. be a, b, c, d, e .

ATQ,

$$a + b + c + d + e = 76 \times 5 = 380$$

$$\& a = \frac{3}{7}(b + c + d + e)$$

$$\Rightarrow a + \frac{7}{3}a = 380$$

$$a = 114$$

S23. Ans.(b)

Sol. ATQ,

$$36 - 16x - 4x + 8 = 4$$

$$x = 2$$

S24. Ans.(b)

Sol. 1 items selling price = $400 - 24 = 376$

4 items selling price = $1600 - (16 \times 24) = 1216$

5 items selling price = $1216 + 376 = 1592$

$$\text{Effective discount} = \frac{(2000 - 1592)}{2000} \times 100 = 20.4\%$$

S25. Ans.(d)

Sol. $(200000 - 6) \times (200000 + 6)$

$$= (200000)^2 - (6)^2$$

$$= 39999999964$$

S26. Ans.(d)

Sol. $0.77777 + 0.7777 + 0.777 + 0.77 + 0.7 + 0.07$
 $= 3.87247$

S27. Ans.(b)

Sol. Total unusual eggs = 10

\therefore Total rotten eggs = 16

& total number of eggs = $25 \times 16 = 400$

S28. Ans.(d)

Sol. $X : Y : Z = \frac{1}{3} : \frac{1}{4} : \frac{1}{2} = 4 : 3 : 6$

$$\Rightarrow X : Y : Z = 4 : 3 : 6$$

We have

$$13 \text{ units} = 18200$$

$$\therefore 4 \text{ units} = \frac{18200}{13} \times 4 = 5600$$

S29. Ans.(a)

Sol.

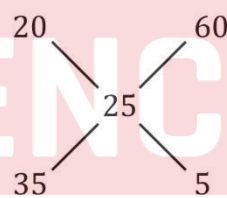

Req. ratio = 7 : 1

S30. Ans.(b)

Sol. Sum of first 39 even numbers

$$2 + 4 + 6 + \dots$$

It is an A.P. where,

$$a = 2, d = 2, n = 39$$

$$S_n = \frac{n}{2}[2a + (n-1).d]$$

$$\Rightarrow S_{39} = \frac{39}{2}[2 \times 2 + 38 \times 2] = 39 \times 40$$

$$\text{Avg. of first 39 even numbers} = \frac{39 \times 40}{39} = 40$$

S31. Ans.(c)

Sol. We have, $31x + 31y = 403$

$$\Rightarrow x + y = 13$$

$$\text{Avg. of } x \text{ \& } y = \frac{x+y}{2} = \frac{13}{2} = 6.5$$

S32. Ans.(d)

Sol. We have,

$$\frac{x \times 12 \times 1}{100} = \frac{(7500 - x) \times 18 \times 1}{100}$$

$$2x = 22500 - 3x$$

$$\Rightarrow x = 4500$$

$$\therefore \text{Required interest} = \frac{4500 \times 12 \times 1}{100} = \text{Rs. } 540$$

S33. Ans.(b)

Sol. Profit percentage = 18% = $\frac{9}{50}$

$$CP = \frac{13924}{59} \times 50 = 11,800$$

$$\text{Req. loss \%} = \frac{11800 - 10266}{11,800} \times 100 = 13\%$$

S34. Ans.(b)

Sol. We know that

$$CP \qquad \qquad \qquad MRP$$

$$100 - D \qquad \qquad 100 + P$$

$$55 \qquad : \qquad 121$$

$$\text{Req. \%} = \frac{66}{55} \times 100 = 120\%$$

S35. Ans.(a)

$$\text{Sol.} = \sqrt{513 - \sqrt{144} - \sqrt{81} - \sqrt{64}} = \sqrt{513 - 12 - 9 - 8} = \sqrt{484} = 22$$

S36. Ans.(c)

Sol.

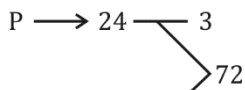

Tap Q works for 15 hrs.
In 15 hours it will fill $15 \times 4 = 60$ liters

$$\text{Remaining} = 72 - 60 = 12$$

It at 11 am + 4 hrs = 3pm tap P should be closed

S37. Ans.(a)

Sol. We have,

$$S \rightarrow 4 : 5$$

$$T \rightarrow 5 : 4$$

$$1 \text{ unit} = 6 + 6 = 12 \text{ min.}$$

$$5 \text{ unit} = 5 \times 12 = 60 \text{ min.}$$

$$\text{Distance} = \text{Speed} \times \text{Time} = 4 \times 1 = 4 \text{ km}$$

S38. Ans.(a)

Sol. Weight of P and Q = $2 \times 38 = 76$ kg

Weight of P, Q and Coach (T) = $3 \times 49 = 147$ kg

Now,

$$\text{Weight of coach (T)} = 147 - 76$$

$$= 71 \text{ kg}$$

S39. Ans.(a)

$$\text{Sol. } R = \frac{540 \times 100}{1200 \times 3} = 15\%$$

$$\text{New rate} = (15 + 3) = 18\%$$

So,

$$SI = \frac{1200 \times 18 \times 3}{100} = \text{Rs } 648$$

$$\text{Amount} = 1200 + 648 = \text{Rs. } 1848$$

S40. Ans.(c)

Sol. SP = 100 (let)

$$CP = 75$$

$$\text{Profit} = 100 - 75 = 25$$

$$P\% = \frac{25}{75} \times 100$$

$$= 33.33\%$$

S41. Ans.(c).

Sol.

$$\text{Total age of family of 6 members} = 25 \times 6 + 4 \times 6 = 174$$

$$\text{Total age of family of 7 members} = 25 \times 7 = 175$$

$$\text{So, present age of child} = 175 - 174 = 1 \text{ year}$$

S42. Ans.(c)

Sol.

$$I + II + III = 83 \times 3 = 249$$

$$III + IV + V = 97 \times 3 = 291$$

$$I \text{ to } V = 92 \times 5 = 460$$

S43. Ans.(c)

Sol.

Let his salary is 100

$$\text{He spends } \frac{3}{4} \times 100 = 75$$

His savings is 25

Now increased salary = 120

$$\text{New expenditure} = 75 + 75 \times \frac{10}{100} = 82.5$$

$$\text{Now savings} = 120 - 82.5 = 37.5$$

$$\text{Percentage increment in saving} = \frac{37.5 - 25}{25} \times 100 = \frac{12.5}{25} \times 100 = 50\%$$

S44. Ans.(d)

Sol.

Let y's salary = 100

$$\text{So x's salary} = 100 \times \frac{80}{100} = 80$$

y's salary is greater than x by 20

$$\text{In percentage} = \frac{\text{difference in salary}}{x' \text{ salary}} \times 100$$

$$= \frac{20}{80} \times 100 = 25\%$$

S45. Ans.(d)

Sol.

According to question given,

$$\frac{x}{100} \times 2000 + \frac{y}{100} \times 2000 = 700 \quad \dots (1)$$

$$\frac{x}{100} \times 2000 + \frac{y}{100} \times 3000 = 900 \quad \dots (2)$$

From (1) and (2)

$$x = 15\%$$

$$y = 20\%$$

$$\Rightarrow \frac{15}{100} \times 2000 + \frac{20}{100} \times 9000 = 2100 \text{ Rs.}$$

S46. Ans.(a)

Sol.

Here, $a = 8, b = 21, c = 13$ and $d = 31$.

$$\therefore \text{The required number} = \frac{bc-ad}{(a+d)-(b+c)}$$

$$= \frac{21 \times 13 - 8 \times 31}{(8+31)-(21+13)} = 5.$$

S47. Ans.(b)

Sol.

We have, $a : b = 3 : 2, c : d = 5 : 3$ and $S = 1000$

$$\therefore A's \text{ income} = \frac{aS(d-c)}{ad-bc}$$

$$= \frac{3 \times 1000 \times (3-5)}{(3 \times 3 - 2 \times 5)}$$

$$= \text{Rs. } 6000.$$

S48. Ans.(a)

Sol.

| | A | B | C |
|--------------------|-------------------------|--------------------------|-------------------------|
| Present students = | 6x | 8x | 7x |
| New strength = | $6 \times 1.2x$ 7.2x | $8 \times 1.15x$ 9.2x | $7 \times 1.2x$ 8.4x |
| New ratio = | 72 | 92 | 84 |
| | 18 | 23 | 21 |

S49. Ans.(c)

Sol.

Let A paid = Rs x

$$120\% \text{ of } 125\% \text{ of } x = 450 \Rightarrow \frac{120}{100} \times \frac{125}{100} \times x = 450$$

$$\Rightarrow x = \text{Rs } 300$$

S50. Ans.(d)

Sol.

$$C.P. = \text{Rs. } \left(\frac{100}{105} \times 630000 \right) = \text{Rs. } 600000.$$

$$\therefore \text{Required loss\%} = \left(\frac{100000}{600000} \times 100 \right) \% = 16\frac{2}{3}\%$$

S51. Ans.(d)

Sol. CP: MP

$$= (100 - D) : (100 - L)$$

$$= (100 - 20) : (100 - 16)$$

$$= 80 : 84$$

Or, CP: MP = 20: 21

Let the CP = 20x & MP = 21x

Now, 10% discount

$$SP = 18.9x$$

$$\text{Loss\%} = \frac{20x - 18.9x}{20x} = 5.5\%$$

S52. Ans.(b)

Sol. All the prime number between 30 and 42 are 31, 37, 41

$$\text{Sum} = 31+37+41 = 109$$

S53. Ans.(c)

Sol. ATQ

$$12 - 6x = 4x + 2$$

$$x = 1$$

S54. Ans.(a)

Sol. Let speed of express train = x km/hr
& speed of Rajdhani = y km/hr

ATQ,

$$\frac{816}{x} - \frac{816}{y} = 9 \quad \dots(i)$$

And,

$$\frac{816}{y} - \frac{816}{2x} = 4 \quad \dots(ii)$$

Add (i) & (ii)

$$\frac{816}{x} - \frac{816}{2x} = 13$$

$$x = 31.38 \text{ km/hr}$$

By putting value of x in (i) or (ii)

$$y = 48 \text{ km/hr}$$

S55. Ans.(d)

Sol. $4pxy = (x + 2y)^2 - (x - 2y)^2$

$$4pxy = [x^2 + 4y^2 + 4xy] - [x^2 + 4y^2 - 4xy]$$

$$4pxy = 8xy$$

$$p = 2$$

S56. Ans.(b)

Sol. Runs scored till 26 overs = 26×5.4

$$= 140.4 \text{ runs}$$

Runs to be made in last 24 overs = $(294 - 140.4)$ runs

$$\therefore \text{Required Run rate} = \frac{153.6}{24} = 6.4 \text{ runs/over}$$

S57. Ans.(c)

Sol. $a + b = 29$

$$ab = 100 \Rightarrow a = \frac{100}{b}$$

$$\frac{100}{b} + b = 29$$

$$b^2 - 29b + 100 = 0$$

$$b = 25, 4$$

Hence, the two numbers are 4, 25.

S58. Ans.(d)

Sol. Let the total work be 100 unit

$$\text{Work/hour} = \frac{100}{50} \text{ unit} = 2 \text{ unit}$$

Work done in 5 hour = 10 unit

Remaining work = 90 unit

$$\text{Fraction of remaining work} = \frac{90}{100}$$

$$= 0.90$$

S59. Ans.(a)

Sol. Let the no. of selected & non-selected candidates be 6x, x respectively.

ATQ,

$$\frac{6x-10}{x-20} = \frac{7}{1}$$

$$x = 130$$

$$\text{No. of candidate applied} = 7x = 910$$

S60. Ans.(b)

Sol. Total amount to be paid without discount = $1600 \times 23 + 1200 \times 10 = 48,800$

ATQ,

10 children can get free ticket with 20 Adult, so all the children will get free tickets

\therefore Total discount = $1200 \times 10 = \text{Rs. } 12000$

$$\% \text{ Discount} = \frac{12000}{48800} \times 100 = 24.59\%$$

S61. Ans.(c)

Sol. Let the SP of 1 watch be Rs 1

SP of 17 Omega watches = Rs 17

Profit = Rs 7 (i.e. SP of 7 watches)

\therefore CP = Rs (17 - 7) = Rs 10

$$\text{Profit \%} = \frac{7}{10} \times 100 = 70\%$$

S62. Ans.(a)

$$\begin{aligned} \text{Sol. Required avg. marks} &= \frac{(30 \times 67 + 55 \times 63 + 40 \times 61)}{(30 + 55 + 40)} \\ &= \frac{2010 + 3465 + 2440}{125} \\ &= 63.32 \end{aligned}$$

S63. Ans.(a)

Sol. ATQ,

$$\frac{73205}{50000} = \left(1 + \frac{R}{100}\right)^2$$

$$\sqrt{\frac{14641}{10000}} = \left(1 + \frac{R}{100}\right)$$

$$\frac{121}{100} - 1 = \frac{R}{100} \Rightarrow R = 21\%$$

S64. Ans.(c)

Sol. Let the no. of 1 rupee, 50 paise and 10 paise coins be 6x,

3x & 2x

ATQ,

$$6x + \frac{3x}{2} + \frac{2x}{10} = 308$$

$$\Rightarrow x = 4$$

No. of 50 paise coins = $3 \times 4 = 12$

S65. Ans.(a)

Sol. Let the marks scored by them are x & (x + 13)

ATQ,

$$(x + 13) = \frac{76}{100} (x + x + 13)$$

$$x = 6$$

So, the marks obtained by two students are 6 and 19.

S66. Ans.(b)

Sol. 1044 is the nearest multiple of 29 to 1039. Hence 5 is the least no. to be added to 1039 to make the sum completely divisible by 29.

S67. Ans.(a)

Sol. Let the MP be 100x

SP at 4% discount = 96x

CP at 10% loss = $\frac{320}{3}x$

New SP at 20% discount = 80x

$$\text{Loss} = \frac{\frac{320}{3}x - 80x}{\frac{320}{3}x} \times 100 = 25\%$$

S68. Ans.(b)

Sol. ATQ,

$$8(CP - 51) = (60 - CP)$$

$$9CP = 468$$

$$CP = 52 \text{ lakhs}$$

S69. Ans.(c)

Sol. Let the sum be 100x

S.I. at 12% for 2 years = 24x

C.I. at 12% for 2 years = 25.44x

$$C.I. - S.I. = 1.44x = 72$$

$$\Rightarrow x = 50$$

Sum = Rs. 5000

S70. Ans.(c)

Sol. According to the question,

$$S + G + R = 97 \times 3 = 291 \text{ kg}$$

$$S + G = 93 \times 2 = 186 \text{ kg}$$

$$\Rightarrow R = 291 - 186 = 105 \text{ kg.}$$

$$\& G + R = 82 \times 2 = 164 \text{ kg}$$

$$\Rightarrow \text{Gopesh weight (G)} = 164 - 105 = 59 \text{ kg}$$

S71. Ans.(b)

Sol. We have, $10\% = \frac{1}{10}$

$$\frac{10}{100} \frac{11}{121}$$

$$\Rightarrow 100 \text{ unit} = 300000$$

$$\therefore 121 \text{ unit} = \frac{300000}{100} \times 121 = 363000$$

S72. Ans.(c)

Sol. We have

$$\frac{2x - 7000}{3x - 15000} = \frac{3}{2}$$

$$\Rightarrow 4x - 14000 = 9x - 45000$$

$$\Rightarrow 5x = 31000$$

$$\text{or } x = 6200$$

$$\therefore \text{Income of X (in Rs.)} = 2x = 2 \times 6200 = \text{Rs. } 12400$$

S73. Ans.(a)

Sol. Profit ratio = Investment \times time

$$X : Y = 40,000 \times 2 : 50,000 \times \frac{3}{2}$$

$$= 16 : 15$$

S74. Ans.(c)

Sol. Sum of all two digit numbers

$$10 + 11 + 12 + 13 + \dots + 99.$$

$$\text{sum of } n \text{ terms in AP} = \frac{n\{2a + (n-1)d\}}{2};$$

n = number of terms

a = first terms

d = difference of two consecutive terms

$$= \frac{90\{2 \times 10 + (90-1)1\}}{2} = \frac{90 \times 109}{2}$$

$$\text{Avg} = \frac{90 \times 54.5}{90} = 54.5$$

S75. Ans.(c)

Sol. Simple interest of 6 years = 3600

\therefore Simple interest of 1 years = 600

$$\text{Rate of interest} = \frac{600}{6000} \times 100 = 10\%$$

S76. Ans.(a)

Sol. 100% = 6000

$$\therefore 75\% = \frac{6000}{100} \times 75 = 4500$$

S77. Ans.(b)

Sol. Let CP = 100

$$\therefore MP = 140$$

We have, 140 = Rs. 420

$$\therefore CP = \text{Rs. } 300$$

$$\text{Profit \%} = \frac{400 - 300}{300} \times 100 = \frac{100}{3} = 33\frac{1}{3}\%$$

S78. Ans.(c)

$$\text{Sol. } \frac{\sqrt{32} + \sqrt{72}}{\sqrt{8}} = \frac{4\sqrt{2} + 6\sqrt{2}}{2\sqrt{2}} = 5$$

S79. Ans.(c)

Sol.

$$A : B : C$$

$$E \rightarrow 15 : 10 : 6$$

We have, Total work = Efficiency \times time
= 31 \times 15

$$C \text{ can complete the same work in}$$

$$= \frac{31 \times 15}{6} = \frac{465}{6}$$

S80. Ans.(c)

$$\text{Sol. } S = \frac{D}{T}$$

$$S = \frac{500}{50} = 10 \text{ m/s} = 10 \times \frac{18}{5} = 36 \text{ km/hr}$$

S81. Ans.(a)

$$\text{Sol. } \sqrt[3]{\frac{4096}{1728}} = \sqrt[3]{\frac{16 \times 16 \times 16}{12 \times 12 \times 12}} = \frac{16}{12} = \frac{4}{3}$$

S82. Ans.(b)

Sol. Let the numbers, a & 25 - a

ATQ,

$$\Rightarrow a^2 + (25-a)^2 = 373$$

$$\Rightarrow a^2 + 625 + a^2 - 50a = 373$$

$$\Rightarrow 2a^2 - 50a + 252 = 0$$

$$\Rightarrow a^2 - 25a + 126 = 0$$

$$\Rightarrow a^2 - 18a - 7a + 126 = 0$$

$$\Rightarrow a(a-18) - 7(a-18) = 0$$

$$\Rightarrow (a-18)(a-7) = 0$$

$$a = 18, 7$$

Required number are, a = 18 & 25 - a = 7

S83. Ans.(d)

$$\text{Sol. Given expression} = \frac{(0.94)^3 + (0.1)^3}{(0.94)^2 - 0.094 + (0.1)^2}$$

$$= \left(\frac{a^3 + b^3}{a^2 - ab + b^2} \right) = \left(\frac{(a+b)(a^2 - ab + b^2)}{a^2 - ab + b^2} \right)$$

$$= (a + b)$$

$$= (0.94 + 0.1) = 1.04$$

S84. Ans.(d)

$$\text{Sol. } 7.\overline{47} = 7 + 0.\overline{47}$$

$$= 7 + \frac{47}{99} = \frac{693 + 47}{99} = \frac{740}{99}$$

S85. Ans.(d)

$$\text{Sol. } 0.66666 + 0.6666 + 0.666 + 0.66 + 0.6 + 0.06$$

$$= 3.31926$$

S86. Ans.(b)

Sol. From,

$$2x - 1 < 5x + 2$$

$$\Rightarrow -1 < x \quad \dots(i)$$

$$\text{From, } 2x + 5 < 6 - 3x$$

$$\Rightarrow x < \frac{1}{5} \quad \dots(ii)$$

From (i) & (ii) only option (b) satisfy the equations.

S87. Ans.(c)

Sol. Let the total work be 100 units, which he does in 60 hours

$$\Rightarrow 60 \text{ hours} \rightarrow 100\text{-unit work}$$

$$1 \text{ hour} \rightarrow 5/3\text{-unit work}$$

$$15 \text{ hours} \rightarrow 25\text{-unit work}$$

$$\text{Remaining work} = (100 - 25) \text{ unit work}$$

$$= 75\text{-unit work}$$

$$\text{Fraction of remaining work} = \frac{75}{100} = 0.75$$

S88. Ans.(c)

Sol. Let the principle be 100 (at SI)

$$\therefore \text{Amount after 5 years} = 175$$

$$SI = \frac{P \times R \times T}{100}$$

$$(175 - 100) = \frac{100 \times R \times 5}{100}$$

$$R = 15\%$$

Now,

$$CI = \text{Amount} - \text{Principal}$$

$$= P \left(1 + \frac{R}{100} \right)^t - P$$

$$= 40000 \left(1 + \frac{15}{100} \right)^2 - 40,000$$

$$= \text{Rs } 12,900$$

S89. Ans.(a)

Sol. According to question

$$7(\text{CP} - 50 \text{ Lakh}) = (60 \text{ lakh} - \text{CP})$$

$$\Rightarrow \text{CP} = 51.25 \text{ lakhs}$$

S90. Ans.(a)

$$\text{Sol. } \frac{\text{Girish's salary}}{\text{Hariram's salary}} = \frac{11}{7} = \frac{44}{28}$$

$$\frac{\text{Shekher's Salary}}{\text{Hariram's salary}} = \frac{3}{4} = \frac{21}{28}$$

By making Hariram's salary constant, we get the ratio as Girish's and Shikhar's salary ratio i.e. 44: 21

S91. Ans.(c)

Sol. Let the required number = x

ATQ,

$$x - 49 = 95 - x$$

$$2x = 144$$

$$x = 72$$

S92. Ans.(b)

Sol. We have, $F = A + S = \frac{1}{5} + \frac{1}{10} + \frac{1}{4} = \frac{11}{20}$

Remaining Rs. in his wallet = $\frac{9}{20} = 1800$

$1 = 4000$

$A + S = \frac{1}{10} + \frac{1}{4} = 4000 \times \frac{7}{20} = \text{Rs. } 1400$

S93. Ans.(a)

Sol. We have, $P = 350$ & $Q = 600$

Req. percentage = $\frac{600-350}{600} = \frac{250}{600} \times 100$

= 41.66%

S94. Ans.(b)

Sol. Let the numbers are $5x$ & $4x$.

ATQ,

$5x + 4x = 180$

$9x = 180$

$x = 20$

Smaller number = $4x = 4 \times 20 = 80$

S95. Ans.(c)

Sol. Profit Ratio = Investment \times time

Profit Ratio = $35000 \times 2 : 21000 \times 1$

= 10: 3

We have 13 unit = 26000

P's share = 10 unit = $\frac{26000}{13} \times 10 = 20,000$ Rs.

S96. Ans.(b)

Sol. $\frac{24a^2b^2}{6b^2} = 4a^2$

S97. Ans.(a)

Sol. Let the speed of express train and Rajdhani be x km/h & y km/hr respectively.

ATQ,

$\frac{612}{x} - \frac{612}{y} = 9$... (i)

And,

$\frac{612}{y} - \frac{612}{2x} = 3$... (ii)

Adding (i) and (ii)

$\frac{612}{x} - \frac{612}{2x} = 12$

$\Rightarrow x = 25.5$ km/h

From (i),

$\Rightarrow y = 40.8$ km/hr

S98. Ans.(b)

Sol. Let the efficiency of Pradeep & Saquib be P & S respectively.

ATQ,

$\frac{P \times 14}{1/4} = \frac{S \times 56}{3/4}$

$\Rightarrow \frac{P}{S} = \frac{4}{3}$

Total work = $\frac{4 \times 14}{\frac{1}{4}}$ or $\frac{3 \times 56}{\frac{3}{4}}$

= 224 units

Time taken by both to complete the whole work together

= $\frac{224}{4+3} = 32$ days

S99. Ans.(a)

Sol. Let the two consecutive natural numbers be $x, (x + 1)$

ATQ,

$x^2 + (x + 1)^2 = 145$

$x^2 + x - 72 = 0$

$x = 8$

\therefore Two numbers are 8 and 9

S100. Ans.(b)

Sol. $8Z = 8 \times 10 + Z$

= $80 + Z$

S101. Ans.(b)

Sol.

J W

$A \rightarrow 5 : 1 = 6 \dots$ (i)

$B \rightarrow 5 : 7 = 12 \dots$ (ii)

Eqn. (i) $\times 2 +$ Eqn. (ii)

J W

15 : 9

5 : 3

S102. Ans.(d)

Sol.

A T

I $4 : 5 = 9 \dots$ (i)

II $4 : 7 = 11 \dots$ (ii)

Eqn. (i) $\times 11 +$ Eqn. (ii) $\times 9$

A T

80 : 118

40 : 59

S103. Ans.(d)

Sol. Avg. weight of first three bags = 19 kg

Sum of weight of four bags = $19 \times 3 + 22 = 79$ kg.

Avg. weight of last three bags = 18 kg

Sum of weight of three bags = 54 kg

\therefore Weight of first bag = $79 - 54 = 25$ kg

S104. Ans.(a)

Sol. Let P be the principal

$8800 - P = \frac{P \times 25 \times 4}{100}$

$\Rightarrow P = \text{Rs. } 4400$

S105. Ans.(c)

Sol. $CP = 360$

Profit % = 32% = $\frac{8}{25}$

$\frac{CP}{SP} = \frac{25}{33}$

$SP = \frac{360}{25} \times 33 = 475.2$

Profit = $SP - CP$

= $475.2 - 360$

= Rs. 115.2

S106. Ans.(a)

Sol. We have, $20\% = \frac{1}{5}$ & $5\% = \frac{1}{20}$

$$\begin{array}{r} 5 \quad 4 \\ \hline 20 \quad 19 \end{array}$$

$$100 \quad 76$$

$$100 \text{ unit} = 450$$

$$76 \text{ unit} = \frac{450}{100} \times 76 = 342$$

S107. Ans.(a)

Sol. $\sqrt{2^6 + 15^2} = \sqrt{64 + 225} = \sqrt{289} = 17$

S108. Ans.(c)

Sol. We have

$$M_1 D_1 = D_2 D_2$$

ATQ,

$$18 \times 24 = 12 \times 18 + x \times 12$$

$$18(24 - 12) = 12x$$

$$x = 18$$

S109. Ans.(a)

Sol. Both trains are moving in same direction

$$\therefore \text{Relative speed} = 84 - 42 = 42 \text{ km/hr}$$

$$\text{Required time} = \frac{(320+380) \times 18}{42 \times 5} = 60 \text{ seconds}$$

S110. Ans.(d)

Sol. We have,

$$4\sqrt{3} > 3\sqrt{4}$$

$$4 \times 1.73 > 3 \times 2$$

$$6.92 > 6$$

\therefore Statement I is true

$$\text{And } 8\sqrt{2} > 2\sqrt{8}$$

$$8\sqrt{2} > 2.2\sqrt{2}$$

$$8\sqrt{2} > 4\sqrt{2}$$

\therefore Statement II is true.

S111. Ans.(b)

Sol. A prime number can be divided, without a remainder, only by itself and by 1. Out of the given options 87 does not full fill these conditions. It can be divided by 3 as well 29. Hence 87 is not a prime number.

S112. Ans.(c)

Sol. $\sqrt{2}, \sqrt[3]{3}, \sqrt{4}, \sqrt[3]{5}$

$$= 2^{\frac{1}{2}}, 3^{\frac{1}{3}}, 2, 5^{\frac{1}{3}}$$

$$= 2^3, 3^2, 2^6, 5^2$$

$$= 8, 9, 64, 25$$

$\Rightarrow \sqrt{4}$ is largest number.

S113. Ans.(b)

Sol. $13 \times 49^{\frac{3}{2}} = 13 \times 7^{2 \times \frac{3}{2}} = 13 \times (7)^3$

$$= 13 \times 343$$

$$= 4459$$

S114. Ans.(b)

Sol. We have,

$$a + b = 8$$

$$a - b = 2$$

Solving, we get, $a = 5, b = 3$.

$$\text{Now, } \frac{a^2+b^2}{a^3-b^3} = \frac{25+9}{125-27} = \frac{34}{98} = \frac{17}{49} = 0.347$$

S115. Ans.(a)

Sol. Let the first & second part of the number is A & B respectively

ATQ

Case (i)

$$\frac{30A}{100} - \frac{20B}{100} = 25$$

$$3A - 2B = 250 \dots (i)$$

Case (ii)

$$\frac{50B}{100} - \frac{60A}{100} = 33.5$$

$$5B - 6A = 335 \dots (ii)$$

From eqn. (i) & (ii) $A = 640$ & $B = 835$.

Hence, required number = $A + B$

$$= 640 + 835$$

$$= 1475$$

S116. Ans.(c)

Sol. Let the price of the article be 100

\therefore Reduced price = 97

$$\% \text{ increase to restore to its original price} = \frac{100-97}{97} \times 100 =$$

$$3.09\%$$

S117. Ans.(c)

$$\text{Sol. CI} = P \left[\left(1 + \frac{R}{100} \right)^t - 1 \right]$$

$$= 16000 \left[\left(1 + \frac{10}{100} \right)^2 - 1 \right]$$

$$= \text{Rs. } 3360$$

ATQ,

$$SI = \frac{1}{2} \times \text{Rs. } 3360 = 1680$$

$$1680 = \frac{P \times 8 \times 3}{100}$$

$$P = \text{Rs. } 7000$$

S118. Ans.(a)

$$\text{Sol. } \frac{144 a^3 b^3 c^3}{24 b^2 c}$$

$$= 6a^3 bc^2$$

S119. Ans.(b)

Sol. Total amount to be paid without discount = $1600 \times 23 + 1200 \times 10 = 48,800$

ATQ,

10 children can get free ticket with 20 Adult, so all the children will get free tickets

$$\therefore \text{Total discount} = 1200 \times 10 = \text{Rs. } 12000$$

$$\% \text{ Discount} = \frac{12000}{48800} \times 100$$

$$= 24.59\%$$

S120. Ans.(d)

Sol. Total curved S. Area = $2\pi rh + \pi r\ell$
 $= 2 \times \frac{22}{7} \times 10 \times 5 + \frac{22}{7} \times 10 \times 15 = \frac{5500}{7}$

As 20% extra is required

∴ Total canvas Required

$$= \frac{5500}{7} \times \frac{120}{100}$$

$$= 942.8 \text{ m}^2$$

S121. Ans.(c)

Sol. ATQ,

Distance travel by Goods train in 11 hours is equal to the distance travel by other train in 18 hours.

$$\therefore 11 \times 54 = 18 \times x$$

$$\Rightarrow x = 33 \text{ km/hr}$$

S122. Ans.(c)

Sol. $a + b = 29$

$$ab = 100 \Rightarrow a = \frac{100}{b}$$

$$\frac{100}{b} + b = 29$$

$$b^2 - 29b + 100 = 0$$

$$b = 25, 4$$

Hence, the two numbers are 4, 25.

S123. Ans.(a)

Sol. $6.651 - (148.6 - x) - 57.22 = 6.098$

$$x = [6.098 + 57.22 + 148.6 - 6.651]$$

$$x = 205.267$$

S124. Ans.(d)

Sol. Let the total work be 100 unit

$$\text{Work/hour} = \frac{100}{50} \text{ unit} = 2 \text{ unit}$$

Work done in 5 hour = 10 unit

Remaining work = 90 unit

Fraction of remaining work

$$= \frac{90}{100} = 0.90$$

S125. Ans.(a)

Sol. Let the no. of selected & non selected candidates be $6x$, x respectively.

ATQ,

$$\frac{6x - 10}{x - 20} = \frac{7}{1}$$

$$x = 130$$

No. of candidate applied = $7x = 910$

S126. Ans.(c)

Sol. Let the CP of watch for wholeseller be x .

ATQ,

$$x \times \frac{132}{100} \times \frac{80}{100} = 1953.6$$

$$x = \text{Rs. } 1850$$

S127. Ans.(b)

Sol. Runs made till 39 overs = 39×4.6

$$= 179.4 \text{ runs}$$

Runs to be made in last 11 overs

$$= 252 - 179.4$$

$$= 72.6$$

$$\text{Required run rate} = \frac{72.6}{11} = 6.6$$

S128. Ans.(a)

Sol. $CI = P \left[\left(1 + \frac{R}{100} \right)^t - 1 \right]$

$$= 1200 \left[\left(1 + \frac{10}{100} \right)^2 - 1 \right]$$

$$= \text{Rs } 252$$

ATQ,

$$SI = \frac{1}{2} \times 252 = \text{Rs } 126$$

$$\frac{P \times 3 \times 8}{100} = 126 \Rightarrow P = \text{Rs } 525$$

S129. Ans.(c)

Sol. CP of 1 chikoo = $\text{Rs } 8/15 = 0.54$

SP of 1 chikoo = $\text{Rs } 6/10 = \text{Rs } 0.60$

$$P = \frac{0.60 - 0.54}{0.54} \times 100 = 12.5\%$$

S130. Ans.(d)

Sol. Let the no. be $20x$ [LCM of 4 & 5]

$$\text{Wrong multiplication} = 20x \times \frac{4}{5} = 16x$$

$$\text{Right multiplication} = 20x \times \frac{5}{4} = 25x$$

$$\% \text{ error} = \frac{25x - 16x}{25x} \times 100 = 36\%$$



100+ Reasoning MCQs for Defence 2023 Exam

Q1. From the given alternatives, select the word which CANNOT be formed using the letters of the given word.

Information

- (a) From
- (b) Action
- (c) Motion
- (d) Norm

Q2. In a certain code language, "TRUMP" is written as "46321" and "GRAIN" is written as "76598". How is "GRUNT" written in that code language?

- (a) 23684
- (b) 23847
- (c) 67834
- (d) 76384

Q3. In a certain code language, '-' represents 'x', '÷' represents '+', '+' represents '÷' and 'x' represents '-'. Find out the answer to the following question.

$$2 \times 12 \div 32 - 5 + 4 = ?$$

- (a) 17
- (b) 34
- (c) 28
- (d) 30

Q4. The following equation is incorrect. Which two signs should be interchanged to correct the equation?

$$14 + 8 \div 16 - 9 \times 12 = 10$$

- (a) + and ÷
- (b) - and +
- (c) + and x
- (d) ÷ and x

Q5. If $-3\%1 = 3$, $3\%6 = -18$ and $-7\%4 = 28$, then find the value of $-2\%9 = ?$

- (a) 47
- (b) -63
- (c) 18
- (d) -30

Q6. Which of the following terms follows the trend of the given list?

ABABACCB, ABABCCAB, ABACCBAB, ABCCABAB, ACCBABAB,

- (a) ABABABCC
- (b) CCABABAB
- (c) ABABACCB
- (d) ABABCCAB

Q7. A woman while shopping in a mall pushes her trolley 20 metres through an alley which is going East, then she turns to her left and walks 30 metres, then she turns West and walks another 30 metres, then she turns South and walks 30 metres and then she turns West and walks 25 metres. Where is she now with reference to her starting position?

- (a) 35 metres West

- (b) 5 metres West
- (c) 35 metres East
- (d) 5 metres East

Directions (8-9): In these questions two statements are given, followed by two conclusions, I and II. You have to consider the statements to be true even if it seems to be at variance from commonly known facts. You have to decide which of the given conclusions, if any, follows from the given statements.

Q8. Statement I: No clocks are watches.

Statement II: No ornaments are clocks

Conclusion I: Some watches are ornaments

Conclusion II: All ornaments are watches

- (a) Only conclusion I follows
- (b) Only conclusion II follows
- (c) Both conclusions I and II follow
- (d) Neither conclusion I nor conclusion II follows

Q9. Statement I: All cakes are pastries

Statement II: Some bread are cakes

Conclusion I: No pastries are bread

Conclusion II: Some bread are pastries

- (a) Only conclusion I follows
- (b) Only conclusion II follows
- (c) Both conclusions I and II follow
- (d) Neither conclusion I nor conclusion II follows

Q10. In the following figure, rectangle represents Chefs, circle represents Choreographers, triangle represents Divers and square represents Americans. Which set of letters represents Americans who are either Choreographers or Divers?

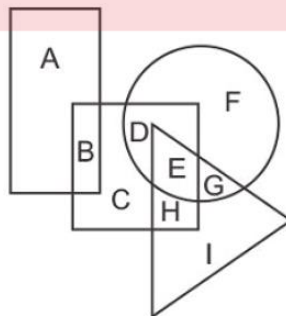

- (a) CDE
- (b) EGI
- (c) DEH
- (d) BCH

Q11. If a mirror is placed on the line MN, then which of the answer figures is the right image of the given figure?

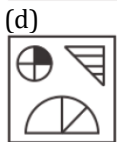
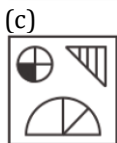
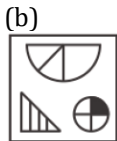
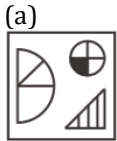
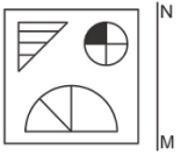

Q12. Hansh's birthday is on Monday 5th June. On what day of the week will be Tushar's Birthday in the same year if Tushar was born on 11th December?

- (a) Sunday
- (b) Wednesday
- (c) Monday
- (d) Tuesday

Q13. Which answer figure will complete the pattern in the question figure?

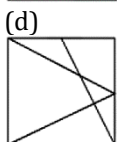
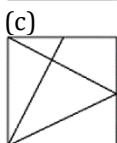
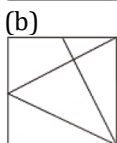
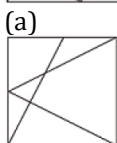
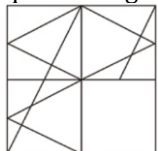

Q14. Select the missing number from the given responses.

| | | | |
|----|---|---|----|
| 10 | 4 | 2 | 12 |
| 7 | ? | 3 | 15 |
| 8 | 5 | 1 | 3 |

- (a) 9
- (b) 1
- (c) 25
- (d) 2

Q15. Which one of the following diagrams best depicts the relationship among teachers, graduates and women ?

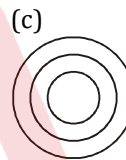
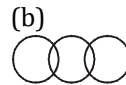

Q16. Find the minimum number of straight lines required to make the given figure.

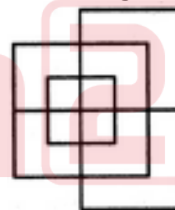

- (a) 13
- (b) 15
- (c) 17
- (d) 19

Q17. In each of following questions first questions figures are given, showing a sequence in which paper is folded and cut from a particular section below these figure a set of answer figures showing the paper actually acquires when it is unfolded are also given. Select your best answer.

Question Figures

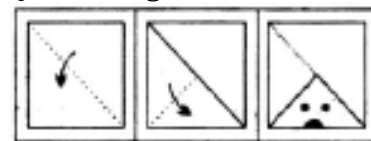

Answer Figures

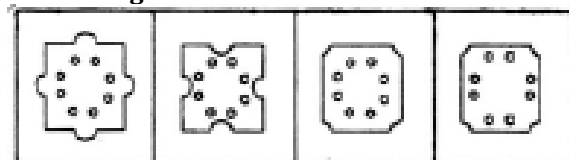

- (1)
 - (2)
 - (3)
 - (4)
- (a) 1

- (b) 2
(c) 3
(d) 4

Directions (18-20): Six friends are sitting in a circle facing the centre of the circle. Deepa is between Prakash and Pankaj. Priti is between Mukesh and Lalit. Prakash and Mukesh are opposite to each other.

Q18. Who is sitting right to Prakash?

- (a) Mukesh
(b) Deepa
(c) Pankaj
(d) Lalit

Q19. Who are the neighbours of Mukesh?

- (a) Prakash and Deepa
(b) Deepa and Preeti
(c) Priti and Pankaj
(d) Lalit and Priti

Q20. Who is sitting opposite to Priti?

- (a) Prakash
(b) Deepa
(c) Pankaj
(d) Lalit

Q21. In the following question, select the related word pair from the given alternatives.

Start : End :: ? : ?

- (a) Hot : Water
(b) Love : Care
(c) Green : Go
(d) Up : Down

Q22. In the following question, select the related number pair from the given alternatives.

31 : 42 :: ? : ?

- (a) 53 : 64
(b) 47 : 59
(c) 61 : 73
(d) 44 : 34

Q23. In the following question, select the related letter/letters from the given alternatives.

FUT : JYX :: BUG : ?

- (a) AYG
(b) FYK
(c) LCK
(d) FAM

Q24. In the following question, select the odd word from the given alternatives.

- (a) Ocean
(b) Sea
(c) Desert
(d) River

Q25. In the following question, select the odd letter/letters from the given alternatives.

- (a) KQW
(b) RXD
(c) BHN
(d) AGL

Q26. From the given alternatives, according to dictionary, which word will come at the LAST position?

1. Toast
 2. Torpedo
 3. Tounge
 4. Trickle
 5. Trick
- (a) Trick
(b) Trickle
(c) Tounge
(d) Torpedo

Q27. In the following question, select the missing number from the given series.

13, 17, 19, 23, 29, ?

- (a) 33
(b) 31
(c) 35
(d) 37

Q28. A series is given with one term missing. Select the correct alternative from the given ones that will complete the series.

UY, SV, QS, OP, ?

- (a) NM
(b) ML
(c) MM
(d) KL

Q29. L, M, N, O and P are sitting in a line facing east. L and M are sitting together. N is sitting at north end and O is sitting at south end. P is the neighbour of M and N. Who is third from north end?

- (a) L
(b) O
(c) M
(d) P

Q30. From the given alternatives, select the word which CANNOT be formed using the letters of the given word.

Corporate

- (a) Poor
(b) Rate
(c) Cat
(d) Prove

Q31. In a certain code language, "PRICE" is written as "GEKTR". How is "VALUE" written in that code language?

- (a) FWNCX
- (b) FNWDY
- (c) DWNCY
- (d) GWNCX

Q32. In a certain code language, '-' represents '+', '+' represents 'x', 'x' represents '÷' and '÷' represents '-'. Find out the answer to the following question.

$$9 - 18 + 35 \times 10 \div 30 = ?$$

- (a) 44
- (b) 42
- (c) 40
- (d) 41

Q33. The following equation is incorrect. Which two signs should be interchanged to correct the equation?

$$20 \div 14 + 5 \times 20 - 2 = 56$$

- (a) + and x
- (b) ÷ and -
- (c) + and ÷
- (d) - and +

Q34. If $16\alpha 1 = 8$, $14\alpha 6 = 42$ and $12\alpha 5 = 30$, then find the value of $2\alpha 6 = ?$

- (a) 6
- (b) 18
- (c) 4
- (d) 10

Q35. An insect walks 15 cm East, then it turns to its right and walks for another 20 cm. then it turns right and walks 4 cm, then it turns North and walks 20 cm, then finally it turns to its left and walks 2 cm. Where is the insect now with respect to its starting point?

- (a) 9 cm East
- (b) 21 cm East
- (c) 9 cm West
- (d) 21 cm West

Q36. In the following figure, rectangle represents journalists, circle represents Art critics, triangle represents Campers and square represents Mothers Which set of letters represents Mothers who are Campers ?

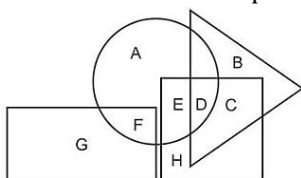

- (a) DC
- (b) BDCH
- (c) EDC
- (d) HEB

Q37. If a mirror is placed on the line MN, then which of the answer figures is the right image of the given figure ?

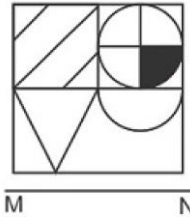

(a)



(b)



(c)



(d)



Directions (38-39) : In the question two statements are given, followed by two conclusions, I and II. You have to consider the statements to be true even if it seems to be at variance from commonly known facts. You have to decide which of the given conclusions, if any, follows from the given statements.

Q38. Statement I: Some games are sports

Statement II: No exercise are games

Conclusion I: All sports are exercise

Conclusion II: Some exercise are sports

- (a) Only conclusion I follows
- (b) Only conclusion II follows
- (c) Both conclusions I and II follow
- (d) Neither conclusion I nor conclusion II follows

Q39. Statement I: Some notes are coins

Statement II: All notes are currency

Conclusion I: No coins are currency

Conclusion II: Some currency are coins

- (a) Only conclusion I follows
- (b) Only conclusion II follows
- (c) Both conclusions I and II follow
- (d) Neither conclusion I nor conclusion II follows

Q40. Which will replace the question mark?

| | | | |
|---|----|---|----|
| 3 | 11 | 4 | 56 |
| 2 | 4 | 6 | 36 |
| 3 | 7 | 8 | ? |

- (a) 72
(b) 80
(c) 76
(d) 84

Q41. Select the related word/letters/number from the given alternatives.

Pernicious : Lethal :: Indict : ?

- (a) Insolent
(b) Impudent
(c) Spoil
(d) Accuse

Q42. Select the related word/letters/number from the given alternatives.

4 : 44 :: ? : 77

- (a) 3
(b) 6
(c) 7
(d) 5

Q43. Select the related word/letters/number from the given alternatives.

Ctrl+X : Cut :: Ctrl+C : ?

- (a) Undo
(b) Paste
(c) Redo
(d) Copy

Q44. Six persons A, B, C, D, E and F are standing in a circle. B is between F and C. A is between E and D. F is to the left of D. Who is between B and D?

- (a) E
(b) C
(c) F
(d) A

Q45. A series is given with one term missing. Choose the correct alternative from the given ones that will complete the series.

Rajasthan, Madhya Pradesh, Maharashtra, ?

- (a) Uttar Pradesh
(b) Jammu Kashmir
(c) Tamil Nadu
(d) Assam

Q46. A series is given with one term missing. Choose the correct alternative from the given ones that will complete the series.

200, 100, 50, 25, 12.5, 6.25, ?

- (a) 2.125
(b) 3.025
(c) 3.125
(d) 2.025

Q47. Arrange the given words in the sequence in which they occur in the dictionary.

- i. Translucent
ii. Transparent
iii. Transport
iv. Transistor

- (a) iv, i, ii, iii
(b) iv, i, iii, ii
(c) i, iii, ii, iv
(d) i, ii, iii, iv

Q48. In a certain code language, "INSTANT" is written as "IOUWESZ". How is "FORGET" written in that code language?

- (a) FPOGXI
(b) FOSIGX
(c) FPSKHW
(d) FPTJIY

Q49. Which set of letters when sequentially placed at the gaps in the given letter series shall complete it?

l_n_o_m_lm_o

- (a) mnoln
(b) mlnmn
(c) monln
(d) mnmno

Q50. A boy travels 4 km towards south and then takes a right turn travels another 3 km in that direction. How far and in which direction is he now from his original position?

- (a) 6 km, south
(b) 5 km, southwest
(c) 4 km, north
(d) 5 km, northwest

Q51. In the following question, select the related word pair from the given alternatives.

Thursday : Friday :: ? : ?

- (a) Monday : Tuesday
(b) Friday : Sunday
(c) Friday : Wednesday
(d) Sunday : Tuesday

Q52. In the following question, select the related number from the given alternatives.

594 : 592 :: 368 : ?

- (a) 370
(b) 340
(c) 364
(d) 366

Q53. In the following question, select the related letter/letters from the given alternatives.

KPV : LQW :: BOY : ?

- (a) APX
(b) CPZ
(c) CPX
(d) DQZ

Q54. In the following question, select the odd word from the given alternatives.

- (a) Cauliflower
- (b) Potato
- (c) Grapes
- (d) Brinjal

Q55. In the following question, select the odd letter/letters from the given alternatives.

- (a) GJMP
- (b) HKNR
- (c) PSVY
- (d) NQTW

Q56. Arrange the given words in the sequence in which they occur in the dictionary.

- 1. Telephone
 - 2. Teleworker
 - 3. Tendency
 - 4. Temperature
 - 5. Themselves
- (a) 34521
 - (b) 42153
 - (c) 52314
 - (d) 12435

Q57. In the following question, select the missing number from the given series.

4, 5, 8, 9, 12, 13, ?

- (a) 14
- (b) 16
- (c) 15
- (d) 20

Q58. A series is given with one term missing. Select the correct alternative from the given ones that will complete the series.

EGL, DFK, CEJ, ?, ACH

- (a) BFJ
- (b) CFD
- (c) HDI
- (d) BDI

Q59. Weight of Alok is twice the weight of Karan. Weight of Karan is one-fourth of the weight of Roma. Weight of Roma is twice of the weight of Tipu. Weight of Tipu is twice of the weight of Shivam. The weight of Roma is greater than the weight of how many persons among Alok, Karan, Shivam and Tipu?

- (a) 3
- (b) 4
- (c) 0
- (d) 2

Q60. From the given alternatives, select the word which CANNOT be formed using the letters of the given word.

- Compatible
- (a) Come
 - (b) Pat
 - (c) Time
 - (d) Most

Q61. Find the related word as expressed in given pair.
Tiger : Flesh :: Cow : ?

- (a) Snake
- (b) Grass
- (c) Worm
- (d) Animal

Q62. Find the related letter(s) as expressed in given pair.
QSMO : YAUW :: KMGI : ?

- (a) SUQO
- (b) USOQ
- (c) UQSO
- (d) SUOQ

Q63. Find the related number as expressed in given pair.
7 : 28 :: 4 : ?

- (a) 23
- (b) 26
- (c) 16
- (d) 20

Q64. Select the odd word from the given alternatives.

- (a) Gold
- (b) Iron
- (c) Steel
- (d) Nitrogen

Q65. Select the odd letters from the given alternatives.

- (a) KN
- (b) GI
- (c) DF
- (d) LN

Q66. Select the odd number from the given alternatives.

- (a) 64
- (b) 48
- (c) 42
- (d) 60

Q67. In a certain code language "CAGES" is written as "MZCXA". How is "WATER" written in that code language?

- (a) LZPXU
- (b) SGWEB
- (c) QCPVR
- (d) VYQAM

Q68. If $81 \# 49 = 2$ and $100 \# 36 = 4$ then $144 \# 196 = ?$

- (a) 26
- (b) -26
- (c) 2
- (d) -2

Q69. In the following question, select the word which cannot be formed using the letters of the given word.

QUALIFICATION

- (a) LIAR
- (b) FIAT
- (c) LION
- (d) FICTION

Q70. Which symbol lie opposite to the face having symbol '%', when the figure is folded to form a cube?

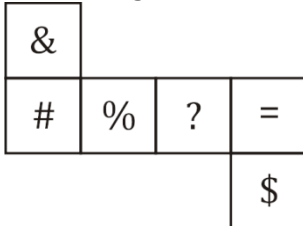

- (a) #
- (b) \$
- (c) &
- (d) =

Q71. In a certain code language, "WARD" is written as "44" and "LOAD" is written as "30". How is "BRIT" written in that code language?

- (a) 49
- (b) 47
- (c) 48
- (d) 50

Q72. In a certain code language, '-' represents 'x', '÷' represents '+', '+' represents '÷' and 'x' represents '-'. Find out the answer to the following question.

$$12 - 2 + 6 \times 20 \div 18 = ?$$

- (a) 50
- (b) 2
- (c) 19
- (d) 43

Q73. The following equation is incorrect. Which two signs should be interchanged to correct the equation?

$$18 \div 2 - 25 \times 9 + 6 = 38$$

- (a) + and x
- (b) + and ÷
- (c) - and +
- (d) ÷ and x

Q74. If $18\alpha 12 = 3$, $2\alpha 14 = -6$ and $4\alpha 4 = 0$, then find the value of $2\alpha 16 = ?$

- (a) -7
- (b) 8
- (c) 10
- (d) -1

Q75. A woman is shopping in a plaza. She walks 80 m South, then she turns East and walks 50 m, then she turns North and walks 110 m, then she turns to her left and walks 50 m. Where is she now with reference to her starting position?

- (a) 30 m North
- (b) 190 m North
- (c) 30 m South
- (d) 190 m South

Directions (76-77): In the question two statements are given, followed by two conclusions, I and II. You have to consider the statements to be true even if it seems to be at variance from commonly known facts. You have to decide which of the given conclusions, if any, follows from the given statements.

Q76. Statement :

- (I) Some flipflops are slippers
- (II) Some footwear are flipflops

Conclusion :

- (I) All slippers are footwear
- (II) All footwear are slippers
- (a) Only conclusion I follows
- (b) Only conclusion II follows
- (c) Both conclusions I and II follow
- (d) Neither conclusion I nor conclusion II follows

Q77. Statements:

- (I) Some bags are hot.
- (II) All hot things are cakes.

Conclusion:

- (I) All cakes are bags.
- (II) All bags are cakes.
- (a) Only conclusion I follows
- (b) Only conclusion II follows
- (c) Neither I nor II follows
- (d) Both I and II follows

Q78. In the following figure, rectangle represents Technicians, circle represents Bakers, triangle represents Playwright and square represents Gymnasts. Which set of letters represents Technicians who are Bakers?

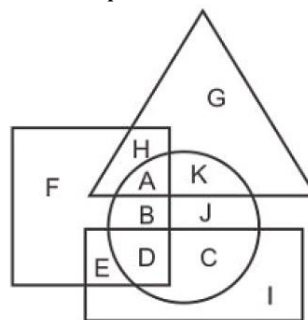

- (a) BJ
- (b) DC
- (c) AK
- (d) BD

Q79. In the following question, select the missing number from the given series.

| | | |
|----|---|----|
| 81 | 3 | 90 |
| 60 | 4 | 76 |
| 49 | 6 | ? |

- (a) 78
- (b) 80
- (c) 85
- (d) 75

Q80. Rahul is the father of Anupreet's husband. Priya and Ankit are the only two children of Rahul. Priya is the sister-in-law of Anupreet. How is Ankit related to Anupreet?

- (a) Father
- (b) Grandson
- (c) Son
- (d) Husband

Q81. How many triangles are there in the given figure?

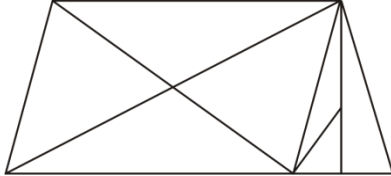

- (a) 15
- (b) 14
- (c) 16
- (d) 13

Q82. Pointing towards a boy, a lady said, that boy is the brother of my husband is only daughter's daughter. "How is that lady's son related to that boy?"

- (a) Father
- (b) Uncle
- (c) Brother
- (d) Son

Directions (83-85): 6 boys P, Q, R, S, T and U are standing in a row facing north. P and Q cannot be either at 1st or 2nd place. R and S will always be together and R must be at one of the ends. R doesn't have S to his right. U is standing between T and P.

Q83. Who is standing on west end?

- (a) T
- (b) P
- (c) U
- (d) S

Q84. Who is standing right to P?

- (a) U
- (b) Q
- (c) R
- (d) S

Q85. If one more person V comes to stand at the left of P, then who is standing in middle?

- (a) V
- (b) T
- (c) S
- (d) P

Q86. Which of the following venn diagram best represents the relationship between Football, Player and Field.

- (a)
- (b)
- (c)
- (d)

Q87. Select a suitable figure from the answer figures that would replace the question mark (?)



- (A) (B) (C) (D)
- (1) (2) (3) (4)
- (a) 1
- (b) 2
- (c) 3
- (d) 4

Q88. which will replace the question mark?

| | | |
|----|----|----|
| 7 | 4 | 10 |
| 6 | 2 | 2 |
| 3 | 4 | 2 |
| 15 | 14 | ? |

- (a) 21
- (b) 25
- (c) 18
- (d) 14

Q89. Ratio of present ages of Mohan and Sohan is 4 : 6 and the difference between their ages is 12 years. What is the present age (in yrs) of Sohan?

- (a) 24
- (b) 28
- (c) 36
- (d) 42

Q90. In each of following questions first questions figures are given, showing a sequence in which paper is folded and cut from a particular section below these figure a set of answer figures showing the paper actually acquires when it is unfolded are also given. Select your best answer.

Question Figures

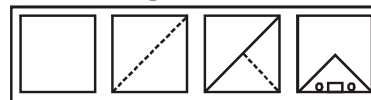

Answer Figures

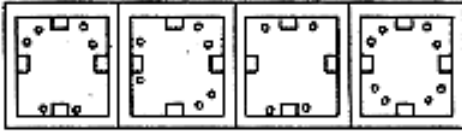

- (1) (2) (3) (4)
(a) 1
(b) 2
(c) 3
(d) 4

Q91. If a mirror is placed on the line MN, then which of the answer figures is the right image of the given figure?

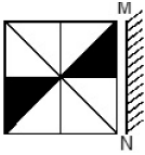

- (a)
- (b)
- (b)
- (b)
- (d)

Q92. How many triangles are there in the given figure?

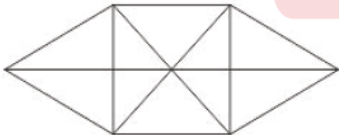

- (a) 16
(b) 20
(c) 22
(d) 24

Q93. Identify the diagram that best represents the relationship among the given classes.

Bull, Animal, Carnivorous

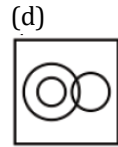
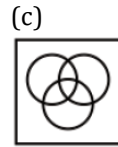
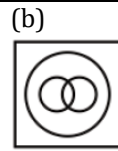
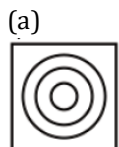

Q94. A piece of paper is folded and punched as shown below in the question figures. From the given answer figures, indicate how it will appear when opened.

Question Figures



Answer Figures

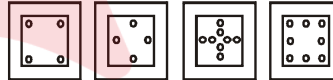

- (1) (2) (3) (4)
(a) 1
(b) 2
(c) 3
(d) 4

Q95. Select a figure from the given four options, which when placed in the blank space of problem figure(?) would complete the pattern.



Answer Figures.



- (1) (2) (3) (4)
(a) 1
(b) 2
(c) 3
(d) 4

Q96. Form the given answer figures select the one in which the question figure is hidden / embedded.

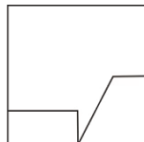

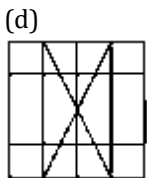
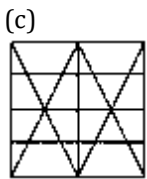
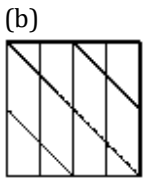
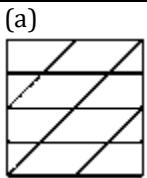

Q97. The following equations follow a common property Find out the correct value to complete D :

- A = 51 (714) 14;
- B = 61 (915) 15;
- C = 71 (1136) 16;
- D = 81 (?) 17

- (a) (1377)
- (b) (1378)
- (c) (1356)
- (d) (1346)

Q98. Kishankant walks 10 km towards North. From there, he walks 6km towards South. Then he walks 3km towards East. How far and in which direction is he with reference to his starting point?

- (a) 5km West
- (b) 5km North-East
- (c) 7km East
- (d) 7km West

Q99. A is mother of D and sister of B. B has a daughter C, who is married to F. G is the husband of A. How is G related to D ?

- (a) Husband
- (b) Son
- (c) Father
- (d) Uncle

Q100. Select the odd word from the given alternatives.

- (a) Wheat
- (b) Rice
- (c) Jowar
- (d) Beans

Q101. Find the missing number from the given series?

- 10, 12, 22, 34, ?, 90
- (a) 56
 - (b) 46
 - (c) 60
 - (d) 76

Q102. Find the missing number from the given series?

- 3, 7, 19, 55, 163, ?
- (a) 487
 - (b) 310
 - (c) 467
 - (d) 285

Q103. Which will replace the question mark?

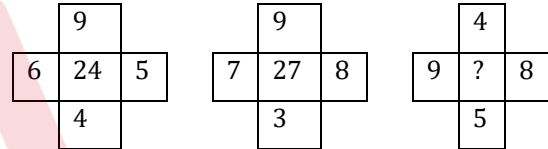

- (a) 20
- (b) 16
- (c) 26
- (d) 24

Q104. Which will replace the question mark?

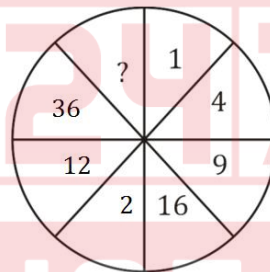

- (a) 85
- (b) 90
- (c) 95
- (d) 80

Q105. In the given figure, how many large bottles are not blue?

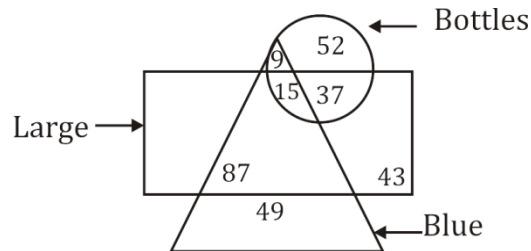

- (a) 37
- (b) 15
- (c) 152
- (d) 89

Directions (106-107) In following question some statements followed by some conclusions are given. Taking the given statements to be true even if they seem to be at variance from commonly known facts, read all the conclusions and then decide which of the given conclusion logically follows the given statements.

Q106. Statements :

- I. All girls are mad
- II. Some boys are mad

Conclusions :

- I. Some mad are girls
- II. All boys are girls
- (a) Only conclusion I follows
- (b) Only conclusion II follows
- (c) Both I and II follow
- (d) Neither of them follows

Q107. Statements :

- I. All cups are books
- II. All books are shirts

Conclusions :

- I. Some cups are not shirts
- II. Some shirts are cups
- (a) Only conclusion I follows
- (b) Only conclusion II follows
- (c) Both I and II follow
- (d) Neither of them follows

Q108. How many triangles are there in the given figure?

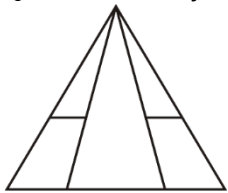

- (a) 8
- (b) 7
- (c) 9
- (d) 6

Q109. A and B are brothers, C and D are sisters. A's son is D's brother. How is B related to C?

- (a) Father
- (b) Brother
- (c) Grandfather
- (d) Uncle

Q110. Shakti runs 20m towards East and turns to right runs 10m and again turns to right, runs 9 m and turns to left, runs 5 m and then again turns left, runs 12m and finally turns left and runs 6m. In which direction is he facing now?

- (a) East
- (b) West
- (c) North
- (d) South

Q111. The ratio of present ages of A and B is 3 : 4. After four years their ages will be in ratio 11 : 13. What is present age (in years) of B ?

- (a) 6.4
- (b) 4.8
- (c) 10.1
- (d) 14

Q112. In a row of people Mayank is 8th from bottom. Pramod is 12 ranks above Mayank. If Pramod is 9th from top, then how many people are there in this row?

- (a) 25
- (b) 26
- (c) 28
- (d) 23

Directions (113-115): P, Q, R, S, T, U and V are sitting on a row, facing north. U is immediate right of T. T is 4th to the right of V. R is the neighbor of Q and S. Person who is third to the left of S is at one of ends.

Q113. Who is/are sitting to the left of R ?

- (a) Only Q
- (b) V, Q and S
- (c) V and Q
- (d) S, T, U and P

Q114. Who are the neighbours of Q ?

- (a) R and S
- (b) R and V
- (c) V and U
- (d) R and T

Q115. What is position of P?

- (a) Between T and S
- (b) Extreme left
- (c) Extreme right
- (d) Centre

Q116. Which of the following Venn diagram best represent the relationship between clerks, government employee, educated persons?

- (a)
- (b)
- (c)
- (d)

Q117. In a certain code language, '-' represents 'x', '÷' represents '+', '+' represents '÷' and 'x' represents '-'. Find out the answer to the following question.

$$12 - 6 + 4 \times 10 \div 16 = ?$$

- (a) 20
- (b) 26
- (c) 24
- (d) 18

Q118. If alphabet series is given in backward or reverse order, then find out the eighth letter to right of O ?

- (a) H
- (b) G
- (c) U
- (d) X

Q119. Which answer figure will complete the pattern in the question figure?



- (a)
- (b)
- (c)
- (d)

Q120. If a mirror is placed on the line AB, then which of the answer figure is the right image of the given figure?

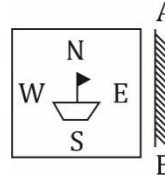

- (a)
- (b)
- (c)
- (d)

Q121. In the following question, select the related word pair from the given alternatives.

Truth : Lie :: ? : ?

- (a) Big : Small
- (b) Pink : Colour
- (c) Big : Huge
- (d) Lawyer : Black

Q122. In the following question, select the related number from the given alternatives.

5 : 25 :: 6 : ?

- (a) 39
- (b) 37
- (c) 28
- (d) 36

Q123. In the following question, select the related letter pair from the given alternatives.

FMR : ELQ :: ? : ?

- (a) PEN : QFO
- (b) ZEN : XCL
- (c) TGA : SFZ
- (d) SMP : UOR

Q124. In the following question, select the odd word pair from the given alternatives.

- (a) Up - Down
- (b) Big - Small
- (c) Run - Fast
- (d) Lie - Truth

New Launch Hinglish

DEFENCE

Test Mate

AFCAT | CDS I
CAPF ACs & Other

2000+ Total Tests

Q125. In the following question, four number pairs are given. The number on left side of (-) is related to the number of the right side of (-) with some Logic / Rule / Relation. Three are similar on basis of same Logic/Rule/Relation. Select the odd one out from the given alternatives.

- (a) 11 - 144
- (b) 13 - 196
- (c) 15 - 246
- (d) 17 - 324

Q126. In the following question, select the odd letter/letters from the given alternatives.

- (a) HS
- (b) KP
- (c) GR
- (d) BY

Q127. Arrange the given words in the sequence in which they occur in the dictionary.

1. Read
2. Real
3. Ready
4. Rather
5. Ratify

- (a) 32415
- (b) 12543
- (c) 45123
- (d) 45132

Q128. In the following question, select the missing number from the given series.

- 9, 13, 22, 38, 63, ?
- (a) 96
 - (b) 99
 - (c) 84
 - (d) 90

Q129. A series is given with one term missing. Select the correct alternative from the given ones that will complete the series.

PCK, RFM, TJO, VOQ, ?

- (a) XVT
- (b) YVT
- (c) XUS
- (d) ZUS

Q130. In a row of girls, Shweta is 11th from the right end. Mansi is 14th to the left of Shweta. If Mansi is 12th from the left end, then how many girls are there in the row?

- (a) 40
- (b) 38
- (c) 37
- (d) 36

Solutions

S1. Ans.(b)

Sol. Action

S2. Ans.(d)

Sol.

| | | | | | | | | |
|---|---|---|---|---|---|---|---|---|
| T | R | U | M | P | G | A | I | N |
| 4 | 6 | 3 | 2 | 1 | 7 | 5 | 9 | 8 |

GRUNT → 7 6 3 8 4

S3. Ans.(d)

Sol. $2 \times 12 \div 32 - 5 + 4$

ATQ,

$$\Rightarrow 2 - 12 \div 32 \times 5 \div 4$$

$$\Rightarrow 2 - 12 + 40$$

$$\Rightarrow 42 - 12$$

$$\Rightarrow 30$$

S4. Ans.(c)

Sol. $14 + 8 \div 16 - 9 \times 12 = 10$

After interchanging + and x

$$\Rightarrow 14 \times 8 \div 16 - 9 + 12 = 10$$

$$\Rightarrow 7 - 9 + 12 = 10$$

$$\Rightarrow 19 - 9 = 10$$

$$\Rightarrow 10 = 10$$

S5. Ans.(c)

Sol. $-3 \times 1 = -3 \times (-1) = 3$

$$3 \times 6 = 18 \times (-1) = -18$$

$$-7 \times 4 = -28 \times (-1) = 28$$

$$-2 \times 9 = -18 \times (-1) = 18$$

S6. Ans.(b)

Sol. CCABABAB

S7. Ans.(a)

Sol.

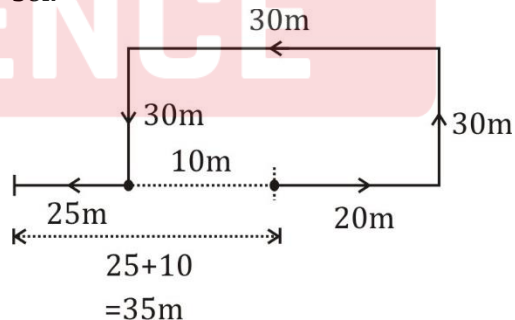

She is now 35m in west direction from her starting point.

S8. Ans.(d)

Sol.

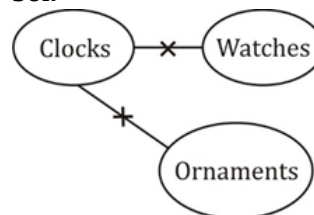

I. × II. ×

Neither conclusion I nor conclusion II follows.

S9. Ans.(b)

Sol.

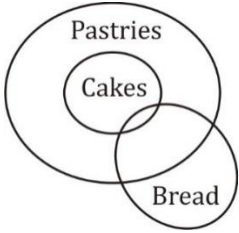

I. ×

II. ✓

Only conclusion II follows

S10. Ans.(c)

Sol. DEH

S11. Ans.(d)

S12. Ans.(c)

Sol. 5th June = Monday

Number of days till 11 Dec = 25 + 31 + 31 + 30 + 31 + 30 + 11
= 189

∴ No. of odd days = $\frac{189}{7} = 0$ odd days

∴ Day on 11 December = Monday + 0
= Monday

S13. Ans.(c)

S14. Ans.(d)

Sol. $(10 \times 2) - (4 \times 2) = 12$

$(8 \times 1) - (5 \times 1) = 3$

$(7 \times 3) - (2 \times 3) = 15$

S15. Ans.(d)

Sol.

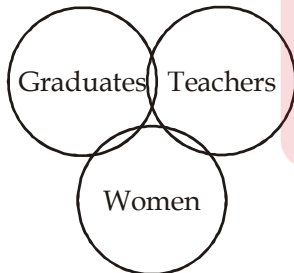

Here, some teachers may be women and some women may be graduates. Also some graduates may be teachers.

S16. Ans.(a)

Sol. The figure may be labeled as shown.

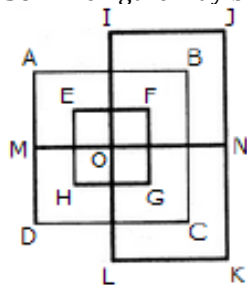

The horizontal lines are IJ, AB, EF, MN, HG, DC and LK i.e. 7 in number.

The vertical lines are AD, EH, IL, FG, BC and JK i.e. 6 in number. Thus, there are 7 + 6 = 13 straight lines in the figure.

S17. Ans.(b)

Sol.

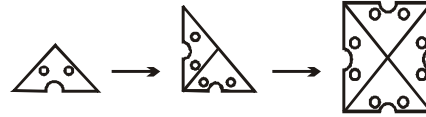

Solutions (98-100)

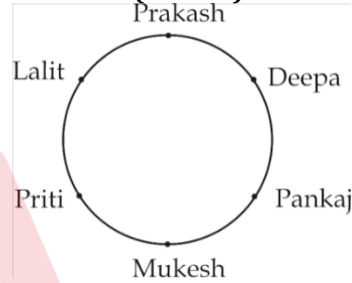

S18. Ans.(d)

S19. Ans.(c)

S20. Ans.(b)

S21. Ans.(d)

Sol.

Start ↔ End } Opposite
Up ↔ Down }

S22. Ans.(a)

Sol. +11 series

S23. Ans.(b)

Sol. +4 series

S24. Ans.(c)

Sol. Except Desert, rest are water bodies

S25. Ans.(d)

Sol. +6 series except (AGL)

S26. Ans.(b)

Sol. Trickle

S27. Ans.(b)

Sol. Sequence of prime numbers

S28. Ans.(c)

Sol. -2, -3 series

S29. Ans.(c)

Sol.

N

P

(M) → 3rd from North end.

L

O

S30. Ans.(d)

Sol. Prove

S31. Ans.(d)

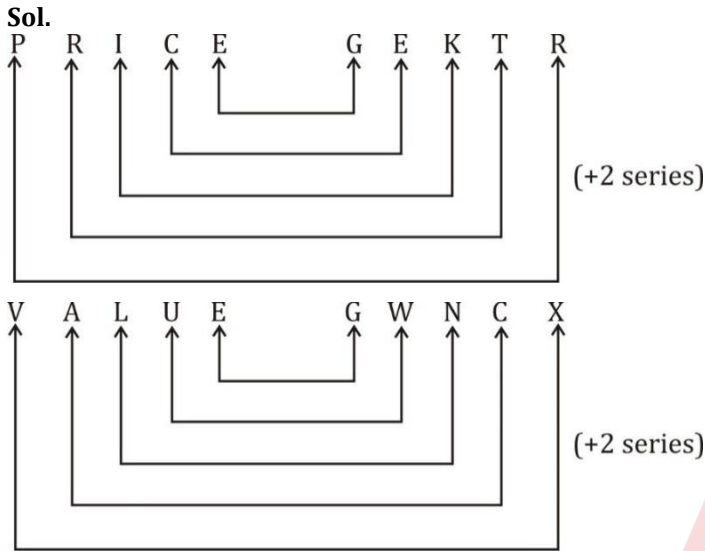

S32. Ans.(b)

Sol. $9 - 18 + 35 \times 10 \div 30$
 $\Rightarrow 9 + 18 \times 35 \div 10 - 30$
 $\Rightarrow 9 + 18 \times 3.5 - 30$
 $\Rightarrow 9 + 63 - 30$
 $\Rightarrow 72 - 30$
 $\Rightarrow 42$

S33. Ans.(b)

Sol. $20 \div 14 + 5 \times 20 - 2 = 56$
 $\Rightarrow 20 - 14 + 5 \times 20 \div 2 = 56$
 $\Rightarrow 20 - 14 + 5 \times 10 = 56$
 $\Rightarrow 20 - 14 + 50 = 56$
 $\Rightarrow 70 - 14 = 56$
 $\Rightarrow 56 = 56$

S34. Ans.(a)

Sol. $\frac{16}{2} \times 1 = 8$
 $\frac{14}{2} \times 6 = 42$
 $\frac{12}{2} \times 5 = 30$
 $\frac{2}{2} \times 6 = 6$

S35. Ans.(a)

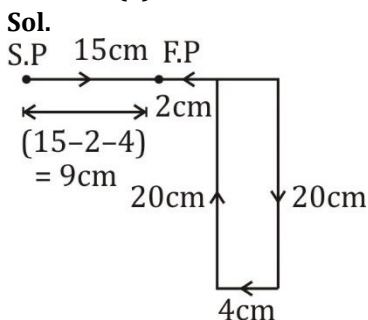

Insect is at 9 cm in East from the starting point.

S36. Ans.(a)

Sol. DC

S37. Ans.(b)

S38. Ans.(d)

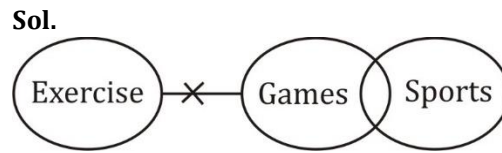

I. \times II. \times
 Neither conclusion I nor conclusion II follows.

S39. Ans.(b)

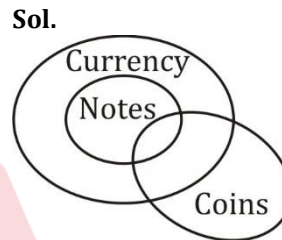

Only conclusion II follows

S40. Ans.(b)

Sol. $(3 + 11) \times 4 = 56$
 $(2 + 4) \times 6 = 36$
 Similarly,
 $(7 + 3) \times 8 = 80$

S41. Ans.(d)

Sol. Accuse, Synonyms are given

S42. Ans.(c)

Sol. $4 \times 11 = 44$
 $7 \times 11 = 77$

S43. Ans.(d)

Sol. Ctrl + X is a shortcut command for cut
 Ctrl + C is a shortcut command for copy

S44. Ans.(c)

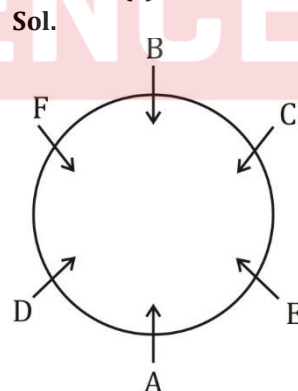

\therefore F is in between B and D.

S45. Ans.(a)

Sol. According to area
 Rajasthan > Madhya Pradesh > Maharashtra > Uttar Pradesh

S46. Ans.(c)

Sol. $\div 2$ series

S47. Ans.(a)

Sol. IV. Transistor

- I. Translucent
- II. Transparent
- III. Transport

S48. Ans.(d)

Sol.

| | | | | | | | | | | | | |
|-----|-----|-----|-----|-----|-----|-----|-----|-----|-----|-----|-----|-----|
| I | N | S | T | A | N | T | F | O | R | G | E | T |
| +0↓ | +1↓ | +2↓ | +3↓ | +4↓ | +5↓ | +6↓ | +0↓ | +1↓ | +2↓ | +3↓ | +4↓ | +5↓ |
| I | O | U | W | E | S | Z | F | P | T | J | I | Y |

S49. Ans.(c)

Sol. $l \underline{m} n \underline{o} / o \underline{n} m \underline{l} / l m \underline{n} o$

S50. Ans.(b)

Sol.

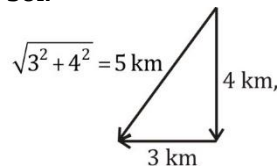

∴ 5 km, south west

S51. Ans.(a)

Sol. Friday comes after Thursday
Similarly, Tuesday comes after Monday

S52. Ans.(d)

Sol.

| | | | | | | |
|-----------|---|-----|----|-----------|---|-----|
| 594 | : | 592 | :: | 368 | : | 366 |
| └───┬───┘ | | | | └───┬───┘ | | |
| | | -2 | | | | -2 |

S53. Ans.(b)

Sol. +1 pattern

S54. Ans.(c)

Sol. Except grapes, all are vegetables

S55. Ans.(b)

Sol. Except in option (b), +3 pattern follows in other options.

S56. Ans.(d)

Sol. Correct order is 12435.

S57. Ans.(b)

Sol.

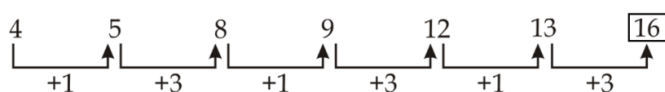

S58. Ans.(d)

Sol. - 1 series

S59. Ans.(b)

Sol. Let weight of Shivam = x

Weight of Tipu = 2x

Weight of Roma = 4x

Weight of Karan = x

Weight of Alok = 2x

S60. Ans.(d)

Sol. Most, there is no 's' in Compatible.

S61. Ans.(b)

Sol. Tiger eats flesh. Similarly, Cow eats grass.

S62. Ans.(d)

Sol. (+ 8 series)

S63. Ans.(c)

Sol. $7 \times 4 = 28$. Similarly, $4 \times 4 = 16$

S64. Ans.(d)

Sol. All others are solid whereas Nitrogen is a gas.

S65. Ans.(a)

Sol. Except KN, in all other options (+2 patterns) follows.

S66. Ans.(a)

Sol. All others are not cubes of an integer but 64 is a perfect cube.

S67. Ans.(a)

Sol.

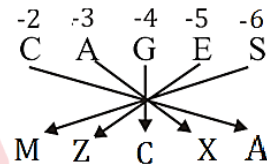

Similarly,

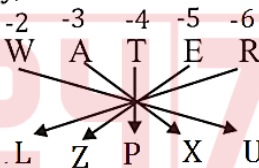

S68. Ans.(d)

Sol. $\sqrt{81} - \sqrt{49} = 2$

$\sqrt{100} - \sqrt{36} = 4$

Similarly,

$\sqrt{144} - \sqrt{196} = -2$

S69. Ans.(a)

Sol. There is no 'R' in QUALIFICATION

S70. Ans.(d)

Sol. Opposite faces are :-

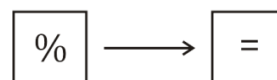
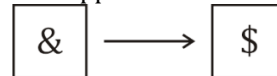

S71. Ans.(b)

Sol. WARD = $23 + 1 + 18 + 4 = 46 - 2 = 44$

LOAD = $12 + 15 + 1 + 4 = 32 - 2 = 30$

∴ BRIT = $2 + 18 + 9 + 20 = 49 - 2 = 47$

S72. Ans.(b)

Sol. $12 - 2 + 6 \times 20 \div 18$

Now, A/C to qus.

$= 12 \times 2 \div 6 - 20 + 18$

$= 4 - 20 + 18 = 2$

S73. Ans.(a)

Sol. $18 \div 2 - 25 \times 9 + 6 = 38$

Interchanging, + and \times

$18 \div 2 - 25 + 9 \times 6 = 38$

$= 9 - 25 + 9 \times 6 = 38$

$= 38 = 38$

S74. Ans.(a)

Sol. $18 \alpha 12 = 3$

$\{18 - 12 = \frac{6}{2} = 3\}$

$2 \alpha 14 = -6$

$\{2 - 14 = -\frac{12}{2} = -6\}$

$4 \alpha 4 = 0$

$\{4 - 4 = \frac{0}{2} = 0\}$

$2 \alpha 6 =$

$\{2 - 16 = \frac{-14}{2} = -7\}$

S75. Ans.(a)

Sol. She is 30 m away from starting position in north direction.

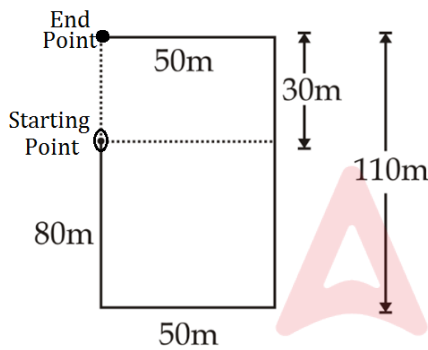

S76. Ans.(d)

Sol.

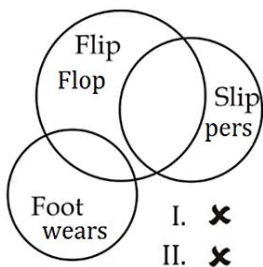

Neither conclusion I nor conclusions II follows.

S77. Ans.(c)

Sol.

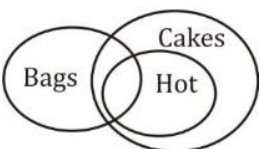

I. X

II. X

Neither I nor II follows

S78. Ans.(b)

Sol. DC

S79. Ans.(c)

$90 - 81 = 9 = 3^2$

$76 - 60 = 16 = 4^2$

$85 - 49 = 36 = 6^2$

S80. Ans.(d)

Sol.

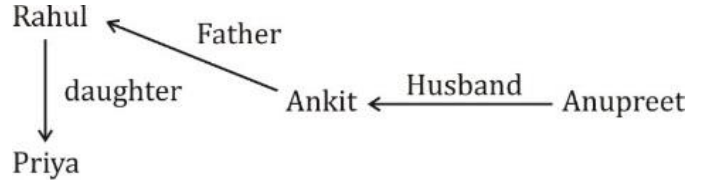

S81. Ans.(a)

Sol. 15 triangles

S82. Ans.(b)

Sol. Her husband's only daughter's daughter means her own daughter's daughter (Grand-daughter) and that lady's son is brother of her daughter. So that lady's son is uncle of the Grand-daughter or Grandson.

S83. Ans.(a)

Sol.

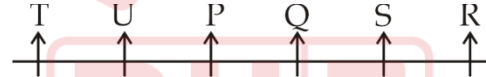

S84. Ans.(b)

Sol.

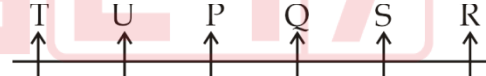

S85. Ans.(d)

Sol.

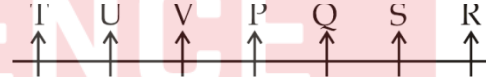

S86. Ans.(c)

Sol. Football, Players and Field all are different.

S87. Ans.(a)

Sol. The figure gets divided into eight parts.

S88. Ans.(c)

Sol. $(7 \times 3) - 6 = 15$

$(4 \times 4) - 2 = 14$

Similarly,

$(10 \times 2) - 2 = 18$

S89. Ans.(c)

Sol. Let age of Mohan and Sohan be $4x$ and $6x$

ATQ,

$6x - 4x = 12$

$\Rightarrow x = 6$

So, present age of Sohan = $6 \times 6 = 36$ yrs

S90. Ans.(d)

Sol.



S91. Ans.(a)

S92. Ans.(c)

Sol. There are 22 triangle formed.

S93. Ans.(d)

Sol.

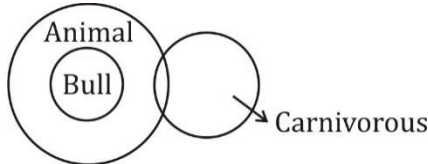

S94. Ans.(c)

Sol.



S95. Ans.(b)

Sol. Clearly option(b) will complete the figure.

S96. Ans.(c)

S997. Ans.(a);

Sol. A = 51 × 14 = 714

B = 61 × 15 = 915

C = 71 × 16 = 1136

D = 81 × 17 = 1377

S98. Ans.(b);

Sol. The movements of Kishankant are as shown in Fig. (A to B, B to C and C to D).

AC = (AB-BC) = (10-6) km = 4 km

Kishankant's distance from starting point A

$$= AD = \sqrt{AC^2 + CD^2} = \sqrt{4^2 + 3^2} = \sqrt{25} = 5 \text{ km}$$

So Kishankant is 5 km to the North-east of his starting point.

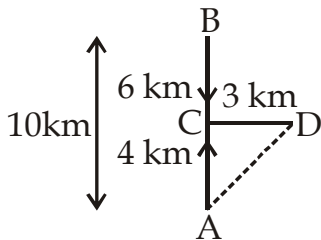

S99. Ans.(c)

Sol.

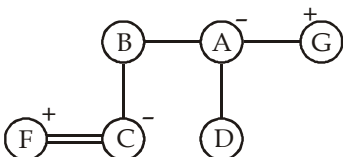

From the diagram it is clear that G is Father of D.

S100. Ans.(d)

Sol. Except Beans, all others are grains (cereals and coarse cereals)

S101. Ans.(a)

Sol. Each term in the series is the sum of the preceding two terms.

Missing number = 22 + 34 = 56

S102. Ans.(a)

Sol.

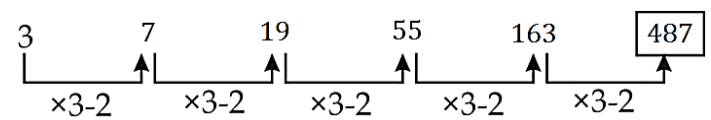

S103. Ans.(c)

Sol. 9 + 5 + 4 + 6 = 24

9 + 8 + 3 + 7 = 27

4 + 8 + 5 + 9 = 26

S104. Ans.(d)

Sol. Pattern in opposite sectors are

$$(1 \times 2) = 2$$

$$(4 \times 3) = 12$$

$$(9 \times 4) = 36$$

$$\text{Similarly, } (16 \times 5) = 80$$

S105. Ans.(a)

Sol. 37

S106. Ans.(a)

Sol.

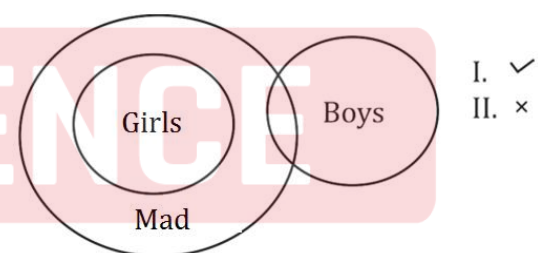

Only conclusion I follows

S107. Ans.(b)

Sol.

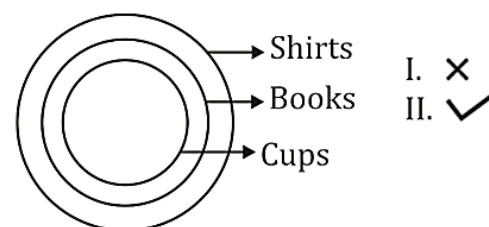

Only Conclusion II follows.

S108. Ans.(a)

Sol. 8 triangles

S109. Ans.(d)

Sol. B is the uncle of C.

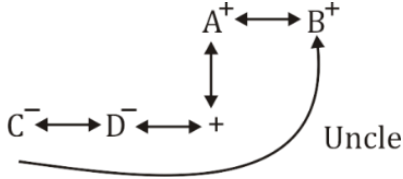

S110. Ans.(c)

Sol.

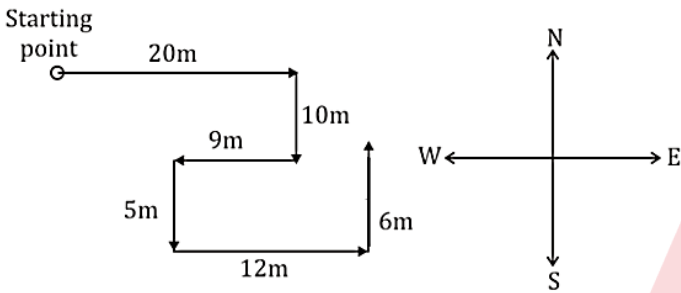

He is facing in North direction.

S111. Ans.(a)

Sol. ATQ,

$$\frac{A}{B} = \frac{3x + 4}{4x + 4} = \frac{11}{13}$$

$$\Rightarrow x = 1.6$$

So, present age of B = $4 \times 1.6 = 6.4$ years

S112. Ans.(c)

Sol.

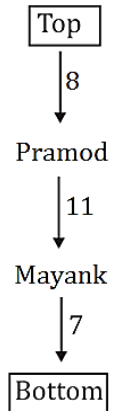

Total people in the row
= $8 + 1 + 11 + 1 + 7 = 28$

S113. Ans.(c)

Sol.

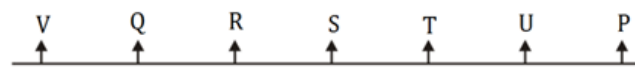

S114. Ans.(b)

Sol.

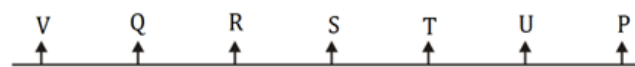

S115. Ans.(c)

Sol.

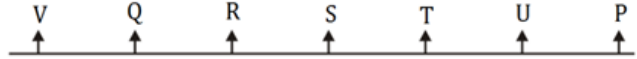

S116. Ans.(c)

Sol. Some clerks may be government employees and some may be educated. Similarly, some government employees may be clerk and educated.

S117. Ans.(c)

Sol. $12 - 6 + 4 \times 10 \div 16$

$$\Rightarrow 12 \times 6 \div 4 - 10 + 16$$

$$\Rightarrow 18 - 10 + 16$$

$$\Rightarrow 34 - 10$$

$$\Rightarrow 24$$

S118. Ans.(b)

Sol. From the reverse alphabet series it is clear that, G is the correct answer.

S119. Ans.(d)

S120. Ans.(c)

S121. Ans.(a)

Sol.

Truth – Lie } Antonyms
Big – Small }

S122. Ans.(d)

$$\text{Sol. } 5 - 5^2 = 25$$

$$6 - 6^2 = 36$$

S123. Ans.(c)

Sol. -1 series

S124. Ans.(c)

Sol. All pairs are of opposite words except (Run-Fast)

S125. Ans.(c)

$$\text{Sol. } 11 - 12^2$$

$$13 - 14^2$$

$$17 - 18^2$$

$$15 - 16^2 = 256 \neq 246$$

S126. Ans.(c)

Sol. All are pair of opposite letters except GR.

S127. Ans.(d)

Sol. 4. Rather

5. Ratify

1. Read

3. Ready

2. Real

S128. Ans.(b)

Sol.

$$\begin{array}{cccccc}
 9 & 13 & 22 & 38 & 63 & 99 \\
 \downarrow & \downarrow & \downarrow & \downarrow & \downarrow & \\
 +4 & +9 & +16 & +25 & +36 & \\
 \downarrow & \downarrow & \downarrow & \downarrow & \downarrow & \\
 2^2 & 3^2 & 4^2 & 5^2 & 6^2 &
 \end{array}$$

S129. Ans.(c)

Sol. $P \xrightarrow{+2} R \xrightarrow{+2} T \xrightarrow{+2} V \xrightarrow{+2} X$
 $C \xrightarrow{+3} F \xrightarrow{+4} J \xrightarrow{+5} O \xrightarrow{+6} U$
 $K \xrightarrow{+2} M \xrightarrow{+2} O \xrightarrow{+2} Q \xrightarrow{+2} S$

S130. Ans.(d)

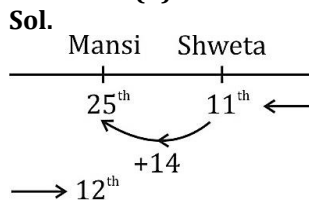

∴ Total no. of girls in the row

$$= 25 + 12 - 1$$

$$= 36$$

